

GLOMEX®

The best in marine antennas



since 1984

2024 CORPORATE CATALOGUE

You are never alone on the water





INDEX

▶ WEBBOAT COASTAL INTERNET	12-33
▶ SAT TV	34-69
▶ DVB-T2	70-93
▶ VHF	94-135
▶ AIS	136-139
▶ AM-FM	140-141
▶ CB	142
▶ MOUNTS & ACCESSORIES	144-163
▶ GROUND PLATES	164-167
▶ EXTENSIONS	168-175
▶ CONNECTORS E COAX CABLES	176-192
▶ GLOMEASY VHF	194-209
▶ GLOMEASY FM	210-213
▶ GLOMEASY AIS	214-219
▶ GLOMEASY DAB	220-221
▶ GLOMEASY ACCESSORIES	222-239
▶ ZIGBOAT	240-252
▶ PROMARINE VHF	254-263
▶ PROMARINE HF/SSB	264-265
▶ PROMARINE WI-FI	266-267
▶ PROMARINE ACCESSORIES	268-285
▶ SUPERGAIN TV	286-301

COMPANY PROFILE

Glomex is an Italian company and a world leader in the production of antennas and entertainment systems for the marine industry. It was founded in 1984 in Ravenna, with the ambition to improve the reliability of maritime telecommunications and offer its customers product and service quality, professionalism, technological innovation and style.

Nowadays, Glomex is a strong company that has established business partnerships all over the world, with its own distributors and with the largest international boatbuilders. Paying attention to the quality of raw materials and production processes, Glomex has interpreted the real needs of professional and amateur customers, always guaranteeing radio contact with land, reception of satellite and terrestrial TV signals, stable and fast internet connection. We do everything to carry on our motto: You are never alone on the water!

COMPANY PROFILE



Glomex è un'azienda italiana leader mondiale nella produzione di antenne e sistemi di intrattenimento per l'industria nautica. È stata fondata nel 1984 a Ravenna, con l'ambizione di migliorare l'affidabilità delle telecomunicazioni marittime e di offrire ai propri clienti qualità dei prodotti e dei servizi, professionalità, innovazione tecnologica e stile.

Oggi Glomex è un'azienda solida che ha stabilito partnership commerciali in tutto il mondo, con i propri distributori e con i maggiori costruttori navali internazionali. Attenta alla qualità delle materie prime e dei processi produttivi, Glomex ha interpretato le reali esigenze della clientela professionale e amatoriale, garantendo sempre il contatto radio con la terraferma, ricezione di segnali televisivi satellitari e terrestri, connessione internet stabile e veloce. Facciamo di tutto per portare avanti il nostro motto: You are never alone on the water!

PROFIL SOCIÉTAIRE

Glomex est une entreprise italienne leader mondial dans la production d'antennes et de systèmes de divertissement pour l'industrie nautique. Elle a été fondée en 1984 à Ravenne, avec l'ambition d'améliorer la fiabilité des télécommunications maritimes et d'offrir à ses clients une qualité de produits et de services, du professionnalisme, de l'innovation technologique et du style. Aujourd'hui, Glomex est une entreprise solide qui a établi des partenariats commerciaux dans le monde entier, avec ses distributeurs et avec les principaux constructeurs navals internationaux. Soucieuse de la qualité des matières premières et des processus de production, Glomex a su répondre aux véritables besoins de sa clientèle professionnelle et amateur, garantissant toujours le contact radio avec la terre, la réception de signaux télévisés satellitaires et terrestres, ainsi qu'une connexion internet stable et rapide. Nous faisons tout pour honorer notre devise: You are never alone on the water!



- ◀  Automated vertical warehouse
-  Entrepôt vertical automatisé
-  Magazzino verticale automatizzato

LIFETIME WARRANTY

- ▶ Glomex VHF, CB, Omnidirectional DVB-T2 TV, AM/FM, ORBCOMM, AIS, Glomeasy, Mobile Phone and their related mounts and accessories carry a LIFETIME WARRANTY;
- ▶ Glomex Commercial antennas range carries a 5-years Limited Warranty;
- ▶ Glomex Directional DVB-T2 TV antennas carries a 3-years Limited Warranty;
- ▶ Glomex weBBoat and Satellite DVB-S2 TV antennas range carry a 2-years Limited Warranty.

Glomex is the only company in the nautical sector that offers a lifetime warranty on a most of its products. Glomex warrants its products (for VHF, CB, TV, AM/FM, ORBCOMM, AIS and MOBILE PHONE) and related mounts to be free of production defects for as long the products remain the property of the original purchaser. Glomex commits itself to repair and to replace the products that, after inspection, show conformity defects, relating to materials and to working and production processes. No material will be repaired or replaced without written authorization from Glomex or its assigned representatives. Glomex is in no event liable for consequential damages, installation costs or costs of any nature incurred as a result of the use of the products manufactured by Glomex, whether used in accordance with instruction and maintenance or not. Glomex is not liable for repair or replacement of any products damaged by lightning or any other natural phenomenon or incorrect installation including reverse polarity connections. Proof of purchase is required and all shipping costs of the material returned are at claimer's charge.

GARANZIA A VITA

- ▶ Le antenne Glomex VHF, CB, TV Terrestri Omnidirezionali, AM/FM, ORBCOMM, AIS, Glomeasy, per cellulari ed i relativi supporti hanno la GARANZIA A VITA;
- ▶ Le antenne per imbarcazioni commerciali di Glomex hanno una garanzia limitata di 5 anni;
- ▶ Le antenne TV Terrestri direttive di Glomex hanno una garanzia limitata di 3 anni;
- ▶ weBBoat e le antenne TV Satellitari di Glomex hanno una garanzia limitata di 2 anni.

Glomex è l'unica azienda nel settore nautico ad offrire una garanzia a vita sulla maggior parte dei suoi prodotti. Glomex garantisce le proprie antenne (VHF, CB, TV, AM/FM, ORBCOMM, AIS e PER CELLULARI) e i relativi supporti contro i difetti di fabbricazione, fin quando i prodotti rimangono di proprietà dall'acquirente iniziale. Glomex si impegna a riparare o sostituire i prodotti che, dopo un accurato controllo, presentino difetti di conformità dei materiali e di lavorazione imputabili al processo di fabbricazione. Nessun prodotto potrà essere riparato o sostituito senza un'autorizzazione scritta da Glomex, o dai suoi rappresentanti autorizzati. Glomex non è responsabile dei danni indiretti, dei costi d'installazione o dei costi di altra natura derivanti dall'utilizzo dei suoi prodotti, indipendentemente dal fatto che siano state seguite, o meno, le istruzioni d'uso e manutenzione. Glomex non risponde dei prodotti danneggiati da fulmini o da qualsiasi altro fenomeno naturale o da un'errata installazione, incluse le connessioni a polarità invertite. È necessario esibire la prova d'acquisto e tutti i costi di trasporto del materiale reso sono a carico del richiedente.

GARANTIE À VIE

- ▶ Les antennes Glomex VHF, CB, TV TNT Omnidirectionnelle, AM/FM, ORBCOMM, AIS, Glomeasy, Téléphones Mobiles et ses supports sont livrées avec la GARANTIE À VIE;
- ▶ Les antennes Commerciales de Glomex sont livrées avec une garantie limitée de 5 ans;
- ▶ Les antennes TV TNT directionnelles de Glomex sont livrées avec une garantie limitée de 3 ans;
- ▶ Le weBBoat et les antennes TV DVB-S2 satellites de Glomex sont livrées avec une garantie limitée de 2 ans.

Glomex est la seule entreprise du secteur nautique qui offre une garantie à vie sur la plupart de ses produits. Glomex garantit ses antennes (VHF, CB, TV, AM/FM, ORBCOMM, AIS et TÉLÉPHONES MOBILES) et ses supports contre d'éventuels défauts de fabrication, aussi longtemps que le produit reste la propriété de l'acheteur initial. Glomex s'engage à réparer et à remplacer les produits, qui après un soigneux contrôle, présentent des défauts de conformité des matériaux et des défauts de fabrication. Aucun produit ne pourra être réparé ni remplacé sans autorisation écrite de Glomex ou de ses représentants autorisés. Glomex décline toute responsabilité en cas de dommages indirects, de coûts d'installation ou de frais de tout autre nature résultant de l'utilisation de ses produits, indépendamment du fait que le mode d'emploi et les conseils concernant l'entretien aient été suivis ou non. Glomex ne pourra être tenue à réparer ou à remplacer tout produit endommagé par la foudre ou par tout autre phénomène naturel ou bien par une mauvaise installation y compris les inversions de polarité. Une preuve d'achat sera exigée et tous les coûts d'expédition du matériel retourné seront à la charge du demandeur.



LIFETIME WARRANTY





test lab 3

🇬🇧 **THE PRODUCTS WITH THE TLT LOGO HAVE BEEN TESTED AT SEA ON THE GLOMEX TEST LAB TLT** (acronym for Test Lab Tested) is the abbreviation carried by the Glomex products, which have undergone rigid quality tests in marine environment and on board of the Test Lab, before being traded. The Test Lab is a boat arranged with all necessary installation for a direct test on Glomex product reliability. Before being placed on board the Test Lab, Glomex products pass resistance tests (UV-ray exposure, mechanical, electric and electronic strain) realized for one year directly inside the company. At the end of this complex trial, the Glomex products pass to the Test Lab in order to faithfully reproduce the conditions to which an antenna is exposed during cruising and to test their real performances. The acronym TLT is then synonymous with research, development, experimentation and quality assurance.

🇮🇹 **I PRODOTTI CON IL LOGO TLT SONO STATI TESTATI IN MARE SUL GLOMEX TEST LAB TLT**

(acronimo di Test Lab Tested) è la sigla riportata sui prodotti Glomex che sono stati sottoposti a rigidi test di qualità in ambiente marino, a bordo del Test Lab, prima di essere immessi sul mercato. Il Test Lab è un'imbarcazione allestita con tutti gli impianti necessari per collaudare direttamente sul campo l'affidabilità dei prodotti Glomex. Prima di arrivare a bordo del Test Lab i prodotti Glomex devono superare i test di resistenza (ai raggi UV, meccanica, elettrica ed elettronica) realizzati direttamente in azienda per un anno intero. Solo a termine di questo complesso processo di verifica, i prodotti Glomex vengono trasferiti a bordo del Test Lab per riprodurre fedelmente le sollecitazioni a cui un'antenna è sottoposta nel corso della navigazione, e testarne le effettive performances. L'acronimo TLT, quindi, è sinonimo di ricerca, sviluppo, sperimentazione e garanzia di qualità.

🇫🇷 **LES PRODUITS AVEC LE SIGLE TLT ONT ÉTÉ TESTÉS EN MER SUR LE BATEAU TEST LAB DE GLOMEX TLT**

(acronyme de Test lab Tested, testé en laboratoire) est le sigle utilisé sur les produits Glomex qui ont été soumis à de sévères tests de qualité en environnement marin et à bord du Test Lab, avant d'être commercialisés. Le Test Lab est un bateau équipé de toutes les installations nécessaires pour contrôler directement en mer la fiabilité des produits Glomex. Avant d'arriver à bord du Test Lab, les produits Glomex doivent passer des tests de résistance (mécanique, électrique et électronique, ainsi qu'aux rayons UV) réalisés pendant un an directement à l'intérieur de l'usine Glomex. C'est seulement au terme de ce processus complexe de contrôle que les produits Glomex sont transférés au Test Lab, afin de reproduire fidèlement les efforts auxquels une antenne est exposée au cours de la navigation et d'en tester ses performances réelles. L'acronyme TLT est donc synonyme de recherche, de développement, d'expérimentation et de garantie de qualité.



GENERAL

Transmitting and/or receiving equipments include three distinct parts, all equally important. These are: the transceiver, the coaxial cable with its connectors carrying the signal to or from the antenna, the antenna itself. At present cables, connectors and antennas often do not get the attention they deserve. Yet, their functionality has a notable effect on the performance of the whole system. A wrong antenna, poor quality coax cable or a low quality connector can waste the money spent for good equipment and a careful installation.

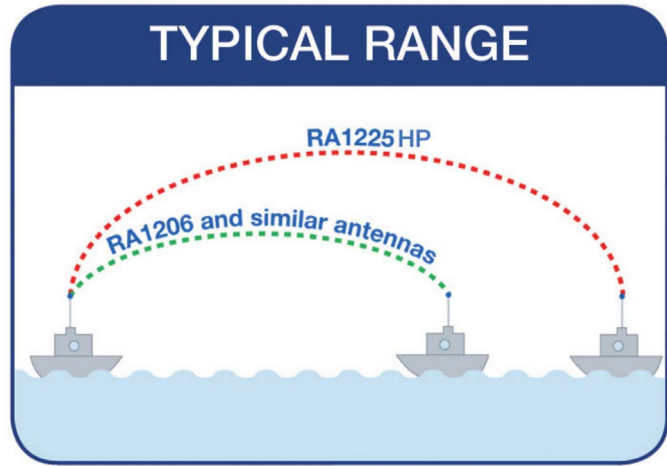

At every frequency, besides being free from obstacles, the antenna has to meet precise electrical and electronic requirements. Glomex has always made every effort to develop design and manufacturing qualities to improve antenna performance; besides complying with existing international standards. This means better performance of the entire transceiver system. When choosing an antenna, it is advisable to discuss with your dealer, about all the problems connected with the installation and the type of transceiver. This will let you tackle any problems before they arise. In case this sort of advice is not available, the information provided below should be helpful in selecting the right antenna.

HEIGHT

For VHF and UHF transmission range, the higher the antenna is located, better are the performances. Following such instructions it will be easy to make the right choice, original Glomex cables and accessories as well as the correct installation will be then decisive factors for obtaining the best result.

GAIN

It is the most important specs of the antenna. It is shown in DB; at the higher is the figure, the greater is the range. On the other hand, a high gain decreases the radiation pattern; this means that low gain antennas are less influenced by rolling and pitching of a boat; increasing the gain, the movement of the boat may cause a temporary signal's reduction. These are the reasons why on planning boats it is suggested to install high gain antennas, while on sailboats, with the masthead subject to swaying, the best would be, whenever possible, an antenna ground plane (RA108).

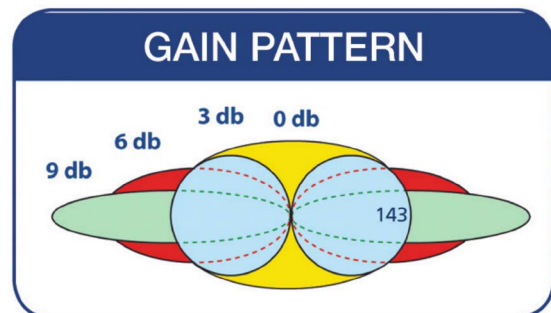

POLARIZATION

Each antenna has its own polarization, and also its preferential working plane, to be respected as much as possible. For example VHF, SSB, Loran, CB and cell-phone antennas have a vertical polarization and decrease gradually their gain, increasing their inclination; furthermore the factor is influenced by the frequency, gain losses are greater with high frequencies and progressively diminish reducing the frequency. Accordingly with the great majority of the stations, the TV antennas have a horizontal polarization, it is therefore necessary to install them in such a position. The incidence of motion is less evident with the omnidirectional models; the directional models have a reception angle max 60° that gives excellent performance if the antennas are correctly oriented but can easily lose the signal due to rolling, pitching or inclination. All this means television antennas must be installed horizontally and other antennas as much vertical as you possible.

MOUNTS, ACCESSORIES AND INSTALLATION

Quite often, the importance of accessories and installation is neglected. Glomex accessories are carefully conceived to offer the correct solution to any installation problem. They are the result of long experience and testing, with special attention to the new technologies and to the needs of the users. This catalogue provides all the information for the correct choice, your dealer and technician can provide precise specifications.

COAX CABLE CUTTING

Cutting the Glomex antenna coax cable is not a problem, just remember that a shorter cable enhance the performance of the antenna. The cable can be cut following a simple rule, do not cut the cable less than 2 mts (7') on VHF antenna. Avoid to cut the cable on CB and TV Antennas.

DC GROUND

It's referred to the design of the antenna, to avoid static electricity build-up on the antenna element, in order to reduce the noises on the receiver. When tested with an ohm-meter all Glomex VHF, cell-phone and CB Antennas will show continuity. All Glomex VHF and CB antennas have a built-in DC ground.

SWR (Stationary Wave Return)

All the SWR ratios indicated in this catalogue depend on the antenna location on the boat. All antennas have to be clear in all directions and at least 1 meter away from metallic parts. The SWR, when tested, should not exceed 1:1,3 with the antenna installed on the boat.



GENERALITÀ

Un apparato trasmittente e/o ricevente è composto da tre parti distinte: l'apparecchio ricetrasmittente, il cavo coassiale ed i connettori di collegamento all'antenna.

Cavi, connettori ed antenna, sono ancora oggi, elementi spesso trascurati, eppure influenzano molto le prestazioni. Per ogni frequenza, l'antenna, oltre ad essere libera in ogni direzione, deve avere precisi requisiti elettrici ed elettronici e Glomex è da sempre impegnata per il costante sviluppo e la ricerca di nuove soluzioni evolutive.

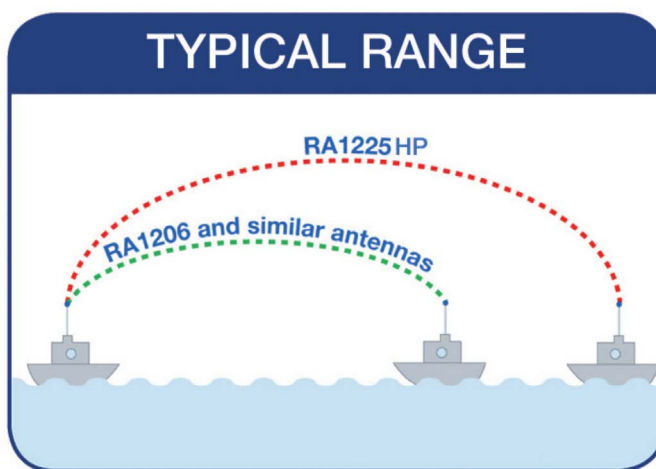

Nella scelta di un'antenna è opportuno discutere con il dealer e/o l'installatore, il dettaglio del montaggio in relazione all'apparato scelto. Se ciò non è possibile, alcuni chiarimenti che seguono possono essere utili come criteri di base nella selezione dell'antenna giusta.

ALTEZZA

Per le trasmissioni VHF e UHF, in genere a maggiore altezza dell'antenna corrispondono migliori prestazioni. Per ogni configurazione abbiamo quindi provveduto a rendere schematicamente l'imbarcazione ottimale di utilizzo di ogni antenna Glomex. Seguendo tale indicazione difficilmente si compiono scelte errate: saranno la scelta degli accessori e dei cavi originali Glomex e la fase dell'installazione fattori determinanti per il miglior risultato pratico.



GUADAGNO

È il dato saliente delle caratteristiche tecniche di un'antenna. È espresso in dB e con il suo crescere aumenta la portata della comunicazione. D'altra parte un guadagno elevato riduce l'ampiezza del diagramma di radiazione: ciò significa che con bassi guadagni la ricezione e la trasmissione sono meno influenzate da rollio e beccheggio anche se con portata minore, man mano che il gain cresce si ha una portata maggiore ma rollio o beccheggio possono portare ad una diminuzione del segnale. Per questi motivi su barche plananti è consigliabile l'impiego di antenne ad alto guadagno. Su imbarcazioni a vela invece è consigliabile un'antenna di tipo ground plane. (RA108)

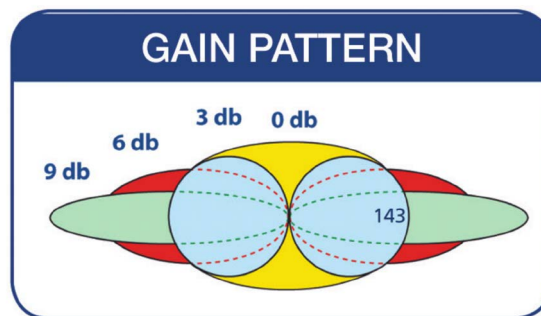

POLARIZZAZIONE

Ogni antenna ha una sua polarizzazione, ovvero un piano preferenziale di funzionamento che deve essere rispettato il più possibile. Per esempio, le antenne VHF, per telefoni cellulari e SSB hanno polarizzazione verticale e diminuiscono il loro guadagno all'aumentare dell'inclinazione. Inoltre il fenomeno è influenzato dalla frequenza: le perdite di guadagno sono maggiori alle alte frequenze e diminuiscono poi con la frequenza. Le antenne TV hanno polarizzazione orizzontale ed è quindi indispensabile che lavorino in tale posizione. Nel caso delle omnidirezionali il fenomeno è meno evidente che nel caso delle direzionali, che hanno un angolo di ricezione tanto "stretto" da permettere eccellenti risultati se ben orientate ma che, per rollio, beccheggio o inclinazione, possono facilmente "perdere" il segnale.

SUPPORTI ACCESSORI E INSTALLAZIONE

L'importanza di questi particolari è spesso sottovalutata! La serie degli accessori Glomex è stata studiata per risolvere in modo corretto qualsiasi problematica di installazione. Anche per tali importanti complementi dealer e tecnici sono in grado di dare utili e precisi suggerimenti.

ACCESSORI E CAVI COASSIALI

Accorciare i cavi coassiali Glomex, non dovrebbe crearvi dei problemi. Ricordate solamente che più un cavo è corto, più aumentano le performance dell'antenna. Il cavo può essere tagliato seguendo una semplice regola, non tagliare i cavi più corti di due metri nelle antenne VHF. Evitare di accorciare i cavi delle antenne C.B. Non esistono problemi, invece, con i cavi delle antenne televisive.

DC GROUND DELL'ANTENNA

Misurando con un tester in Ohm un'antenna si verifica che vi è un corto circuito. Tale soluzione costruttiva serve per ridurre le correnti statiche che si possono creare nell'antenna senza ricorrere ad un collegamento a massa e Glomex adotta questo schema per tutte le sue antenne. Grazie al circuito interno che minimizza le correnti statiche, le antenne Glomex non richiedono collegamenti a massa.

SWR (Stationary Wave Return)

È la parte di radiofrequenza che l'antenna non irradia a causa del ritorno di onde stazionarie. Un rapporto di 1.5:1 è considerato il massimo accettabile. Tutte le antenne Glomex hanno valori di SWR migliori di tale valore. Tuttavia, il ritorno di onde stazionarie dipende anche dalla posizione dell'antenna, che deve essere ad una distanza minima di 1 m da qualsiasi altro elemento metallico. In situazioni diverse, il valore di SWR misurato può differire da quello misurato da Glomex nel collaudo.

GENERALITES

Un appareil de réception ou de radio transmission est composé de trois parties distinctes, toutes trois importantes: l'appareil Emetteur / Récepteur, le câble coaxial avec l'ensemble de connecteurs et l'antenne. Câbles, connecteurs et antennes sont encore aujourd'hui des éléments souvent négligés. Et pourtant leur bon fonctionnement à une grande importance, notamment sur tout le système. Une antenne ou un câble coaxial de mauvaise qualité peut rendre inutile l'investissement et les soins portés à l'installation de l'appareil. Pour chaque fréquence, l'antenne, en plus d'être performante dans toutes les directions, doit avoir les qualités électriques et électroniques requises. Glomex s'est toujours employé à respecter toutes ces normes internationales déjà existantes, développant ainsi les qualités du projet et de la construction qui peuvent contribuer à mettre en valeur les prestations de l'antenne et ainsi de la totalité de l'appareil Emetteur / Récepteur. Pour le choix d'une antenne, il est opportun de discuter avec le vendeur ou l'installateur des problèmes spécifiques concernant le montage de l'appareil choisi. Au cas où cela ne serait pas possible, les informations qui suivent peuvent être utiles comme critères de base pour la sélection de l'antenne.

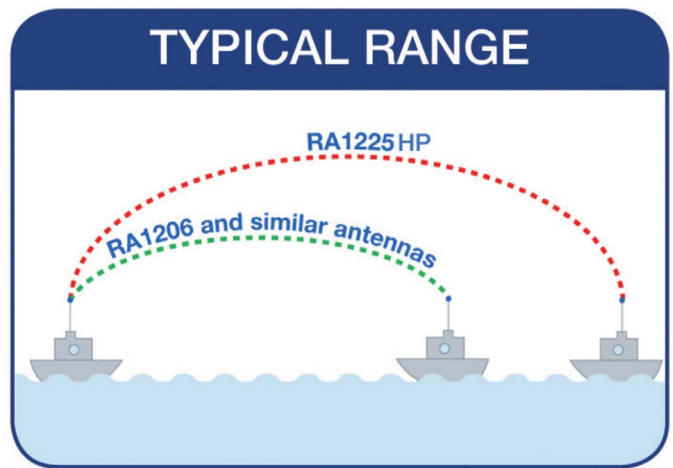

HAUTEUR

Pour les transmissions VHF et UHF, de manière générale, plus l'antenne est grande, meilleurs sont les résultats. En suivant de telles indications, de mauvais choix ne peuvent être commis. En choisissant les accessoires et les câbles d'origine Glomex et en étant attentif aux différentes phases de l'installation, on obtient les meilleures performances.

GAIN

C'est la caractéristique technique principale d'une antenne. Il est exprimé en DB, plus il augmente, plus la portée utile de la communication augmente. Par ailleurs, un gain élevé réduit l'ampleur du diagramme de rayonnement. Ce qui signifie qu'avec des gains bas, la réception et la transmission est moins parasitée par le roulis et le tangage même si la portée est inférieure. Au fur et à mesure que le gain augmente, on a une portée meilleure, mais les mouvements du bateau, roulis, tangages, peuvent provoquer une atténuation temporaire du signal reçu. Pour ces raisons, sur les bateaux à moteur, qui sont moins sujets aux roulis et aux tangages, il est conseillé d'utiliser les antennes à haut gain. Au contraire, sur les voiliers où la tête de mât peut subir des oscillations importantes, il est préférable d'utiliser, dans la mesure du possible, des antennes plan de masse (RA108).

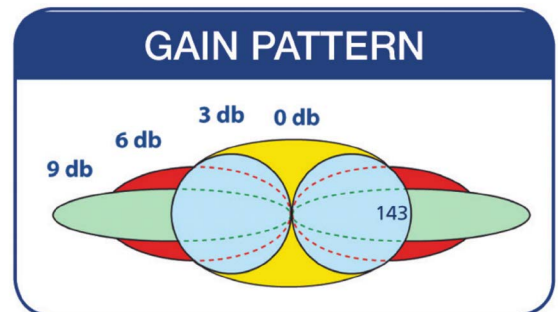

POLARISATION

Chaque antenne a une polarisation, c'est à dire un plan préférentiel de fonctionnement qui doit être respecté. Par exemple, les antennes VHF, radiotéléphone cellulaire, BLU, LORAN, ont des polarisations verticales et diminuent progressivement leur gain lorsque l'inclinaison augmente.

De plus, le phénomène est accentué par la fréquence. Les antennes TV ont, en accord avec la majorité des stations émettrices, des polarisations horizontales et il est donc indispensable de travailler selon cette polarisation. Dans le cas d'antennes omnidirectionnelles, le phénomène est légèrement moins évident que pour les antennes directionnelles, qui ont un angle de réception de 60°, et ont d'excellents résultats si correctement orientés, mais qui peuvent facilement perdre le signal en cas de roulis ou tangages. Cela signifie que les antennes TV doivent être installées le plus verticalement possible.

ROTULES, ACCESSOIRES ET INSTALLATION

L'importance de ces détails est trop souvent sous-évaluée. La série des accessoires Glomex a été très attentivement étudiée afin de résoudre correctement tout problème d'installation. Ils sont le fruit d'une longue expérimentation pratique et suivent une évolution constante au fur et à mesure que des nouvelles technologies ou exigences émergent. Etant donné l'importance de ces accessoires, ce catalogue fournit toutes les données nécessaires pour permettre un choix correct. Vendeurs et techniciens sont également en mesure de vous donner des conseils utiles et précis.

COUPE DU CABLE COAXIAL

Couper le câble des antennes Glomex n'est pas un problème, mais coupé un câble trop court, réduit les performances de l'antenne. Laisser 2 mètres minimum de câble pour une antenne VHF. Eviter de couper le câble d'une antenne CB ou TV.







LIAISON MASSE

La qualité de fabrication des antennes évite l'accumulation d'électricité statique sur l'élément actif et réduit de ce fait, le bruit au niveau du récepteur. En conséquence, le test des antennes VHF ou CB Glomex avec un ohmmètre donne une mesure de continuité. Liaison masse ne veut pas dire que l'antenne doit être connectée à la masse mais que les antennes Glomex VHF et CB GSM sont couplées la masse du câble coaxial.

SWR (Stationary Wave Return)

Toutes les mesures indiquées sur ce catalogue dépendent de la position de l'antenne sur votre bateau. Toutes les antennes doivent être dégagées au maximum et éloignées d'un mètre au minimum de toute pièce métallique. Le SWR, quand on le teste, ne doit pas excéder 1 :1,3 avec l'antenne installée sur le bateau.

Glomex 5G/4G/Wi-Fi Coastal & Ocean Interent system Selection Guide

Boat type		Unit			Slot SIM		Ethernet ports		Speed 5G + 4G/LTE		Reception range 5G + 4G/LTE		Geographical Area	
Megayacht Commercial	Medium-small	All-in-one	Indoor	Indoor + external antennas	Single	Dual	2	4G - Cat 6 up to 300 Mbps (DL)	5G/4G - Cat 16 up to 2.5 Gbps (DL)	Up to, miles	IT1104HS	IT1104HS/US	Europe, Middle East, Africa, Asia, Suid America, Oceania	Nord America
	✓	✓	✓	✓	✓	✓	✓	✓	✓	15	IT1104HS	IT1104HS/US		
	✓	✓	✓	✓	✓	✓	✓	✓	✓	25 ⁺	Global: IT1205PLUS			
	✓	✓	✓	✓	1 ROUTER 4 SIM	✓	✓	✓	✓	25 ⁺	Global: IT1205PLUS/SE			
	✓	✓	✓	✓	✓	✓	✓	✓	✓	10	IT1304HS	IT1304HS/US		
	✓	✓	✓	✓	✓	✓	✓	✓	✓	20	IT1304HSEXT	IT1304HS EXT/US		
	✓	✓	✓	✓	✓	✓	✓	✓	✓	15	Global: IT1405PRO			
	✓	✓	✓	✓	✓	✓	✓	✓	✓	25 ⁺	Global: IT1405PROEXT			





weBoat 4G Lite High Speed

4G/Wi-Fi High Speed Single SIM outdoor system to surf the web up to 15 miles from the coast

Category: All-in-One outdoor unit

Subcategory: Single SIM / Small-medium fiberglass boats / 15 miles

Code: IT1104HS, IT1104HS/BK



weBoat® 4G Lite High Speed is COMPACT ALL-IN-ONE COASTAL INTERNET 4G/Wi-Fi single SIM integrated systems to surf the web at sea (up to approximately 15 miles from the coast) and in marginal signal areas on land. The system provides the perfect balance between small dimensions and great performance, ensuring stable and high speed connections. weBoat® 4G Lite High Speed is equipped with two 4G diversity antennas, two 2.4GHz MIMO Wi-Fi antennas, and a super-fast 4G/Wi-Fi router that creates a safe hotspot on the boat and motorhome.

weBoat® 4G Lite High Speed ensures high connection speed, up to 300Mbps in DL, that allows you to surf the web, make video calls, watch streaming platform along the coast. Moreover, it has a new double power processor and the carrier aggregation function for optimizing the speed of data transfers and taking advantage of all the potential offered by the net. Thanks to the weBoat® 4G Lite systems, you can use up to 24 different devices simultaneously without any degradation to the signal or performance.

The units built-in advanced switching software allows the user to save money on costly roaming and overage charges by automatically switching to Wi-Fi when available. The weBoat® 4G Lite are true Plug&Play devices with minimal setup and only one power lead for the antenna (10-30Vdc).

Moreover, all functions of the unit are managed by the iOS/Android free App, such as automatic APN, SMS management, monitoring the internet data consumption, auto-

INTERNET ANTENNAS:	2 x 4G + 2 x 2.4GHz MIMO Wi-Fi antennas
DC POWER SUPPLY:	9/30Vdc
ETHERNET PORTS:	2 (1 WAN + 1 LAN)
LTE CAT6:	Up to 300Mbps in download
DC-HSPA+:	Max 42Mbps in download
WIRELESS MODE:	IEEE 802.11b/g/n
CPU:	650MHZ (instead of 400MHZ of standard weBoat Lite)
RAM:	128MB (instead of 64MB of standard weBoat Lite)
DIMENSIONS (DIAM.X H):	140 x 200 mm
WEIGHT:	0,9 kg
SIM CARD SLOT:	SINGLE SIM
AVERAGE CONSUMPTION:	500mA @ 12 Vdc
AUTOMATIC APN	
SMS MANAGEMENT FUNCTION	
V-SAT/SAT INTERNET AUTOSWITCH MODE	
SWITCHING CELLULAR DATA TO EXTERNAL WI-FI	
WNCRYPTED REAL-TIME PEER-TO-PEER CONNECTION FOR REMOTE SET-UP AND SERVICE	
AUTOMATIC SWITCH FROM WI-FI NETWORKS TO 4G	
4G BACKUP WAN FUNCTION	
ANDROID AND IOS APP FOR AN EASY CONTROL	
EASY INSTALLATION REQUIRE ONLY POWER SUPPLY CONNECTION 12/24V	
UV RESISTANT DOME	
<i>More info on www.glomex.it</i>	

matic switching mode with onboard satellite internet devices/V-SAT, and an encrypted real-time peer-to-peer connection for remote set-up and service.

code: IT1104HS (for Europe, Middle East, Africa, Asia, South America, Australia and New Zealand)

code: IT1104HS/US (for North America)



weBBoat® 4G Lite High Speed est le système intégré COASTAL INTERNET 4G/Wi-Fi unique SIM compact et All-in-ONE conçu par Glomex pour naviguer sur Internet à haute vitesse jusqu'à 15 miles de la côte et sur la terre ferme où il y a une faible couverture du réseau Internet. Il offre un équilibre parfait entre petite taille et grande performance assurant des connexions stables et rapides. weBBoat® 4G Lite High Speed assure une grande vitesse de connexion, jusqu'à 300Mbps en DL, ce qui vous permet de naviguer sur le web, faire des appels vidéo, regarder la plate-forme de streaming le long de la côte. Il est également équipé d'un nouveau processeur à double puissance et de la fonction "carrier aggregation" pour optimiser la vitesse de transfert des données et exploiter tout le potentiel offert par Internet.

weBBoat 4G Lite High Speed est équipé de deux antennes 4G Diversity, deux antennes Wi-Fi 2.4ghz MIMO, et un routeur 4G/Wifi qui reçoit le signal internet et le redirige à l'intérieur du bateau ou du camping-car avec un réseau Wifi sécurisé qui peut être utilisé simultanément par 24 appareils différents. En outre, si un réseau Wi-Fi connu est disponible, weBBoat® 4G Lite se connecteront automatiquement à elle pour limiter les coûts de la connexion Internet. weBBoat® 4G Lite sont des produits Plug&play et, pour son fonctionnement, il n'a besoin que d'un câble d'alimentation de 10 à 30 Vdc. En outre, toutes les fonctionnalités des systèmes weBBoat® 4G Lite sont faciles à gérer via l'application gratuite pour les appareils iOS et Android, comme le choix automatique de l'APN, la gestion des SMS, le suivi de la consommation internet, le mode de commutation automatique avec les dispositifs internet satellite/V-SAT à bord et une connexion chiffrée peer-to-peer en temps réel pour la configuration et l'assistance technique à distance.

weBBoat® 4G Lite High Speed è il sistema integrate COASTAL INTERNET 4G/Wi-Fi single SIM COMPATTO e ALL-in-ONE ideato da Glomex per navigare in internet ad alta velocità fino a 15 miglia dalla costa e nella terraferma dove è presente una scarsa copertura dalla rete internet. Offre il perfetto equilibrio tra dimensioni ridotte e grandi prestazioni assicurando connessioni stabili e veloci. weBBoat® 4G Lite High Speed assicura un'alta velocità di connessione, fino a 300Mbps in DL, che consente di navigare sul web, effettuare videochiamate, guardare la piattaforma di streaming lungo la costa. Inoltre è dotato di un nuovo processore a doppia potenza e della funzione di "carrier aggregation" per ottimizzare la velocità di trasferimento dei dati e sfruttare tutto il potenziale offerto da internet.

weBBoat 4G Lite High Speed è dotato di due antenne 4G Diversity, due antenne Wi-Fi 2.4GHz MIMO, e un router 4G/WiFi che riceve il segnale internet e lo ridireziona all'interno dell'imbarcazione o del camper con una rete WiFi protetta che può essere utilizzata contemporaneamente da 24 dispositivi differenti. Inoltre, se una rete Wi-Fi conosciuta è disponibile, weBBoat® 4G Lite si collegheranno automaticamente ad essa per limitare i costi della connessione internet. weBBoat® 4G Lite sono prodotti Plug&Play e, per il suo funzionamento, ha bisogno solamente di un cavo di alimentazione da 10 a 30 Vdc. Inoltre, tutte le funzionalità dei sistemi weBBoat® 4G Lite sono facili da gestire tramite l'App gratuita per i dispositivi iOS e Android, come la scelta automatica dell'APN, la gestione degli SMS, il monitoraggio del consumo internet, la modalità di commutazione automatica con i dispositivi internet satellitari/V-SAT di bordo e una connessione cifrata peer-to-peer in tempo reale per la configurazione e l'assistenza tecnica da remoto.

OPTIONAL ACCESSORIES



▲ ITM002 nylon mount for cross tree



▲ V9175OT nylon mount



▲ V9177 stainless steel mount

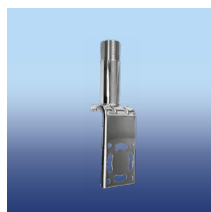

▲ V9176 electropolished stainless steel masthead L bracket

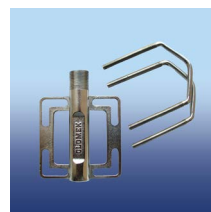

▲ V9171 electropolished stainless steel pipe mounting bracket



▲ ITAP001 Access point for metal/large boat.



NEW

weBBoat® Plus 5G is the new WORLDWIDE* Dual SIM 5G/Wi-Fi All-in-One Plug & Play Coastal internet system to get internet on board and a secure Wi-Fi hotspot inside and outside the boat thanks to the in-built 5G and Wi-Fi antennas for fast connection up to 25 miles from the coast. Now, you have an ultra-fast connection download speed on board: up to 2.5 Gbps. Moreover, if you sail in an area with no 5G signal coverage, the LTE CAT 16 unit allows you to have a 4G connection speed up to 1Gbps. 5G offers a connection with the same level of fibre, but totally wireless and therefore perfect to be used on board.

Inside the dome, there are 4 x high performance 5G and 2 x 2.4/5GHz MIMO Wi-Fi antennas for optimizing the speed of data transfers with a huge increase on the connection speed. That means that you can either watch streaming TV channels and platforms such as Netflix offshore, or work remotely on your boat, using internet connection as like you would be on the mainland. Equipped with the new revolutionary Glomex MIoT Routerboard platform with a super-powerful processor, that highly increases the connection speed compared to other existing internet systems.

Up to 32 different devices can be used simultaneously without any degradation to the signal or performance. The units built-in advanced switching software allows the user to save money on costly roaming and overage charges by automatically switching to Wi-Fi when available. The weBBoat® Plus 5G is a true Plug & Play device that requires minimal setup and only one power lead for the antenna which operates from 10-30 vDC. The Dual SIM architecture allows the user to have more choices for operation (i.e. different carriers for coverage, extra data if one card runs out, etc).

weBBoat Plus 5G

DUAL SIM 5G/WI-FI COASTAL INTERNET outdoor system to surf the web up to 25 miles from the coast

Category: All-in-One outdoor unit

Subcategory: Dual SIM / Small-medium fiberglass boats / over 25 miles

Code: IT1205PLUS, IT1205PLUS/BK



WORLDWIDE UNIT:	For Europe, Middle East, North and South Americas, Australia, New Zealand, Africa and Asia (except for China)
DIMENSIONS (DIAM.X H):	250 x 300 mm / 10x12"
WEIGHT:	1,2 kg / 2,65 lb
SIM CARD SLOT:	DUAL MICRO
INTERNET ANTENNAS:	4 x 5G + 2 x 2.4/5GHz MIMO Wi-Fi antennas
5G:	Up to 2.5Gbps in download
LTE CAT16:	Up to 1Gbps in download
WCDMA:	Max 42Mbps in download
CPU:	Arm Cortex-A7 800MHz
RAM:	256MB DDR3
POWER SUPPLY:	10/30 Vdc
AVERAGE CONSUMPTION:	150mA
AUTOMATIC SWITCH WI-FI REGISTERED NETWORKS TO 4G	
AUTOMATIC APN	
SMS MANAGEMENT FUNCTION	
V-SAT/SAT INTERNET AUTOSWITCH MODE	
SWITCHING CELLULAR DATA TO EXTERNAL WI-FI	
ENCRYPTED REAL-TIME PEER-TO-PEER CONNECTION FOR	
REMOTE SET-UP AND SERVICE	
<i>More info on www.glomex.it</i>	

weBBoat® Plus 5G has additional features such as Carrier aggregation. The new weBBoat Plus 5G takes advantage of the flexible bandwidth option in LTE and adds the capability to combine multiple bands of the carrier into one big channel. It can access a much bigger data pipe and therefore the achievable data rates improve significantly.

Carrier aggregation is supported by improvements to the unit technologies, to make the overall spectrum usage more efficient. automatic APN, SMS management/reading/sending to monitor internet consumption, automatic switching mode with onboard satellite internet devices/V-SAT and an encrypted real-time peer-to-peer connection for remote set-up and service that increase the performance and usefulness of your integrated system Coastal Internet.

weBBoat® Plus 5G est le nouveau système intégré COASTAL INTERNET 5G/Wi-Fi DUAL SIM conçu par Glomex pour naviguer sur Internet à haute vitesse, assurant des connexions stables et rapides jusqu'à environ 25 miles de la côte. weBBoa® Plus 5G est équipé de 4 antennes 5G qui reçoivent le signal internet et le redirigent à l'intérieur du bateau en fibre de verre avec un réseau Wifi sécurisé qui peut être utilisé simultanément par 32 appareils différents et autorisés. Grâce à weBBoat® Plus 5G vous avez une vitesse de téléchargement de connexion ultra-rapide à bord : jusqu'à 2,5 Gbps. De plus, si vous naviguez dans une zone sans couverture 5G, l'unité LTE CAT 16 permet d'avoir une vitesse de connexion 4G jusqu'à 1gbps. La 5G offre une connexion avec le même niveau de fibre, mais totalement sans fil et donc parfait pour être utilisé à bord. À l'intérieur du dôme, il y a 4 antennes 5G haute performance et 2 x 2.4/5ghz MIMO Wi-Fi pour optimiser la vitesse de transfert des données avec une énorme augmentation de la vitesse de connexion. Cela signifie que vous pouvez regarder des chaînes de télévision en streaming et des plates-formes comme Netflix offshore, ou de travailler à distance sur votre bateau, en utilisant la connexion Internet comme vous le feriez sur le continent.

En outre, si un réseau Wi-Fi connu est présent et disponible (par exemple le réseau Wi-Fi de la marine), weBBoat Plus 5G se connectera automatiquement à elle pour limiter les coûts de la connexion Internet. weBBoat® Plus 5G est un produit PLUG&PLAY qui ne nécessite qu'un câble d'alimentation de 10 à 30 volts et une/deux cartes Micro-sim pour la navigation sur Internet; tout cela rend le système particulièrement facile à installer. weBBoat® Plus 5G est également facile à utiliser grâce à la nouvelle application gratuite Glomex disponible gratuitement pour les appareils iOS et Android. weBBoat® Plus 5G a des fonctionnalités supplémentaires telles que la fonction "carrier aggregation" pour optimiser la vitesse de transfert de données et d'exploiter tout le potentiel offert par l'Internet, le choix automatique de l'APN, gestion/lecture/envoi des SMS pour surveiller la consommation d'Internet et mode de commutation automatique avec les appareils Internet satellite/V-SAT à bord et une connexion chiffrée peer-to-peer en temps réel pour la configuration et l'assistance technique à distance qui augmentent les performances et l'utilité de votre système intégré Coastal Internet.

weBBoat® Plus 5G è il nuovo sistema integrato COASTAL INTERNET 5G/Wi-Fi DUAL SIM ideato da Glomex per navigare in internet ad alta velocità, assicurando connessioni stabili e veloci fino a circa 25 miglia di distanza dalla costa. weBBoa® Plus 5G è dotato di 4 antenne 5G che ricevono il segnale internet e lo ridirezionano all'interno dell'imbarcazione in vetroresina con una rete WiFi sicura e protetta che può essere utilizzata contemporaneamente da 32 dispositivi differenti e autorizzati. Grazie a weBBoat® Plus 5G si dispone di una velocità di download di connessione ultra-veloce a bordo: fino a 2,5 Gbps. Inoltre, se navighi in un'area senza copertura 5G, l'unità LTE CAT 16 permette di avere una velocità di connessione 4G fino a 1Gbps. Il 5G offre una connessione con lo stesso livello di fibra, ma totalmente wireless e quindi perfetto per essere utilizzato a bordo.

All'interno della cupola, sono presenti 4 antenne 5G ad alte prestazioni e 2 x 2.4/5GHz MIMO Wi-Fi per ottimizzare la velocità di trasferimento dei dati con un enorme aumento della velocità di connessione. Ciò significa che è possibile guardare i canali TV in streaming e piattaforme come Netflix offshore, o lavorare in remoto sulla vostra barca, utilizzando la connessione internet come si farebbe sulla terraferma.

Inoltre, se una rete Wi-Fi conosciuta è presente e disponibile (ad esempio la rete Wi-Fi della marina), weBBoat Plus 5G si collegherà automaticamente ad essa per limitare i costi della connessione internet. weBBoat® Plus 5G è un prodotto PLUG&PLAY che necessita solamente di un cavo di alimentazione da 10 a 30 Volt e una/due schede Micro-SIM per la navigazione in internet; tutto questo rende il sistema particolarmente facile da installare. weBBoat® Plus 5G è anche facile da utilizzare grazie alla nuova App gratuita Glomex disponibile gratuitamente per i dispositivi iOS e Android. weBBoat® Plus 5G ha funzionalità aggiuntive come la funzione di "carrier aggregation" per ottimizzare la velocità di trasferimento dei dati e sfruttare tutto il potenziale offerto da internet, la scelta automatica dell'APN, gestione/lettura/invio degli SMS per monitorare il consumo internet e modalità di commutazione automatica con i dispositivi internet satellitari/V-SAT di bordo e una connessione cifrata peer-to-peer in tempo reale per la configurazione e l'assistenza tecnica da remoto che aumentano le prestazioni e l'utilità del tuo sistema integrato Coastal Internet.

OPTIONAL ACCESSORIES



▲ V9124 stainless steel masthead mount



▲ ITM001 nylon mount for cross tree



▲ V9177



▲ V9176



▲ ITAP001 Access point for metal/large boat.

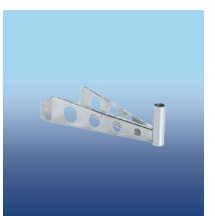

▲ IV9173TV Stainless steel masthead mount (diameter 25 mm/1)

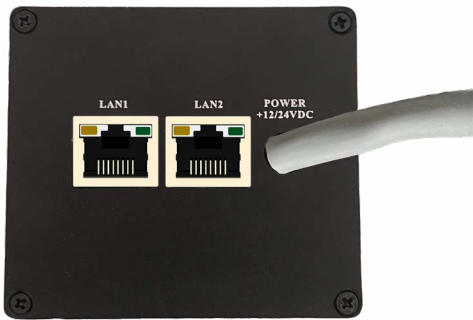

SIM Extender provides the user with the ability to have up to 4 SIM Cards on one-hand distance, while installing the Glomex weBBoat® at a distance of up to 100 m, connected with the RJ45 Ethernet cable.

The SIM Extender is equipped with two Ethernet ports, and the second Ethernet port can be used for direct connection to other devices or with Ethernet Switch, in case additional Ethernet ports are needed, or access point to play the Wi-Fi signal inside the boat.

The SIM Extender power supply is DC 12 or 24 volts. The status of the SIM on the SIM-Extender as well as from the App will be visible by observing the coloring of the LEDs in the front panel.

Sim Extender

Glomex weBBoat® Plus 5G is now available with Glomex SIM Extender providing the user with the ability to have up to 4 SIM Cards on one-hand distance and the ability to freely install the Glomex weBBoat® in an optimal location by connecting it with the RJ45 Ethernet cable up to 100 m long. This way you can maximize the performance in terms of navigation speed and distance to the coast.

The connection between Glomex weBBoat® Plus 5G and Glomex SIM Extender will be via Ethernet cable on the LAN port of the Glomex weBBoat® Plus 5G

Technical Specifications

- 1. SIM Extender supports up to 4 SIM cards:** Type Micro SIM. Only one can be active at a time.
- 2. Operating temperature:** -10°C to 50°C
- 3. Humidity:** 15% - 95% (No condensation)
- 4. SIM Extender can communicate with the weBBoat® Plus 5G up to a distance of 100m :** (Connection on the LAN port with Ethernet cable).
- 5. 2 LAN ports:** (one used for connection with the weBBoat® Plus 5G)
- 6. Reset button**
- 7. Power on/off button**
- 8. 12/24 Vdc power supply**

Led Status



- SIM activated and connected to the internet (blink: connection in progress)
- SIM verified
- Activated SIM not able to connect to the internet

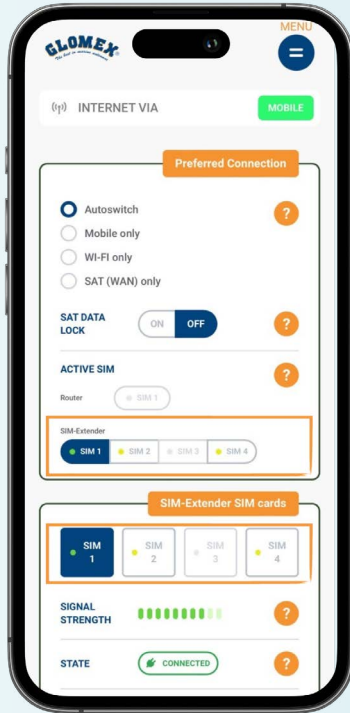

Control panel

Ability to select the active SIM between Router (1 SIM) and SIM Extender (4 SIM)

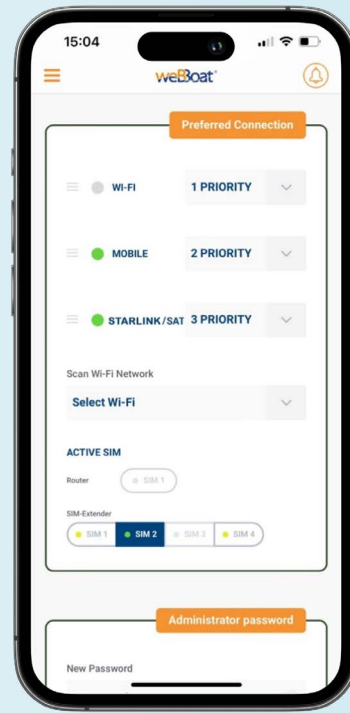

Advanced Settings

Ability to select active SIM and monitor the connection status of interfaces: Wi-Fi, Mobile, Starlink / SAT

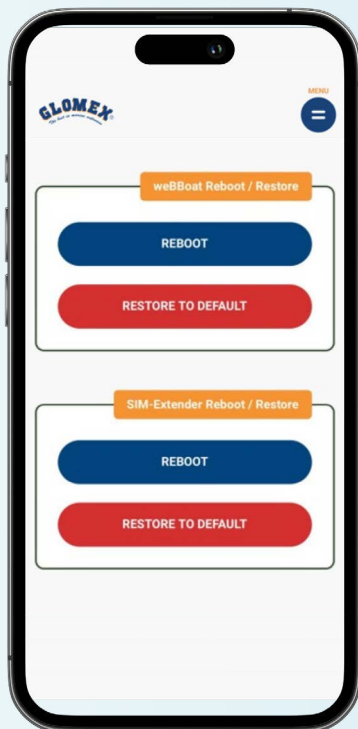

Reboot and Restore

Ability to restart or reset SIM Extender to default settings

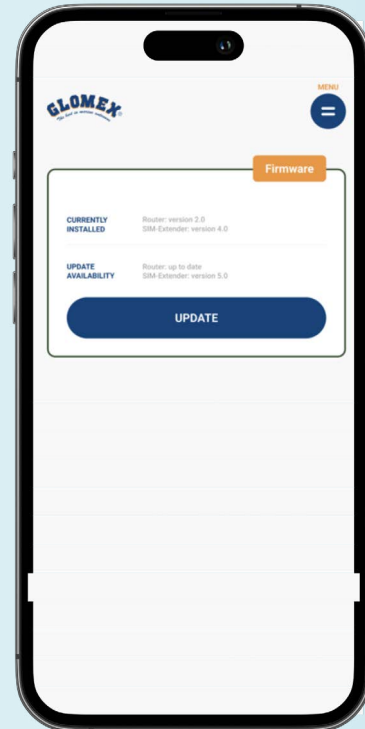

Firmware update

Ability to upgrade SIM Extender and Router Board Firmware with one click



IT5000

5G MIMO MOBILE ANTENNA IT5000 is GLOMEX TOP multi-band 5G/4G (LTE)/GSM/UMTS/GPRS high-performance antenna.

The ideal solution to interface with the weBBoat® Link PRO 5G (IT1405PRO) with a single antenna in a 250x300mm (10x12") radome with 4 SMA female pigtail terminals.

Two terminals refer to two dipole antennas optimized for frequencies from 1.5GHz to 6GHz and two others associated with a dual monopole antenna optimized for frequencies from 600MHz up to 6GHz. The IT5000 antenna can also be used in pairing with other 5G routers of any brand.

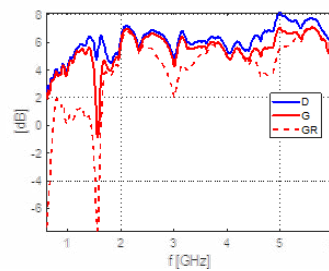
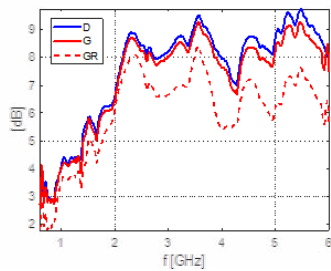
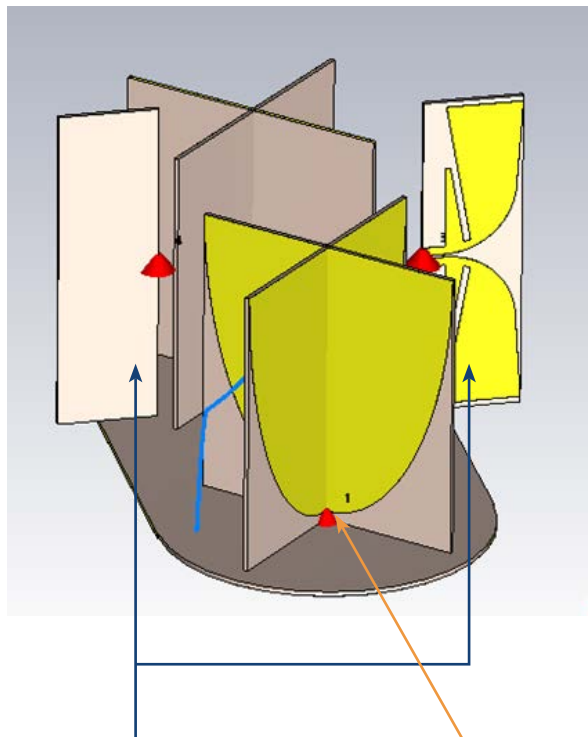

• Antenna a Dipolo installata Verticalmente

Monopolo (1)

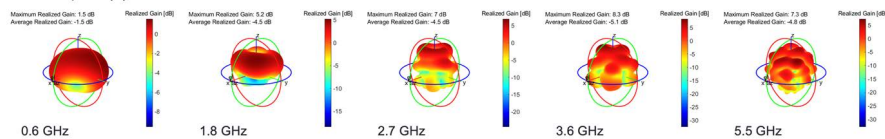

Dipolo (3)

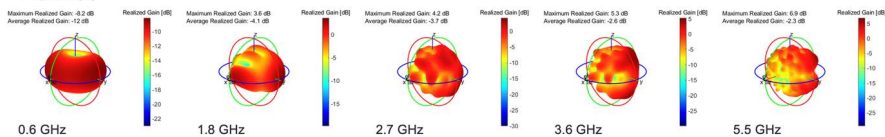





weBBoat Link

Single sim 4G/Wi-Fi ocean & coastal internet indoor unit for surfing the internet up to 10 miles

Category: Indoor unit

Subcategory: Single SIM / Small-medium fiberglass and metal boats / 10 miles

Code: IT1304



🇺🇸 weBBoat® Link (code IT1304) is the new Single SIM 4G/Wi-Fi indoor unit Coastal & Ocean internet system to get internet on your boat and a secure Wi-Fi hotspot inside and outside the boat using the in-built 4G and Wi-Fi antennas for fast connection up to 10 miles from the coast. The weBBoat® Link is a true compact Plug & Play device that requires minimal setup. You can use multiple mixed internet connection methods, allowing the combination of satellite, cellular, Wi-Fi or any fixed line services, if available, into a single onboard internet system. This allows a non-stop internet connection while cruising both closed to the coast and offshore. As the boat moves away from the marina weBBoat® Link loses the ability to connect to the marina WiFi but still has cellular and satellite connectivity capability.

Some of the weBBoat® Link main features are:

- ▶ Automatic APN: Easier and Faster configuration with the automatic selection of your SIM card carrier APN.
- ▶ Using the Glomex webUI or App you can manage and configure any aspect of your onboard internet connection system. You can also read/send SMS and check the SIM credit and the cellular internet data consumption.
- ▶ Priority function: to choose which connection type is used and in which assigned priority order. Typically, the highest priority links will be the cheaper high bandwidth connections (marina Wi-Fi, then Cellular) with the lowest priority link being the more expensive satellite internet connection. With weBBoat Link you can choose also to enable only one internet connection methods, for example the marina Wi-Fi to reduce the cellular or satellite internet data consumption and costs.
- ▶ Encrypted real-time peer-to-peer connection for remote set-up & service.

SIM CARD SLOT	SINGLE SIM
DC POWER SUPPLY	10/30 Vdc
AUTOMATIC SWITCH WI-FI REGISTERED NETWORKS TO 4G	
AUTOMATIC APN	
SMS MANAGEMENT FUNCTION	
V-SAT/SAT INTERNET AUTOSWITCH MODE	
SWITCHING CELLULAR DATA TO EXTERNAL WI-FI	
ENCRYPTED REAL-TIME PEER-TO-PEER CONNECTION FOR REMOTE SET-UP AND SERVICE	
4G BACKUP WAN FUNCTION	
LTE 4G UP TO 100 MBPS IN DOWNLOAD	
DC- HSPA+ UP TO 42 MBPS IN DOWNLOAD	
<i>More info on www.glomex.it</i>	

code: IT1304 (for Europe, Middle East, Africa and Asia)

 weBBoat® Link (code IT1304) est la nouvelle unité Single SIM 4G / Wi-Fi Coastal & Ocean à placer à l'intérieur du bateau pour surfer sur Internet et disposer d'un réseau Wi-Fi sécurisé à l'intérieur et à l'extérieur du bateau en utilisant les antennes 4G et Wi-Fi intégrées pour une connexion rapide jusqu'à 10 miles de la côte. De plus, le weBBoat® Link est un véritable appareil Plug & Play compact qui nécessite une configuration minimale. Avec le weBBoat® Link, il est possible d'utiliser plusieurs méthodes de connexion Internet, permettant la combinaison de l'internet par satellite, cellulaire et Wi-Fi ou de tout service fixe, si disponible, dans un seul système Internet embarqué. Cela permet une connexion Internet ininterrompue le long de la côte et en mer. Lorsque le bateau s'éloigne du port, weBBoat Link® perd la capacité de se connecter au port WiFi mais conserve le signal Internet via SIM et via les appareils Internet par satellite embarqués.

Parmi les caractéristiques les plus importantes du weBBoat® Link, nous avons:

- ▶ APN automatique: configuration plus simple et plus rapide de l'appareil avec sélection automatique de l'APN opérateur de la carte SIM insérée dans l'appareil.
- ▶ En utilisant l'interface utilisateur webUi ou l'application Glomex, il est possible de gérer et de configurer n'importe quel aspect du système de connexion Internet embarqué. Vous pouvez également lire / envoyer des SMS et vérifier votre crédit SIM et votre consommation de données Internet mobile.
- ▶ Fonction Priority: avec cette fonction, il est possible de choisir le type de connexion Internet à utiliser parmi celles possibles et dans quel ordre de priorité. En règle générale, les connexions Internet de priorité la plus élevée seront les connexions à large bande passant les moins chères (Wi-Fi de la marina et données Internet via SIM), tandis que les connexions de priorité la plus basse seront les connexions par satellite les plus chères. Avec weBBoat® Link, vous pouvez également choisir d'activer un seul mode de connexion Internet, par exemple le WI-FI de la marina pour réduire la consommation de données Internet depuis le mobile ou le satellite.
- ▶ Connexion peer-to-peer cryptée en temps réel pour la configuration et l'assistance technique à distance.

 weBBoat® Link (codice IT1304) è il nuovo sistema Single SIM 4G / Wi-Fi Coastal & Ocean da collocare all'interno dell'imbarcazione per navigare in internet e avere un hotspot Wi-Fi sicuro all'interno e all'esterno della barca fino a 10 miglia dalla costa. Con il weBBoat® Link è possibile utilizzare più metodi di connessione Internet, consentendo la combinazione di internet via satellite, via cellulare, e Wi-Fi o qualsiasi servizio di linea fissa, se disponibile, in un unico sistema Internet di bordo. Ciò consente una connessione Internet senza interruzioni sia lungo la costa che in mare aperto. Quando la barca si allontana dal porto, weBBoat® Link perde la capacità di connettersi al WiFi del porto ma mantiene il segnale internet via SIM e tramite i dispositivi internet satellitari di bordo.

Tra le caratteristiche più importanti del weBBoat® Link abbiamo:

- ▶ APN automatico: configurazione più semplice e veloce del dispositivo con la selezione automatica dell'APN dell'operatore della carta SIM inserita nell'unità.
- ▶ Utilizzando l'interfaccia utente webUi o l'App Glomex è possibile gestire e configurare qualsiasi aspetto del sistema di connessione Internet di bordo. È inoltre possibile leggere / inviare SMS e controllare il credito della SIM e il consumo di dati Internet mobile.
- ▶ Funzione Priority: con questa funzione è possibile scegliere quale tipo di connessione internet utilizzare tra quelle possibili e in quale ordine di priorità. Generalmente, le connessioni internet con priorità più alta saranno le connessioni più economiche a larghezza di banda elevata (Wi-Fi della marina, e dati internet via SIM), mentre le connessioni con la priorità più bassa saranno quelle più costose via satellite. Con weBBoat® Link EXT puoi anche scegliere di abilitare solo una modalità di connessione ad internet, ad esempio il WI-FI del porto turistico per ridurre il consumo dei dati internet da cellulare o satellite.
- ▶ Connessione peer-to-peer in tempo reale crittografata per la configurazione e l'assistenza tecnica da remoto.



🇺🇸 weBBoat® Link High Speed (code IT1304HS) is the new Single SIM 4G/Wi-Fi indoor unit Coastal & Ocean internet system to get internet on your boat and a secure Wi-Fi hotspot inside and outside the boat using the in-built 4G and Wi-Fi antennas for fast connection up to 10 miles from the coast.

weBBoat® Link High Speed is equipped with two 4G diversity antennas, two 2.4GHz MIMO Wi-Fi antennas, and a super-fast 4G/Wi-Fi router that creates a safe hotspot on the boat and motorhome. weBBoat® Link High Speed ensures high connection speed, up to 300Mbps in DL, that allows you to surf the web, make video calls, watch streaming platform along the coast. Moreover, it has a new double power processor and the carrier aggregation function for optimizing the speed of data transfers and taking advantage of all the potential offered by the net. Thanks to the weBBoat® Link systems, you can use up to 24 different devices simultaneously without any degradation to the signal or performance.

The weBBoat® Link is a true compact Plug & Play device that requires minimal setup. You can use multiple mixed internet connection methods, allowing the combination of satellite, cellular, Wi-Fi or any fixed line services, if available, into a single onboard internet system. This allows a non-stop internet connection while cruising both closed to the coast and offshore. As the boat moves away from the marina weBBoat® Link loses the ability to connect to the marina WiFi but still has cellular and satellite connectivity capability.

weBBoat Link High Speed

HIGH SPEED SINGLE SIM 4G/WI-FI ocean & coastal internet indoor unit to surf the web up to 10 miles from the coast

Category: Indoor unit

Subcategory: Single SIM / Small-medium fiberglass and metal boats / 10 miles

Code: IT1304HS



SIM CARD SLOT:	SINGLE SIM
LTE CAT6:	Up to 300Mbps in download
DC-HSPA+:	Max 42Mbps in download
WIRELESS MODE:	IEEE 802.11b/g/n
CPU:	650MHz (instead of 400MHz of standard weBBoat Link)
RAM:	128MB (instead of 64MB of standard weBBoat Link)
AUTOMATIC SWICHT WI-FI REGISTERED NETWORKS TO 4G.	
AUTOMATIC APN	
SMS MANAGEMENT FUNCTION	
V-SAT/SAT INTERNET AUTOSWITCH MODE	
SWITCHING CELLULAR DATA TO EXTERNAL WI-FI	
ENCRYPTED REAL-TIME PEER-TO-PEERCONNECTION FOR REMOTE SET-UP AND SERVICE	
4G BACKUP WAN FUNCTION	
POWER SUPPLY: 10/30 VDC	
COMPLIES WITH IEEE 802.11N, IEEE 802.11G AND IEEE 802.11B WIRELESS	
2 ETHERNET PORTS (1 WAN + 1 LAN)	
2 4G ANTENNAS	
2 WI-FI ANTENNA	
SMS REBOOT FUNCTION	
ANDROID AND IOS APP FOR AN EASY CONTROL	
WEBUI FOR ADVANCED SETTINGS	
EASY INSTALLATION REQUIRE ONLY POWER SUPPLY CONNECTION 12/24V	
IP56	
<i>More info on www.glomex.it</i>	

Some of the weBBoat® Link High Speed main features are:

- ▶ Automatic APN: Easier and Faster configuration with the automatic selection of your SIM card carrier APN.
- ▶ Using the Glomex webUI or App you can manage and configure any aspect of your onboard internet connection system. You can also read/send SMS and check the SIM credit and the cellular internet data consumption.
- ▶ Priority function: to choose which connection type is used and in which assigned priority order. Typically, the highest priority links will be the cheaper high bandwidth connections (marina Wi-Fi, then Cellular) with the lowest priority link being the more expensive satellite internet connection. With weBBoat Link you can choose also to enable only one internet connection methods, for example the marina Wi-Fi to reduce the cellular or satellite internet data consumption and costs.
- ▶ Encrypted real-time peer-to-peer connection for remote set-up & service.

code: IT1304HS (for Europe, Middle East, Africa, Asia, South America, Australia and New Zealand)

code: IT1304HS/US (for North America)

 weBBoat® Link High Speed (code IT1304HS) est le nouveau système Single SIM 4G / Wi-Fi Coastal & Ocean à placer à l'intérieur du bateau pour naviguer sur Internet et avoir un point d'accès Wi-Fi sécurisé à l'intérieur et à l'extérieur du bateau jusqu'à 10 miles de la côte. weBBoat® Link High Speed assure une grande vitesse de connexion, jusqu'à 300Mbps en DL, qui vous permet de naviguer sur le web, faire des appels vidéo, regarder la plate-forme de streaming le long de la côte. Il est également équipé d'un nouveau processeur à double puissance et de la fonction "carrier aggregation" pour optimiser la vitesse de transfert des données et exploiter tout le potentiel offert par Internet.

weBBoat® Link High Speed est équipé de deux antennes 4G Diversity, deux antennes Wi-Fi 2.4ghz MIMO, et un routeur 4G/Wifi qui reçoit le signal internet et le redirige à l'intérieur du bateau ou du camping-car avec un réseau Wifi sécurisé qui peut être utilisé simultanément par 24 appareils différents.

Avec le weBBoat® Link High Speed vous pouvez utiliser plusieurs méthodes de connexion Internet, permettant la combinaison d'Internet par satellite, par téléphone mobile, et Wi-Fi ou tout service de ligne fixe, si disponible, dans un seul système d'Internet à bord. Cela permet une connexion Internet sans interruption le long de la côte et en haute mer. Lorsque le bateau quitte le port, et que le signal Wi-Fi de la marina n'est plus disponible, weBBoat® Link High Speed maintient le signal Internet via SIM et via les appareils Internet satellite à bord.

Parmi les caractéristiques les plus importantes de la weBBoat® Link, nous avons:

- ▶ APN automatique : configuration plus simple et plus rapide du dispositif avec la sélection automatique de l'APN de l'opérateur de carte SIM insérée dans l'unité.
- ▶ En utilisant l'interface utilisateur webui ou l'application Glomex, vous pouvez gérer et configurer n'importe quel aspect du système de connexion Internet embarqué. Vous pouvez également lire / envoyer des SMS et vérifier le crédit de la carte SIM et la consommation de données Internet mobile.
- ▶ Fonction Priority : avec cette fonction, vous pouvez choisir quel type de connexion Internet utiliser parmi celles possibles et dans quel ordre de priorité. En général, les connexions Internet les plus prioritaires seront les connexions à bande passante élevée les moins chères (Wi-Fi de la Marina et données Internet via SIM), tandis que les connexions à priorité basse seront les plus coûteuses par satellite. Avec weBBoat® Link EXT, vous pouvez également choisir de n'activer qu'un seul mode de connexion à Internet, par exemple le Wi-Fi du port de plaisance pour réduire la consommation de données Internet par téléphone mobile ou satellite.
- ▶ Connexion peer-to-peer en temps réel cryptée pour la configuration et l'assistance technique à distance.

 weBBoat® Link High Speed (codice IT1304HS) è il nuovo sistema Single SIM 4G / Wi-Fi Coastal & Ocean da collocare all'interno dell'imbarcazione per navigare in internet e avere un hotspot Wi-Fi sicuro all'interno e all'esterno della barca fino a 10 miglia dalla costa.

weBBoat® Link High Speed assicura un'alta velocità di connessione, fino a 300Mbps in DL, che consente di navigare sul web, effettuare videochiamate, guardare la piattaforma di streaming lungo la costa. Inoltre è dotato di un nuovo processore a doppia potenza e della funzione di "carrier aggregation" per ottimizzare la velocità di trasferimento dei dati e sfruttare tutto il potenziale offerto da internet.

weBBoat® Link High Speed è dotato di due antenne 4G Diversity, due antenne Wi-Fi 2.4GHz MIMO, e un router 4G/WiFi che riceve il segnale internet e lo ridirige all'interno dell'imbarcazione o del camper con una rete WiFi protetta che può essere utilizzata contemporaneamente da 24 dispositivi differenti.

Con il weBBoat® Link High Speed è possibile utilizzare più metodi di connessione Internet, consentendo la combinazione di internet via satellite, via cellulare, e Wi-Fi o qualsiasi servizio di linea fissa, se disponibile, in un unico sistema Internet di bordo. Ciò consente una connessione Internet senza interruzioni sia lungo la costa che in mare aperto. Quando la barca si allontana dal porto, e il segnale Wi-Fi della marina non è più disponibile, weBBoat® Link High Speed mantiene il segnale internet via SIM e tramite i dispositivi internet satellitari di bordo.

Tra le caratteristiche più importanti del weBBoat® Link abbiamo:

- ▶ APN automatico: configurazione più semplice e veloce del dispositivo con la selezione automatica dell'APN dell'operatore della carta SIM inserita nell'unità.
- ▶ Utilizzando l'interfaccia utente webUi o l'App Glomex è possibile gestire e configurare qualsiasi aspetto del sistema di connessione Internet di bordo. È inoltre possibile leggere / inviare SMS e controllare il credito della SIM e il consumo di dati Internet mobile.
- ▶ Funzione Priority: con questa funzione è possibile scegliere quale tipo di connessione internet utilizzare tra quelle possibili e in quale ordine di priorità. Generalmente, le connessioni internet con priorità più alta saranno le connessioni più economiche a larghezza di banda elevata (Wi-Fi della marina, e dati internet via SIM), mentre le connessioni con la priorità più bassa saranno quelle più costose via satellite. Con weBBoat® Link EXT puoi anche scegliere di abilitare solo una modalità di connessione ad internet, ad esempio il Wi-Fi del porto turistico per ridurre il consumo dei dati internet da cellulare o satellite.
- ▶ Connessione peer-to-peer in tempo reale crittografata per la configurazione e l'assistenza tecnica da remoto



weBBoat Link High Speed EXT

HIGH SPEED SINGLE SIM 4G/WI-FI ocean & coastal internet extended range kit to surf the web up to 20 miles from the coast

Category: Indoor unit + external antennas

Subcategory: Single SIM / Small-medium-big fiberglass and metal boats / 20 miles

Code: IT1304HSEXT



weBBoat® Link EXT High Speed (code IT1304HSEXT) is the new Single SIM 4G/Wi-Fi indoor unit Coastal & Ocean internet system kit with indoor unit + 2 x high gain external 4G antennas and 2 x 7m (23') LMR200 coax cables to get internet on your boat and a secure Wi-Fi hotspot inside and outside the boat up to 20 miles from the coast.

weBBoat® Link EXT High Speed is equipped with two 4G diversity antennas, two 2.4GHz MIMO Wi-Fi antennas, and a super-fast 4G/Wi-Fi router that creates a safe hotspot on the boat and motorhome. weBBoat® Link High Speed ensures high connection speed, up to 300Mbps in DL, that allows you to surf the web, make video calls, watch streaming platform along the coast. Moreover, it has a new double power processor and the carrier aggregation function for optimizing the speed of data transfers and taking advantage of all the potential offered by the net. Thanks to the weBBoat® Link High Speed systems,

- ▶ you can use up to 24 different devices simultaneously without any degradation to the signal or performance.

The weBBoat® Link EXT High Speed is a true compact Plug & Play device that requires minimal setup. You can use multiple mixed internet connection methods, allowing the combination of satellite, cellular, Wi-Fi or any fixed line services, if available, into a single onboard internet system. This allows a non-stop internet connection while cruising both closed to the coast and offshore. As the boat moves away from the marina weBBoat® Link EXT High Speed loses the ability to connect to the marina WiFi but still has cellular and satellite connectivity capability.

- ▶

SIM CARD SLOT:	SINGLE SIM
LTE CAT6:	Up to 300Mbps in download
DC-HSPA+:	Max 42Mbps in download
WIRELESS MODE:	IEEE 802.11b/g/n
CPU:	650MHz (instead of 400MHz of standard weBBoat Link)
RAM:	128MB (instead of 64MB of standard weBBoat Link)
AUTOMATIC SWITCH WI-FI REGISTERED NETWORKS TO 4G.	
AUTOMATIC APN	
SMS MANAGEMENT FUNCTION	
V-SAT/SAT INTERNET AUTOSWITCH MODE	
SWITCHING CELLULAR DATA TO EXTERNAL WI-FI	
ENCRYPTED REAL-TIME PEER-TO-PEER CONNECTION FOR REMOTE SET-UP AND SERVICE	
4G BACKUP WAN FUNCTION	
POWER SUPPLY: 10/30 VDC	
COMPLIES WITH IEEE 802.11N, IEEE 802.11G AND IEEE 802.11B WIRELESS	
2 ETHERNET PORTS (1 WAN + 1 LAN)	
2 EXTERNAL 4G ANTENNAS	
2 WI-FI ANTENNA	
SMS REBOOT FUNCTION	
ANDROID AND IOS APP FOR AN EASY CONTROL	
WEBUI FOR ADVANCED SETTINGS	
EASY INSTALLATION REQUIRE ONLY POWER SUPPLY CONNECTION 12/24V	
IP56	
<i>More info on www.glomex.it</i>	

Some of the weBBoat® Link High Speed main features are:

- ▶ Automatic APN: Easier and Faster configuration with the automatic selection of your SIM card carrier APN.
- ▶ Using the Glomex webUI or App you can manage and configure any aspect of your onboard internet connection system. You can also read/send SMS and check the SIM credit and the cellular internet data consumption.
- ▶ Priority function: to choose which connection type is used and in which assigned priority order. Typically, the highest priority links will be the cheaper high bandwidth connections (marina Wi-Fi, then Cellular) with the lowest priority link being the more expensive satellite internet connection. With weBBoat Link you can choose also to enable only one internet connection methods, for example the marina Wi-Fi to reduce the cellular or satellite internet data consumption and costs.
- ▶ Encrypted real-time peer-to-peer connection for remote set-up & service.

code: IT1304EXTHS (for Europe, Middle East, Africa, Asia, South America, Australia and New Zealand)

code: IT1304EXTHS/US (for North America)

weBBoat® Link EXT High Speed (code IT1304HSEXT) est le nouveau kit Single SIM 4G / Wi-Fi Coastal & Ocean avec unités à placer à l'intérieur du bateau + 2 antennes 4G externes à haut gain et 2 câbles coaxiaux LMR200 de 7m pour surfer sur Internet et avoir un hotspot Wi-Fi sécurisé à l'intérieur et à l'extérieur du bateau jusqu'à 20 miles de la côte. est le nouveau système Single SIM 4G / Wi-Fi Coastal & Ocean à placer à l'intérieur du bateau pour naviguer sur Internet et avoir un point d'accès Wi-Fi sécurisé à l'intérieur et à l'extérieur du bateau jusqu'à 10 miles de la côte.

weBBoat® Link EXT High Speed assure une grande vitesse de connexion, jusqu'à 300Mbps en DL, qui vous permet de naviguer sur le web, faire des appels vidéo, regarder la plateforme de streaming le long de la côte. Il est également équipé d'un nouveau processeur à double puissance et de la fonction "carrier aggregation" pour optimiser la vitesse de transfert des données et exploiter tout le potentiel offert par Internet. weBBoat® Link EXT High Speed est équipé de deux antennes 4G Diversity, deux antennes Wi-Fi 2.4ghz MIMO, et un routeur 4G/Wifi qui reçoit le signal internet et le redirige à l'intérieur du bateau ou du camping-car avec un réseau Wifi sécurisé qui peut être utilisé simultanément par 24 appareils différents.

Avec le weBBoat® Link EXT High Speed vous pouvez utiliser plusieurs méthodes de connexion Internet, permettant la combinaison d'Internet par satellite, par téléphone mobile, et Wi-Fi ou tout service de ligne fixe, si disponible, dans un seul système d'Internet à bord. Cela permet une connexion Internet sans interruption le long de la côte et en haute mer. Lorsque le bateau quitte le port, et que le signal Wi-Fi de la marina n'est plus disponible, weBBoat® Link High Speed maintient le signal Internet via SIM et via les appareils Internet satellite à bord.

Parmi les caractéristiques les plus importantes de la weBBoat® Link, nous avons:

- ▶ APN automatique : configuration plus simple et plus rapide du dispositif avec la sélection automatique de l'APN de l'opérateur de carte SIM insérée dans l'unité.
- ▶ En utilisant l'interface utilisateur webui ou l'application Glomex, vous pouvez gérer et configurer n'importe quel aspect du système de connexion Internet embarqué. Vous pouvez également lire / envoyer des SMS et vérifier le crédit de la carte SIM et la consommation de données Internet mobile.
- ▶ Fonction Priority : avec cette fonction, vous pouvez choisir quel type de connexion Internet utiliser parmi celles possibles et dans quel ordre de priorité. En général, les connexions Internet les plus prioritaires seront les connexions à bande passante élevée les moins chères (Wi-Fi de la Marina et données Internet via SIM), tandis que les connexions à priorité basse seront les plus coûteuses par satellite. Avec weBBoat® Link EXT, vous pouvez également choisir de n'activer qu'un seul mode de connexion à Internet, par exemple le Wi-Fi du port de plaisance pour réduire la consommation de données Internet par téléphone mobile ou satellite.
- ▶ Connexion peer-to-peer en temps réel cryptée pour la configuration et l'assistance technique à distance.

SUPPLIED ACCESSORIES



▲ Indoor unit



▲ 2 x high gain external 4G antennas



▲ 2 x 7m (23') LMR200 pre-wired coax cables

weBBoat® Link EXT High Speed (codice IT1304HSEXT) è il nuovo kit Single SIM 4G / Wi-Fi Coastal & Ocean con unità da collocare all'interno dell'imbarcazione + 2 antenne 4G esterne ad alto guadagno e 2 cavi coassiali LMR200 da 7m per navigare in internet e avere un hotspot Wi-Fi sicuro all'interno e all'esterno della barca fino a 20 miglia dalla costa. è il nuovo sistema Single SIM 4G / Wi-Fi Coastal & Ocean da collocare all'interno dell'imbarcazione per navigare in internet e avere un hotspot Wi-Fi sicuro all'interno e all'esterno della barca fino a 10 miglia dalla costa.

weBBoat® Link EXT High Speed assicura un'alta velocità di connessione, fino a 300Mbps in DL, che consente di navigare sul web, effettuare videochiamate, guardare la piattaforma di streaming lungo la costa. Inoltre è dotato di un nuovo processore a doppia potenza e della funzione di "carrier aggregation" per ottimizzare la velocità di trasferimento dei dati e sfruttare tutto il potenziale offerto da internet.

weBBoat® Link EXT High Speed è dotato di due antenne 4G Diversity, due antenne Wi-Fi 2.4GHz MIMO, e un router 4G/WiFi che riceve il segnale internet e lo ridireziona all'interno dell'imbarcazione o del camper con una rete WiFi protetta che può essere utilizzata contemporaneamente da 24 dispositivi differenti.

Con il weBBoat® Link EXT High Speed è possibile utilizzare più metodi di connessione Internet, consentendo la combinazione di internet via satellite, via cellulare, e Wi-Fi o qualsiasi servizio di linea fissa, se disponibile, in un unico sistema Internet di bordo. Ciò consente una connessione Internet senza interruzioni sia lungo la costa che in mare aperto. Quando la barca si allontana dal porto, e il segnale Wi-Fi della marina non è più disponibile, weBBoat® Link High Speed mantiene il segnale internet via SIM e tramite i dispositivi internet satellitari di bordo.

Tra le caratteristiche più importanti del weBBoat® Link abbiamo:

- ▶ APN automatico: configurazione più semplice e veloce del dispositivo con la selezione automatica dell'APN dell'operatore della carta SIM inserita nell'unità.
- ▶ Utilizzando l'interfaccia utente webUi o l'App Glomex è possibile gestire e configurare qualsiasi aspetto del sistema di connessione Internet di bordo. È inoltre possibile leggere / inviare SMS e controllare il credito della SIM e il consumo di dati Internet mobile.
- ▶ Funzione Priority: con questa funzione è possibile scegliere quale tipo di connessione internet utilizzare tra quelle possibili e in quale ordine di priorità. Generalmente, le connessioni internet con priorità più alta saranno le connessioni più economiche a larghezza di banda elevata (Wi-Fi della marina, e dati internet via SIM), mentre le connessioni con la priorità più bassa saranno quelle più costose via satellite. Con weBBoat® Link EXT puoi anche scegliere di abilitare solo una modalità di connessione ad internet, ad esempio il Wi-Fi del porto turistico per ridurre il consumo dei dati internet da cellulare o satellite.
- ▶ Connessione peer-to-peer in tempo reale crittografata per la configurazione e l'assistenza tecnica da remoto

OPTIONAL ACCESSORIES



▲ PRM180 Electropolished AISI316 stainless steel deck mount, 1" BSP thread



weBBoat Link PRO 5G

DUAL SIM 5G/WI-FI ocean & coastal internet indoor unit to surf the web up to 15 miles from the coast

Category: Indoor unit

Subcategory: Dual SIM / 15 miles

Code: IT1405PRO



 weBBoat® Link PRO 5G (code IT1405PRO) is the new Worldwide* Dual SIM 5G/Wi-Fi indoor unit Coastal & Ocean internet system to get internet on your boat and a secure Wi-Fi hotspot inside and outside the boat using the in-built 4G and Wi-Fi antennas for fast connection up to 15 miles from the coast. The weBBoat® Link PRO 5G is a true compact Plug & Play device that requires minimal setup. Now, you have an ultra-fast connection download speed on board: up to 2.5 Gbps. Moreover, if you sail in an area with no 5G signal coverage, the LTE CAT 16 unit allows you to have a 4G connection speed up to 1Gbps. 5G offers a connection with the same level of fibre, but totally wireless and therefore perfect to be used on board. There are 4 x high performance 5G and 2 x 2.4/5GHz MIMO Wi-Fi antennas for optimizing the speed of data transfers with a huge increase on the connection speed. That means that you can either watch streaming TV channels and platforms such as Netflix offshore, or work remotely on your boat, using internet connection as like you would be on the mainland.

Equipped with the new revolutionary Glomex MIoT Routerboard platform with a super-powerful processor, that highly increases the connection speed compared to other existing internet systems. Up to 32 different devices can be used simultaneously without any degradation to the signal or performance. The units built-in advanced switching software allows the user to save money on costly roaming and overage charges by automatically switching to Wi-Fi when available. You can use multiple mixed internet connection methods, allowing the combination of satellite, cellular, Wi-Fi or any fixed line services, if available, into a single onboard internet system. This allows a non-stop internet connection while cruising both closed to the coast and offshore. As the boat moves away from the marina weBBoat® Link PRO 5G loses the ability to connect to the marina WiFi but still has cellular and satellite connectivity capability.

Some of the weBBoat® Link PRO 5G main features are:

- ▶ Carrier aggregation. The new weBBoat Plus 5G takes advantage of the flexible bandwidth option

SIM CARD SLOT:	DUAL SIM
WORLDWIDE UNIT:	for Europe, Middle East, North and South Americas, Australia, New Zealand, Africa and Asia (except for China)
INTERNET ANTENNAS:	4 x 5G + 2 x 2.4/5GHz MIMO Wi-Fi antennas
5G:	Up to 2.5Gbps in download
LTE CAT16:	Up to 1Gbps in download
WCDMA:	Max 42Mbps in download
CPU:	Arm Cortex-A7 800MHz
RAM:	256MB DDR3
POWER SUPPLY:	10/30 Vdc
AVERAGE CONSUMPTION:	150mA
AUTOMATIC SWITCH WI-FI REGISTERED NETWORKS TO 5G/4G.	
AUTOMATIC APN	
SMS MANAGEMENT FUNCTION	
V-SAT/SAT INTERNET AUTOSWITCH MODE	
SWITCHING CELLULAR DATA TO EXTERNAL WI-FI	
ENCRYPTED REAL-TIME PEER-TO-PEER CONNECTION FOR REMOTE SET-UP AND SERVICE	
COMPLIES WITH IEEE 802.11N, IEEE 802.11G AND IEEE 802.11B WIRELESS	
2 ETHERNET PORTS (1 WAN + 1 LAN)	
SMS REBOOT FUNCTION	
ANDROID AND IOS APP FOR AN EASY CONTROL	
WEBUI FOR ADVANCED SETTINGS	
EASY INSTALLATION REQUIRE ONLY POWER SUPPLY CONNECTION 12/24V IP56	
<i>More info on www.glomex.it</i>	

in LTE and adds the capability to combine multiple bands of the carrier into one big channel. It can access a much bigger data pipe and therefore the achievable data rates improve significantly. Carrier aggregation is supported by improvements to the unit technologies, to make the overall spectrum usage more efficient

- ▶ Automatic APN: Easier and Faster configuration with the automatic selection of your SIM card carrier APN.
- ▶ Using the Glomex webUI or App you can manage and configure any aspect of your onboard internet connection system. You can also read/send SMS and check the SIM credit and the cellular internet data consumption.
- ▶ Priority function: to choose which connection type is used and in which assigned priority order. Typically, the highest priority links will be the cheaper high bandwidth connections (marina Wi-Fi, then Cellular) with the lowest priority link being the more expensive satellite internet connection. With weBBoat® Link PRO you can choose also to enable only one internet connection methods, for example the marina WI-FI to reduce the cellular or satellite internet data consumption and costs.
- ▶ Encrypted real-time peer-to-peer connection for remote set-up & service.



 weBBoat® Link PRO 5G (code IT1405PRO) est la nouvelle unité, fonctionnant dans le monde entier à l'exception de la Chine, Dual SIM 5G/Wi-Fi Coastal & Ocean à placer à l'intérieur du bateau pour naviguer sur Internet et avoir un réseau Wi-Fi sécurisé à l'intérieur et à l'extérieur du bateau en utilisant les antennes intégrées 5G et Wi-Fi pour une connexion rapide jusqu'à 15 miles de la côte. weBBoat® Link PRO 5G est équipé de 4 antennes 5G qui reçoivent le signal internet et le redirigent à l'intérieur du bateau en fibre de verre avec un réseau Wifi sécurisé qui peut être utilisé simultanément par 32 appareils différents et autorisés. Grâce à weBBoat® Link PRO 5G vous avez une vitesse de téléchargement de connexion ultra-rapide à bord : jusqu'à 2,5 Gbps. De plus, si vous naviguez dans une zone sans couverture 5G, l'unité LTE CAT 16 permet d'avoir une vitesse de connexion 4G jusqu'à 1gbps. La 5G offre une connexion avec le même niveau de fibre, mais totalement sans fil et donc parfait pour être utilisé à bord.

Il y a 4 antennes 5G hautes performances et 2 x 2.4/5ghz MIMO Wi-Fi pour optimiser la vitesse de transfert de données avec une énorme augmentation de la vitesse de connexion. Cela signifie que vous pouvez regarder des chaînes de télévision en streaming et des plates-formes comme Netflix offshore, ou de travailler à distance sur votre bateau, en utilisant la connexion Internet comme vous le feriez sur le continent.

Avec le weBBoat Link PRO, vous pouvez utiliser plusieurs méthodes de connexion Internet, permettant la combinaison d'Internet par satellite, téléphone mobile, et Wi-Fi ou tout service de ligne fixe, si disponible, dans un seul système d'Internet à bord. Cela permet une connexion Internet sans interruption le long de la côte et en haute mer. Lorsque le bateau quitte le port, weBBoat® Link PRO perd la capacité de se connecter au Wifi du port mais maintient le signal Internet via SIM et via les appareils Internet satellite embarqués.

Parmi les caractéristiques les plus importantes de la weBBoat® Liens PRO EXT 5G nous avons:

- ▶ Fonction "carrier aggregation" pour optimiser la vitesse de transfert des données et exploiter tout le potentiel offert par l'internet
- ▶ APN automatique : configuration plus simple et plus rapide du dispositif avec la sélection automatique de l'APN de l'opérateur de carte SIM insérée dans l'unité.
- ▶ En utilisant l'interface utilisateur webui ou l'application Glomex, vous pouvez gérer et configurer n'importe quel aspect du système de connexion Internet embarqué. Vous pouvez également lire / envoyer des SMS et vérifier le crédit de la carte SIM et la consommation de données Internet mobile.
- ▶ Fonction Priority : avec cette fonction, vous pouvez choisir quel type de connexion Internet utiliser parmi celles possibles et dans quel ordre de priorité. En général, les connexions Internet les plus prioritaires seront les connexions à bande passante élevée les moins chères (Wi-Fi de la Marine et données Internet via SIM), tandis que les connexions à priorité basse seront les plus coûteuses par satellite. Avec weBBoat® Link PRO, vous pouvez également choisir de n'activer qu'un seul mode de connexion à Internet, par exemple le WI-FI du port de plaisance pour réduire la consommation de données Internet par téléphone mobile ou satellite.
- ▶ Connexion peer-to-peer en temps réel cryptée pour la configuration et l'assistance technique à distance.

 weBBoat® Link PRO 5G (codice IT1405PRO) è la nuova unità, funzionante in tutto il mondo ad eccezione della Cina, Dual SIM 5G/Wi-Fi Coastal & Ocean da collocare all'interno dell'imbarcazione per navigare in internet e avere una rete Wi-Fi sicura all'interno e all'esterno dell'imbarcazione utilizzando le antenne integrate 5G e Wi-Fi per una connessione veloce fino a 15 miglia dalla costa. weBBoat® Link PRO 5G è dotato di 4 antenne 5G che ricevono il segnale internet e lo ridirezionano all'interno dell'imbarcazione in vetroresina con una rete WiFi sicura e protetta che può essere utilizzata contemporaneamente da 32 dispositivi differenti e autorizzati. Grazie a weBBoat® Link PRO 5G si dispone di una velocità di download di connessione ultra-veloce a bordo: fino a 2,5 Gbps. Inoltre, se navighi in un'area senza copertura 5G, l'unità LTE CAT 16 permette di avere una velocità di connessione 4G fino a 1Gbps. Il 5G offre una connessione con lo stesso livello di fibra, ma totalmente wireless e quindi perfetto per essere utilizzato a bordo.

Sono presenti 4 antenne 5G ad alte prestazioni e 2 x 2.4/5GHz MIMO Wi-Fi per ottimizzare la velocità di trasferimento dei dati con un enorme aumento della velocità di connessione. Ciò significa che è possibile guardare i canali TV in streaming e piattaforme come Netflix offshore, o lavorare in remoto sulla vostra barca, utilizzando la connessione internet come si farebbe sulla terraferma.

Con il weBBoat Link PRO è possibile utilizzare più metodi di connessione Internet, consentendo la combinazione di internet via satellite, via cellulare, e Wi-Fi o qualsiasi servizio di linea fissa, se disponibile, in un unico sistema Internet di bordo. Ciò consente una connessione Internet senza interruzioni sia lungo la costa che in mare aperto. Quando la barca si allontana dal porto, weBBoat® Link PRO perde la capacità di connettersi al WiFi del porto ma mantiene il segnale internet via SIM e tramite i dispositivi internet satellitari di bordo.

Tra le caratteristiche più importanti del weBBoat® Link PRO 5G abbiamo:

- ▶ funzione di "carrier aggregation" per ottimizzare la velocità di trasferimento dei dati e sfruttare tutto il potenziale offerto da internet
- ▶ APN automatico: configurazione più semplice e veloce del dispositivo con la selezione automatica dell'APN dell'operatore della carta SIM inserita nell'unità.
- ▶ Utilizzando l'interfaccia utente webUi o l'App Glomex è possibile gestire e configurare qualsiasi aspetto del sistema di connessione Internet di bordo. È inoltre possibile leggere / inviare SMS e controllare il credito della SIM e il consumo di dati Internet mobile.
- ▶ Funzione Priority: con questa funzione è possibile scegliere quale tipo di connessione internet utilizzare tra quelle possibili e in quale ordine di priorità. Generalmente, le connessioni internet con priorità più alta saranno le connessioni più economiche a larghezza di banda elevata (Wi-Fi della marina, e dati internet via SIM), mentre le connessioni con la priorità più bassa saranno quelle più costose via satellite. Con weBBoat® Link PRO puoi anche scegliere di abilitare solo una modalità di connessione ad internet, ad esempio il WI-FI del porto turistico per ridurre il consumo dei dati internet da cellulare o satellite.
- ▶ Connessione peer-to-peer in tempo reale crittografata per la configurazione e l'assistenza tecnica da remoto.

NEW



 **weBBoat® Link PRO EXT** (code IT1405PROEXT) is the new worldwide Dual SIM 5G/Wi-Fi indoor unit Coastal & Ocean internet system kit with indoor unit + 4 x high gain external 4G antennas and to get internet on your boat and a secure Wi-Fi hotspot inside and outside the boat up to 25 miles from the coast.

Now, you have an ultra-fast connection download speed on board: up to 2.5 Gbps. Moreover, if you sail in an area with no 5G signal coverage, the LTE CAT 16 unit allows you to have a 4G connection speed up to 1Gbps. 5G offers a connection with the same level of fibre, but totally wireless and therefore perfect to be used on board.

There are 4 x high performance 5G and 2 x 2.4/5GHz MIMO Wi-Fi antennas for optimizing the speed of data transfers with a huge increase on the connection speed. That means that you can either watch streaming TV channels and platforms such as Netflix offshore, or work remotely on your boat, using internet connection as like you would be on the mainland.

Equipped with the new revolutionary Glomex MIoT Routerboard platform with a super-powerful processor, that highly increases the connection speed compared to other existing internet systems.

Up to 32 different devices can be used simultaneously without any degradation to the signal or performance. The units built-in advanced switching software allows the user to save money on costly roaming and overage charges by automatically switching to Wi-Fi when available.

You can use multiple mixed internet connection methods, allowing the combination of satellite, cellular, Wi-Fi or any fixed line services, if available, into a single onboard internet system. This allows a non-stop internet connection while cruising both closed to the coast and offshore. As the boat moves away from the marina weBBoat Link PRO EXT loses the ability to connect to the marina WiFi but still has cellular and satellite connectivity capability.

Some of the weBBoat® Link PRO EXT main features are:

- ▶ Carrier aggregation. The new weBBoat Plus 5G takes advantage of the flexible bandwidth option in LTE and adds the capability to combine multiple bands of the

weBBoat Link PRO 5G EXT

DUAL SIM 5G/WI-FI ocean & coastal internet extended range kit to surf the web up to 25 miles from the coast

Category: Indoor unit + external antennas

Subcategory: Dual SIM / Small-medium-big fiberglass and metal boats / 25 miles

Code: IT1405PROEXT



SIM CARD SLOT:	DUAL SIM
WORLDWIDE UNIT:	for Europe, Middle East, North and South Americas, Australia, New Zealand, Africa and Asia (except for China)
INTERNET ANTENNAS:	External 5G antenna + 2 x 2.4/5GHz MIMO Wi-Fi antennas
5G:	Up to 2.5Gbps in download
LTE CAT 16:	Up to 1Gbps in download
WCDMA:	Max 42Mbps in download
CPU:	Arm Cortex-A7 800MHZ
RAM:	256MB DDR3
POWER SUPPLY:	10/30 Vdc
AVERAGE CONSUMPTION:	150mA
AUTOMATIC SWICHT WI-FI REGISTERED NETWORKS TO 4G.	
AUTOMATIC APN	
SMS MANAGEMENT FUNCTION	
V-SAT/SAT INTERNET AUTOSWITCH MODE	
SWITCHING CELLULAR DATA TO EXTERNAL WI-FI	
ENCRYPTED REAL-TIME PEER-TO-PEER CONNECTION FOR REMOTE SET-UP AND SERVICE	
COMPLIES WITH IEEE 802.11N, IEEE 802.11G AND IEEE 802.11B WIRELESS	
4 ETHERNET PORTS (1 WAN + 3 LAN)	
SMS REBOOT FUNCTION	
ANDROID AND IOS APP FOR AN EASY CONTROL	
WEBUI FOR ADVANCED SETTINGS	
EASY INSTALLATION REQUIRE ONLY POWER SUPPLY CONNECTION 12/24V	
IP56	
<i>More info on www.glomex.it</i>	

carrier into one big channel. It can access a much bigger data pipe and therefore the achievable data rates improve significantly. Carrier aggregation is supported by improvements to the unit technologies, to make the overall spectrum usage more efficient

- ▶ Automatic APN: Easier and Faster configuration with the automatic selection of your SIM card carrier APN.
- ▶ Using the Glomex webUI or App you can manage and configure any aspect of your onboard internet connection system. You can also read/send SMS and check the SIM credit and the cellular internet data consumption.
- ▶ Priority function: to choose which connection type is used and in which assigned priority order. Typically, the highest priority links will be the cheaper high bandwidth connections (marina Wi-Fi, then Cellular) with the lowest priority link being the more expensive satellite internet connection. With weBBoat® Link PRO EXT you can choose also to enable only one internet connection methods, for example the marina WI-FI to reduce the cellular or satellite internet data consumption and costs.
- ▶ Encrypted real-time peer-to-peer connection for remote set-up & service.



weBBoat® Link PRO EXT (code IT1405PROEXT) est le nouveau kit Single SIM 5G / Wi-Fi Coastal & Ocean, fonctionnant dans le monde entier*, avec unité à placer à l'intérieur du bateau + 4 antennes 5G externes à haut gain pour naviguer sur Internet et avoir un point d'accès Wi-Fi sécurisé à l'intérieur et à l'extérieur du bateau jusqu'à 25 miles de la côte.

weBBoat® Link PRO 5G est équipé de 4 antennes 5G qui reçoivent le signal internet et le redirigent à l'intérieur du bateau en fibre de verre avec un réseau Wifi sécurisé qui peut être utilisé simultanément par 32 appareils différents et autorisés. Grâce à weBBoat® Link PRO 5G vous avez une vitesse de téléchargement de connexion ultra-rapide à bord : jusqu'à 2,5 Gbps. De plus, si vous naviguez dans une zone sans couverture 5G, l'unité LTE CAT 16 permet d'avoir une vitesse de connexion 4G jusqu'à 1gbps. La 5G offre une connexion avec le même niveau de fibre, mais totalement sans fil et donc parfait pour être utilisé à bord. Il y a 4 antennes 5G hautes performances et 2 x 2.4/5ghz MIMO Wi-Fi pour optimiser la vitesse de transfert de données avec une énorme augmentation de la vitesse de connexion. Cela signifie que vous pouvez regarder des chaînes de télévision en streaming et des plates-formes comme Netflix offshore, ou de travailler à distance sur votre bateau, en utilisant la connexion Internet comme vous le feriez sur le continent. Avec le weBBoat Link PRO, vous pouvez utiliser plusieurs méthodes de connexion Internet, permettant la combinaison d'Internet par satellite, téléphone mobile, et Wi-Fi ou tout service de ligne fixe, si disponible, dans un seul système d'Internet à bord. Cela permet une connexion Internet sans interruption le long de la côte et en haute mer. Lorsque le bateau quitte le port, weBBoat® Link PRO perd la capacité de se connecter au Wifi du port mais maintient le signal Internet via SIM et via les appareils Internet satellite embarqués.

Parmi les caractéristiques les plus importantes de la weBBoat® Liens PRO EXT 5G nous avons:

Fonction "carrier aggregation" pour optimiser la vitesse de transfert des données et exploiter tout le potentiel offert par l'internet

▶ APN automatique : configuration plus simple et plus rapide du dispositif avec la sélection automatique de l'APN de l'opérateur de carte SIM insérée dans l'unité.

▶ En utilisant l'interface utilisateur webui ou l'application Glomex, vous pouvez gérer et configurer n'importe quel aspect du système de connexion Internet embarqué. Vous pouvez également lire / envoyer des SMS et vérifier le crédit de la carte SIM et la consommation de données Internet mobile.

▶ Fonction Priority : avec cette fonction, vous pouvez choisir quel type de connexion Internet utiliser parmi celles possibles et dans quel ordre de priorité. En général, les connexions Internet les plus prioritaires seront les connexions à bande passante élevée les moins chères (Wi-Fi de la Marine et données Internet via SIM), tandis que les connexions à priorité basse seront les plus coûteuses par satellite. Avec weBBoat® Link PRO, vous pouvez également choisir de n'activer qu'un seul mode de connexion à Internet, par exemple le WI-FI du port de plaisance pour réduire la consommation de données Internet par téléphone mobile ou satellite.

▶ Connexion peer-to-peer en temps réel cryptée pour la configuration et l'assistance technique à distance.

weBBoat® Link PRO EXT (codice IT1405PROEXT) è il nuovo kit Single SIM 5G / Wi-Fi Coastal & Ocean, funzionante in tutto il mondo*, con unità da collocare all'interno dell'imbarcazione + 4 antenne 5G esterne ad alto guadagno per navigare in internet e avere un hotspot Wi-Fi sicuro all'interno e all'esterno della barca fino a 25 miglia dalla costa.

weBBoat® Link PRO 5G è dotato di 4 antenne 5G che ricevono il segnale internet e lo ridirezionano all'interno dell'imbarcazione in vetroresina con una rete WiFi sicura e protetta che può essere utilizzata contemporaneamente da 32 dispositivi differenti e autorizzati. Grazie a weBBoat® Link PRO 5G si dispone di una velocità di download di connessione ultra-veloce a bordo: fino a 2,5 Gbps. Inoltre, se navighi in un'area senza copertura 5G, l'unità LTE CAT 16 permette di avere una velocità di connessione 4G fino a 1Gbps. Il 5G offre una connessione con lo stesso livello di fibra, ma totalmente wireless e quindi perfetto per essere utilizzato a bordo.

Sono presenti 4 antenne 5G ad alte prestazioni e 2 x 2.4/5GHz MIMO Wi-Fi per ottimizzare la velocità di trasferimento dei dati con un enorme aumento della velocità di connessione. Ciò significa che è possibile guardare i canali TV in streaming e piattaforme come Netflix offshore, o lavorare in remoto sulla vostra barca, utilizzando la connessione internet come si farebbe sulla terraferma.

Con il weBBoat Link PRO è possibile utilizzare più metodi di connessione Internet, consentendo la combinazione di internet via satellite, via cellulare, e Wi-Fi o qualsiasi servizio di linea fissa, se disponibile, in un unico sistema Internet di bordo. Ciò consente una connessione Internet senza interruzioni sia lungo la costa che in mare aperto. Quando la barca si allontana dal porto, weBBoat® Link PRO perde la capacità di connettersi al WiFi del porto ma mantiene il segnale internet via SIM e tramite i dispositivi internet satellitari di bordo.

Tra le caratteristiche più importanti del weBBoat® Link PRO EXT 5G abbiamo:

▶ funzione di "carrier aggregation" per ottimizzare la velocità di trasferimento dei dati e sfruttare tutto il potenziale offerto da internet

▶ APN automatico: configurazione più semplice e veloce del dispositivo con la selezione automatica dell'APN dell'operatore della carta SIM inserita nell'unità.

▶ Utilizzando l'interfaccia utente webUi o l'App Glomex è possibile gestire e configurare qualsiasi aspetto del sistema di connessione Internet di bordo. È inoltre possibile leggere / inviare SMS e controllare il credito della SIM e il consumo di dati Internet mobile.

▶ Funzione Priority: con questa funzione è possibile scegliere quale tipo di connessione internet utilizzare tra quelle possibili e in quale ordine di priorità. Generalmente, le connessioni internet con priorità più alta saranno le connessioni più economiche a larghezza di banda elevata (Wi-Fi della marina, e dati internet via SIM), mentre le connessioni con la priorità più bassa saranno quelle più costose via satellite. Con weBBoat® Link PRO puoi anche scegliere di abilitare solo una modalità di connessione ad internet, ad esempio il WI-FI del porto turistico per ridurre il consumo dei dati internet da cellulare o satellite.

▶ Connessione peer-to-peer in tempo reale crittografata per la configurazione e l'assistenza tecnica da remoto.

SUPPLIED ACCESSORIES OPTIONAL ACCESSORIES



▶ Indoor unit



▶ high gain external 5G antenna



▶ 2 x 7m (23') LMR200 pre-wired coax cables
▶ 2 x 10m (33') LMR200 pre-wired coax cables
▶ 2 x 20m (66') LMR200 pre-wired coax cables



▶ V9177

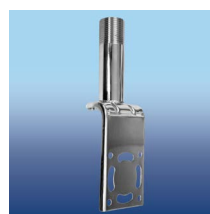

▶ V9176



▶ ITM001 nylon mount for cross tree

ITAP001

Additional access point for metal/large boat.

Category: Accessories

Subcategory: Access points

Code: ITAP001



- 150Mbps Wireless N Nano Router Access point, powered through a micro USB port by an external power adapter or USB connection to a computer. It is designed for use with tablets, smart phones, handheld game consoles and other portable electronic wireless devices.
- 150Mbps Wireless N Nano Router Point d'accès, alimenté par un port micro USB par un adaptateur d'alimentation externe ou une connexion USB à un ordinateur. Il est conçu pour être utilisé avec des tablettes, des téléphones intelligents, des consoles de jeux portables et d'autres appareils sans fil électroniques portatifs.
- 150Mbps Wireless N Nano Router, alimentato tramite una porta micro USB da un alimentatore o tramite collegamento USB ad un computer. È stato progettato per l'utilizzo con tablet, smartphone, console di gioco portatili e altri dispositivi wireless elettronici portatili.

OPTIONAL ACCESSORIES



▲ ITSW001 Switch 5-port auto mdi/mdix function

ITSW001

Switch 5-port auto mdi/mdix function.

Category: Accessories

Subcategory: desktop switch

Code: ITSW001



 5-Port 10/100Mbps Desktop Switch. It provides an easy way to expand your wired network. It can process data at a rate of up to 200Mbps making it an ideal choice for expanding your high performance wired network. Moreover, all ports support Auto MDI/MDIX function, eliminating the need for crossover cables or Uplink ports

 Switch 5 ports 10/100 Mbps. Fournit un moyen facile d'étendre votre réseau câblé à haute performance étant en mesure de traiter des données à une vitesse allant jusqu'à 200 Mbps. En outre, tous les ports supportent la fonction Auto MDI / MDIX, éliminant le besoin de câbles croisés ou des ports Uplink.

 Switch 5 porte 10/100Mbps. Fornisce un modo semplice per espandere la vostra rete cablata ad alte prestazioni essendo in grado di elaborare dati a una velocità fino a 200Mbps. Inoltre, tutte le porte supportano la funzione Auto MDI / MDIX, eliminando la necessità di cavi incrociati o di porte Uplink.

OPTIONAL ACCESSORIES



▲ ITAP001 Access point for metal/large boat.

Satellite Position

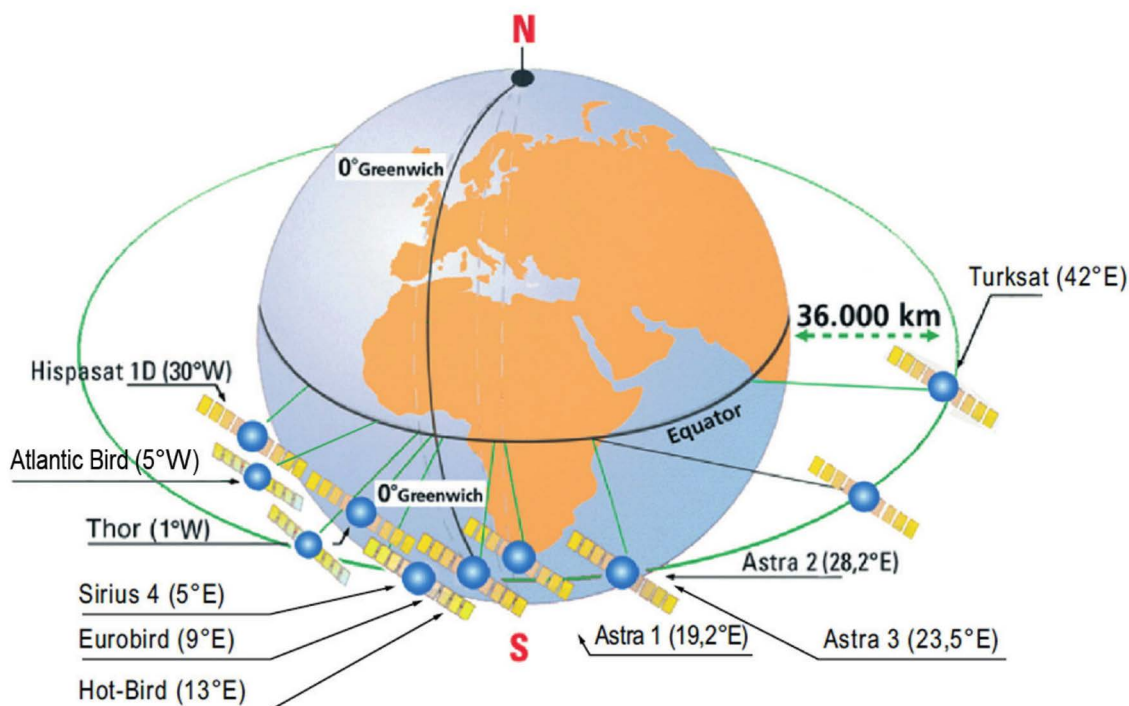

🇬🇧 INFORMATION ABOUT TV AND RADIO SATELLITES POSITION

The satellites for telecommunication are positioned on a geostationary orbit around the earth, synchronized with terrestrial rotation and relatively static according to the Greenwich meridian, at a height of about 36.000 km above the equator. The satellites are fed by solar panels and they concentrate the transmission of the signal on relatively small terrestrial areas (footprint.) The effect of the satellites' signal is of highest intensity particularly in the centre of the area and weaker at the extremities. The footprints show the satellite coverage areas of the main earth satellites interacting with Glomex satellite antennas.

🇫🇷 INFORMATIONS SUR LE POSITIONNEMENT DES SATELLITES RADIO ET TV

Les satellites pour les télécommunications sont situés sur une orbite géostationnaire tout autour de la Terre synchronisée avec la rotation de la Terre et relativement statique par rapport au méridien de Greenwich, à une altitude d'environ 36.000 km au-dessus de l'équateur. Les satellites sont alimentés par des panneaux solaires et ils concentrent la transmission du signal sur des zones terrestres relativement petites (foot-print). Le signal du satellite est au maximum de son intensité au centre de la zone et va en s'atténuant vers ses extrémités. Les footprints montrent les zones de couverture des principaux satellites sur la Terre au moyen des antennes satellitaires Glomex.

🇮🇹 INFORMAZIONI SUL POSIZIONAMENTO DEI SATELLITI RADIO E TV

I satelliti per le telecomunicazioni sono posizionati in un'orbita geostazionaria intorno alla Terra, sincronizzata con la rotazione terrestre e relativamente statica rispetto al meridiano di Greenwich, ad un'altitudine di circa 36.000 km sopra l'equatore. I satelliti sono alimentati da pannelli solari e concentrano l'emissione del segnale su aree terrestri relativamente piccole (foot-print). L'effetto del segnale satellitare è di massima intensità al centro dell'area e va attenuandosi alle estremità. Nei foot-print riportati sono illustrate le zone di copertura dei principali satelliti sulla Terra, utilizzando le antenne satellitari Glomex.

& Foot-print (satellite coverage area)

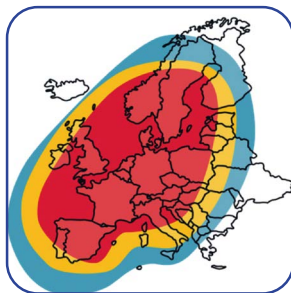

▲ ASTRA 1 (19.2° E)



▲ ASTRA 2 UK (28.2° E)

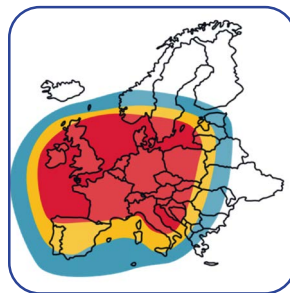

▲ ASTRA 2 (28.2° E)



▲ ASTRA 3 (23.5° E)

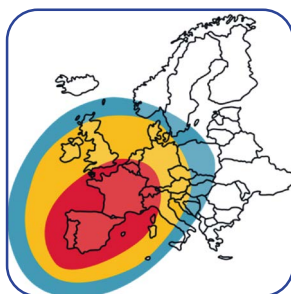

▲ HISPASAT (30° W)

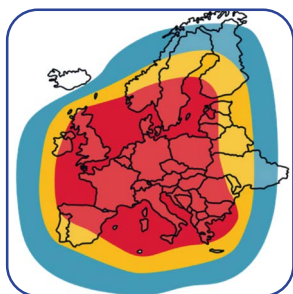

▲ HOTBIRD (13° E)



▲ SIRIUS (4.8° E NORDIC)

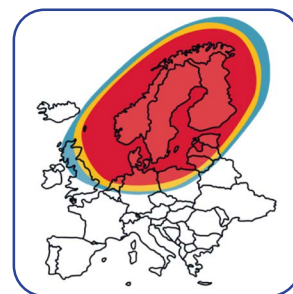

▲ THOR (1° W NORDIC)

● 39cm (15")
DISH PANDORA

● 47cm (18")
DISH RHEA / SATURN 4

● 60cm (24")
DISH MARS / RHINE
58x32cm (23x13")
DISH DANUBE

🇬🇧 FOOT-PRINT BY ANTENNA SIZE

These maps show the satellite coverage area for each Glomex satellite TV antennas. The performance of the satellite antenna is affected by meteorological conditions from the navigation area (in the case of bad weather, signals will be weaker and the image quality could decrease, it can even completely fade.) Each satellite covers a specific geographic area and the size of the dish should be suitable for signal reception in the places of your stay.

🇫🇷 ZONE DE COUVERTURE SELON LA DIMENSION DE L'ANTENNE

Les cartes montrent la zone de couverture du satellite pour chaque antenne Glomex. La performance des antennes satellitaires dépend des conditions météorologiques (en cas de mauvais temps les signaux deviennent plus faibles et la qualité de l'image pourrait diminuer et l'image elle-même disparaître), de la zone de navigation (chaque satellite couvre une zone géographique spécifique) et de la dimension de l'antenne (la dimension du disque parabolique doit être capable de recevoir le signal dans les lieux choisis).

🇮🇹 FOOT-PRINT PER DIMENSIONE ANTENNA

Nelle mappe sono rappresentate le zone di copertura di ogni satellite per ciascuna antenna Glomex. La performance delle antenne satellitari è influenzata dalle condizioni meteorologiche (in caso di maltempo i segnali saranno più deboli e la qualità delle immagini potrebbe diminuire fino a svanire completamente), dall'area di navigazione (ciascun satellite copre una specifica area geografica) e dalla dimensione dell'antenna stessa (la dimensione del disco parabolico deve essere idonea a ricevere il segnale nei luoghi prescelti).



NEO” satellite TV antennas are managed via the free Glomex SAT App available for iOS and Android devices. By downloading the app, it is possible to connect to the satellite TV antenna via Bluetooth® and with just one click:

- ▶ Update the firmware of the antenna and control unit
- ▶ Update the antenna’s list of satellites and their frequencies
- ▶ Select and change satellites from the current database
- ▶ Send antenna operating parameters to technical support in case of need

**APP DEVELOPED WITH A TWO LEVEL STRUCTURE
ONE FOR THE END CUSTOMER
ONE FOR THE TECHNICIANS**

WHAT CAN THE END USER DO? BASIC LEVEL	WHAT CAN THE TECHNICIAN DO? ADVANCED LEVEL
<ul style="list-style-type: none"> ▶ Select satellites ▶ Read the parameters of the satellites ▶ Update the list of satellites ▶ Send antenna logs to Glomex support 	<ul style="list-style-type: none"> ▶ Update the Antenna Board firmware ▶ Update the Control Unit Firmware ▶ Register the antenna by scanning the bar-code ▶ Send the antenna logs to Glomex support ▶ Changing satellite frequencies
<p>ALL WITH ONE CLICK NO CABLES / NO SD CARDS</p>	

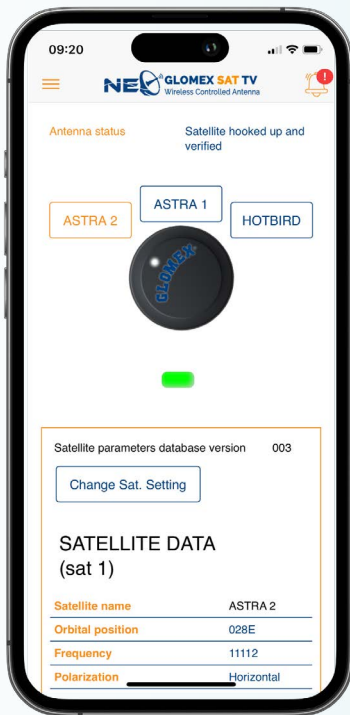

Control panel

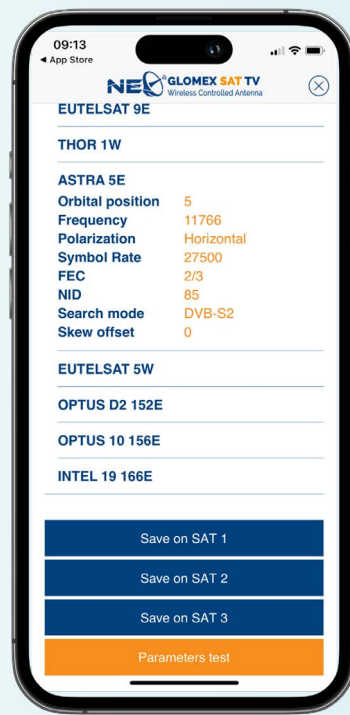

Database satellites

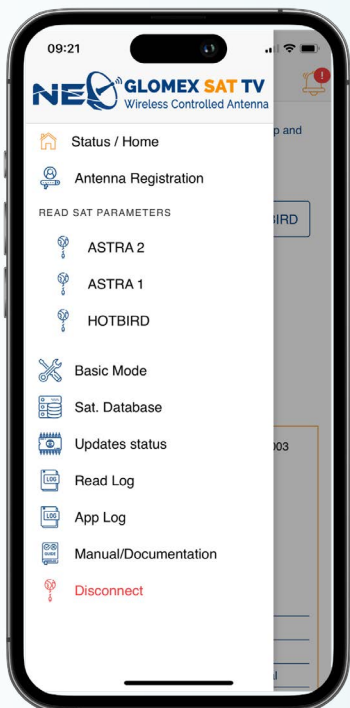

Antenna updates

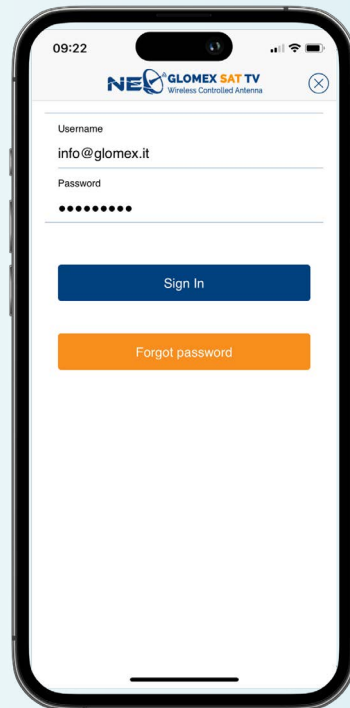

Antenna updates



Pandora "Neo"

39cm (15") dish diameter, wireless controlled, 1 output

Category: SAT TV

Subcategories: Marine Antennas

Code: V8001N



🇮🇹 Pandora "NEO" is the new wireless control FULL-HD / 4K satellite TV antenna with 39cm (15") dish. The "NEO" antennas are equipped with a super fast satellite locking system even in extreme rough sea conditions thanks to totally renewed electronics and mechanics: more powerful processor, faster driver and more robust structure. Furthermore, the new electronics have been designed to make Pandora "NEO" super silent, both in the satellite search phase and in the tracking phase. Thanks to the introduction of a brand new GPS system, Pandora "NEO" saves previous navigation positions, as well as guarantee increased signal reception performance even at the edges of the signal coverage area. Like all new Glomex "NEO" satellite TV antennas, Pandora "NEO" is managed via the free App available for iOS and Android devices.

By downloading the app, you can manage the "NEO" satellite TV antennas in one click via Bluetooth® with your own smartphone/tablet and:

- ▶ update the satellites list;
- ▶ update the antenna;
- ▶ select and change satellites;
- ▶ send the operating parameters of the antenna to technical assistance in case of need.

Supplied accessories:

- ▶ control unit 12v;
- ▶ 10 M (33') coaxial cable;
- ▶ 1,5 M (5') coaxial cable;
- ▶ high thickness synthetic rubber gasket.

TECHNOLOGY	DVB-S2 4K FULL HD
DISH DIAMETER	390 mm (15")
RADOME DIMENSIONS	420×450 mm (16×18")
LNB	Universal single
APP	yes
COAX CABLE	1
RECEIVER OUTPUT	1
WEIGHT	6 kg (13.3 lb)
TRACKING	50° sec
GAIN	33 dB (12 GHz)
SKEW	Manual
DISH TYPE	Prime Focus + HPD
POLARIZATION	Linear (H + V)
LNB FREQUENCY RANGE	10,7 – 12,75 GHz LNB universal
RADOME TYPE	U.V. resistant
POWER REQUIREMENT	12 Vdc
OPERATING TEMPERATURE RANGE	-20° +55°
AZIMUTH	Unlimited
ELEVATION	0° / 90°
TYPE OF STABILIZATION	gyro on 2 axis + 3° axis by interpolation
SATELLITE IDENTIFICATION	NIT (Network Information Table)
MIN EIRP	50 dBW
FUTURE UPGRADES READY	yes
CONTROL UNIT	unlimited

More info on www.glomex.it

▶ Pandora "NEO" est la nouvelle antenne TV satellite FULL-HD / 4K à commande sans fil avec disque de 39cm. Les antennes "NEO" sont équipées d'un système de verrouillage satellite ultra rapide même dans des conditions de mer extrêmement agitée grâce à une électronique et une mécanique totalement renouvelées: processeur plus puissant, pilote plus rapide et structure plus robuste. De plus, la nouvelle électronique a été conçue pour rendre Pandora «NEO» super silencieux, à la fois dans la phase de recherche par satellite et dans la phase de poursuite. Grâce à l'introduction d'un tout nouveau système GPS, Pandora "NEO" mémorise les positions de navigation précédemment parcourues et garantit des performances accrues de réception du signal, même aux abords de la zone de couverture du signal. Comme toutes les nouvelles antennes de télévision par satellite Glomex "NEO", Pandora "NEO" est géré via l'application gratuite Glomex SAT disponible pour les appareils iOS et Android.

En téléchargeant l'application, vous pouvez vous connecter à l'antenne TV satellite via Bluetooth® en un seul clic:

- ▶ mettre à jour l'antenne;
- ▶ mettre à jour la liste des satellites d'antenne;
- ▶ sélectionner et modifier les satellites;
- ▶ envoyer les paramètres de fonctionnement de l'antenne à l'assistance technique en cas de besoin.

Accessoires inclus:

- ▶ control unit 12 Vdc;
- ▶ câble coaxial 10m;
- ▶ câble coaxial 1,5m;
- ▶ joint en gomme synthétique.

▶ Pandora "NEO" è la nuova antenna TV satellitare FULL-HD/4K a controllo wireless con disco da 39cm. Le antenne "NEO" sono dotate di un sistema di aggancio satellitare ultrarapido anche in condizioni di mare estremamente mosso grazie a elettronica e meccanica completamente nuove: processore più potente, pilota più veloce e struttura più robusta. Inoltre, la nuova elettronica è stata studiata per rendere il Pandora "NEO" super silenzioso, sia in fase di ricerca satellitare che in fase di tracciamento. Con l'introduzione di un nuovissimo sistema GPS, Pandora "NEO" ricorda le posizioni di navigazione precedentemente navigate e garantisce migliori prestazioni di ricezione del segnale anche vicino all'area di copertura del segnale. Come tutte le nuove antenne TV satellitari Glomex "NEO", Pandora "NEO" è gestita tramite l'applicazione gratuita Glomex SAT disponibile per dispositivi iOS e Android.

Scaricando l'app, puoi connetterti all'antenna TV satellitare tramite Bluetooth® con un solo clic:

- ▶ aggiorna l'antenna;
- ▶ aggiornare l'elenco dei satelliti antenna;
- ▶ selezionare e modificare i satelliti;
- ▶ inviare i parametri di funzionamento dell'antenna al supporto;
- ▶ tecnico se necessario.

Accessori inclusi:

- ▶ centralina 12 Vdc;
- ▶ cavo coassiale 10m;
- ▶ cavo coassiale da 1,5 m;
- ▶ guarnizione in gomma sintetica.

SUPPLIED ACCESSORIES



▲ 12Vdc control unit



▲ 10m (33') coax cable



▲ 1,5m (5') coaxial cable



▲ High thickness synthetic rubber gasket

OPTIONAL ACCESSORIES



▲ V9500 Mount



▲ V8001NTWIN Twin Radome



Rhea "Neo"

47cm (18") dish diameter, wireless controlled, 1 output: the best choice for watching satellite FULL HD channels

Category: SAT TV

Subcategories: Marine Antennas

Code: V8100N



Rhea "NEO" is the new wireless control FULL-HD / 4K satellite TV antenna with 47cm (18") dish. The "NEO" antennas are equipped with a super-fast satellite locking system even in extreme rough sea conditions thanks to totally renewed electronics and mechanics: more powerful processor, faster driver and more robust structure.

Furthermore, the new electronics have been designed to make Rhea "NEO" super silent, both in the satellite search phase and in the tracking phase. Thanks to the introduction of a brand-new GPS system, Rhea "NEO" saves previous navigation positions, as well as guarantee increased signal reception performance even at the edges of the signal coverage area. Like all new Glomex "NEO" satellite TV antennas, Rhea "NEO" is managed via the free App available for iOS and Android devices.

By downloading the app, you can manage the "NEO" satellite TV antennas in one click via Bluetooth® with your own smartphone/tablet and:

- ▶ update the satellites list;
- ▶ update the antenna;
- ▶ select and change satellites;
- ▶ send the operating parameters of the antenna to technical assistance in case of need.

Supplied accessories:

- ▶ 12/24Vdc control unit;
- ▶ 10m (33') coaxial cable;
- ▶ 1,5m (5') coaxial cable;
- ▶ high thickness synthetic rubber gasket.

TECHNOLOGY	DVB-S2 4K FULL HD
DISH DIAMETER	470 mm (18")
RADOME DIMENSIONS (BXH)	500 x 560 mm (20x22")
LNB	Universal single
APP	yes
COAX CABLE FROM ANTENNA	1
RECEIVER OUTPUT	1
WEIGHT	13 kg (28.5 lb)
TRACKING	50° sec
GAIN	35 dB (12 GHz)
SKEW	Manual
DISH TYPE	Prime Focus + HPD
POLARIZATION	Linear (H + V)
LNB FREQUENCY RANGE	10,7 – 12,75 GHz LNB universal
RADOME TYPE	U.V. resistant
POWER REQUIREMENT	12/24 Vdc (1,5 Ah)
OPERATING TEMPERATURE RANGE	-20° +55°
AZIMUTH	Unlimited
ELEVATION	0° / 90°
TYPE OF STABILIZATION	gyro on 2 axis + 3° axis by interpolation
SATELLITE IDENTIFICATION	NIT (Network Information Table)
MIN EIRP	49 dBw
FUTURE UPGRADES READY	yes
CONTROL UNIT	unlimited

More info on www.glomex.it

Rhea "NEO" est la nouvelle antenne TV satellite FULL-HD / 4K à commande sans fil avec disque de 47cm. Les antennes "NEO" sont équipées d'un système de verrouillage satellite ultra rapide même dans des conditions de mer extrêmement agitée grâce à une électronique et une mécanique totalement renouvelées: processeur plus puissant, pilote plus rapide et structure plus robuste.

De plus, la nouvelle électronique a été conçue pour rendre Rhea "NEO" super silencieux, à la fois dans la phase de recherche par satellite et dans la phase de poursuite. Grâce à l'introduction d'un tout nouveau système GPS, Rhea "NEO" mémorise les positions de navigation précédemment parcourues et garantit des performances accrues de réception du signal, même aux abords de la zone de couverture du signal. Comme toutes les nouvelles antennes de télévision par satellite Glomex "NEO", Rhea "NEO" est géré via l'application gratuite Glomex SAT disponible pour les appareils iOS et Android.

En téléchargeant l'application, vous pouvez vous connecter à l'antenne TV satellite via Bluetooth® en un seul clic:

- ▶ mettre à jour l'antenne;
- ▶ mettre à jour la liste des satellites d'antenne;
- ▶ sélectionner et modifier les satellites;
- ▶ envoyer les paramètres de fonctionnement de l'antenne à l'assistance technique en cas de besoin.

Accessoires inclus:

- ▶ control unit 12/24 Vdc;
- ▶ câble coaxial 10m;
- ▶ câble coaxial 1,5m;
- ▶ joint en gomme synthétique.

Pandora "NEO" è la nuova antenna TV satellitare FULL-HD/4K a controllo wireless con disco da 39cm. Le antenne "NEO" sono dotate di un sistema super veloce di aggancio del satellite anche in condizioni estreme di mare mosso grazie ad una elettronica e meccanica totalmente rinnovate: processore più potente, driver più veloce e struttura più robusta.

Inoltre, la nuova elettronica è stata progettata per rendere Pandora "NEO" super silenziosa, sia in fase di ricerca del satellite sia in fase di tracking. Grazie all'introduzione di un nuovissimo sistema gps, pandora "neo" memorizza le posizioni di navigazione precedentemente percorse e garantisce prestazioni di ricezione del segnale incrementate anche ai margini dell'area di copertura del segnale. Come tutte le nuove antenne tv satellitari "neo" di glomex, pandora "neo" è gestita tramite l'app gratuita glomex sat disponibile per i dispositivi ios e android.

Scaricando l'app è possibile collegarsi all'antenna tv satellitare tramite bluetooth® e con un solo clic:

- ▶ aggiornare l'antenna;
- ▶ aggiornare l'elenco dei satelliti dell'antenna;
- ▶ selezionare e cambiare i satelliti;
- ▶ inviare i parametri operativi dell'antenna all'assistenza tecnica in caso di necessità.

Prodotti inclusi con l'antenna:

- ▶ unità di controllo 12/24 Vdc;
- ▶ cavo coassiale da 10m;
- ▶ cavo coassiale da 1,5m;
- ▶ guarnizione in gomma.

SUPPLIED ACCESSORIES



▲ 12Vdc control unit



▲ 10m (33') coax cable



▲ 1,5m (5') coaxial cable



▲ High thickness synthetic rubber gasket

OPTIONAL ACCESSORIES



▲ v9500 Mount



▲ v8100NTWIN twin radome



Saturn 4 "Neo"

47cm (18") dish diameter, wireless controlled, 1/16 outputs

Category: SAT TV

Subcategories: Marine Antennas

Code: V9104N



🇮🇹 Saturn 4 "NEO" is the new FULL-HD / 4K wirelessly controlled satellite TV antenna with 47cm dish to use up to 16 TVs simultaneously. Like all Glomex "NEO" satellite TV antennas, Saturn 4 is equipped with a super fast satellite locking system even in extreme rough sea conditions thanks to totally renewed electronics and mechanics: more powerful processor, faster driver and more robust. Furthermore, the new electronics have been designed to have extremely quiet satellite TV antennas, both in the satellite search phase and in the tracking phase. Thanks to the introduction of a brand new GPS system, the new "NEO" satellite TV antennas save the previous the navigation positions and guarantee increased signal reception performance even at the edges of the signal coverage area. Saturn 4 "NEO" is managed through the free Glomex SAT TV App available for iOS and Android devices.

By downloading the app, you can manage the "NEO" satellite TV antennas in one click via Bluetooth® with your own smartphone/tablet and:

- ▶ update the satellites list
- ▶ update the antenna
- ▶ select and change satellites
- ▶ send the operating parameters of the antenna to technical assistance in case of need.

Supplied accessories:

- ▶ 12/24Vdc control unit.
- ▶ 10m (33') coaxial cable.
- ▶ 1,5m (5') coaxial cable.
- ▶ High thickness synthetic rubber gasket.

TECHNOLOGY	DVB-S2 4K FULL HD
DISH DIAMETER	470 mm (18")
RADOME DIMENSIONS	500x560 mm (20x22")
LNB	Universal single
APP	yes
COAX CABLE	4
RECEIVER OUTPUT	1/16
WEIGHT	13 kg (28.5 lb)
TRACKING	50° sec
GAIN	35 dB (12 GHz)
SKEW	Manual
DISH TYPE	Prime Focus + HPD
POLARIZATION	Linear (H + V)
LNB FREQUENCY RANGE	10,7 – 12,75 GHz LNB universal
RADOME TYPE	U.V. resistant
POWER REQUIREMENT	12 Vdc
OPERATING TEMPERATURE RANGE	-20° +55°
AZIMUTH	Unlimited
ELEVATION	0° / 90°
TYPE OF STABILIZATION	gyro on 2 axis + 3° axis by interpolation
SATELLITE IDENTIFICATION	NIT (Network Information Table)
MIN EIRP	49 dBW
FUTURE UPGRADES READY	yes
CONTROL UNIT	unlimited

More info on www.glomex.it

❶ Saturn 4 "NEO" est la nouvelle antenne TV satellite FULL-HD / 4K contrôlée sans fil avec un disque de 47 cm pour utiliser jusqu'à 16 téléviseurs simultanément. Comme toutes les antennes de télévision par satellite Glomex "NEO", Saturn 4 est équipé d'un système de verrouillage par satellite ultra-rapide même dans des conditions de mer extrêmement agitée grâce à une électronique et une mécanique totalement renouvelées: processeur plus puissant, pilote plus rapide et plus robuste. En outre, la nouvelle électronique a été conçue pour avoir des antennes de télévision par satellite extrêmement silencieuses, à la fois dans la phase de recherche satellite et dans la phase de poursuite. Grâce à l'introduction d'un tout nouveau système GPS, les nouvelles antennes de télévision par satellite "NEO" mémorisent les positions de navigation précédemment parcourues et garantissent des performances accrues de réception du signal, même en bordure de la zone de couverture du signal. Saturn 4 "NEO" est géré via l'application gratuite Glomex SAT TV disponible pour les appareils iOS et Android.

En téléchargeant l'application, vous pouvez vous connecter à l'antenne TV satellite via Bluetooth® en un seul clic:

- ▶ mettre à jour l'antenne.
- ▶ mettre à jour la liste des satellites d'antenne.
- ▶ sélectionner et modifier les satellites.
- ▶ envoyer les paramètres de fonctionnement de l'antenne à l'assistance technique en cas de besoin.

Accessoires inclus:

- ▶ control unit 12/24 Vdc.
- ▶ Câble coaxial 10m.
- ▶ Câble coaxial 1,5m.
- ▶ Joint en gomme synthétique

❷ Saturn 4 "NEO" è la nuova antenna TV satellitare FULL-HD/4K a controllo wireless con disco da 47cm per utilizzare massimo 16 TV contemporaneamente. Come tutte le antenne TV satellitari Glomex "NEO", Saturn 4 è dotata di un sistema super veloce di aggancio del satellite anche in condizioni estreme di mare mosso grazie ad una elettronica e meccanica totalmente rinnovate: processore più potente, driver più veloce e struttura più robusta. Inoltre, la nuova elettronica è stata progettata per avere delle antenne TV satellitari estremamente silenziose, sia in fase di ricerca del satellite sia in fase di tracking. Grazie all'introduzione di un nuovissimo sistema GPS, le nuove antenne TV satellitari "NEO" memorizzano le posizioni di navigazione precedentemente percorse e garantiscono prestazioni di ricezione del segnale incrementate anche ai margini dell'area di copertura del segnale. Saturn 4 "NEO" è gestita tramite l'App gratuita Glomex SAT TV disponibile per i dispositivi iOS e Android.

Scaricando l'App è possibile collegarsi all'antenna TV satellitare tramite Bluetooth® e con un solo clic:

- ▶ aggiornare l'antenna.
- ▶ aggiornare l'elenco dei satelliti dell'antenna.
- ▶ selezionare e cambiare i satelliti.
- ▶ inviare i parametri operativi dell'antenna all'assistenza tecnica in caso di necessità.

Prodotti inclusi con l'antenna:

- ▶ unita' di controllo 12/24 Vdc.
- ▶ Cavo coassiale da 10m.
- ▶ Cavo coassiale da 1,5m.
- ▶ Guarnizione in gomma.

SUPPLIED ACCESSORIES



▲ 12Vdc control unit



▲ 4 x 10m (33') coax cables



▲ 1,5m (5') coaxial cable



▲ High thickness synthetic rubber gasket

OPTIONAL ACCESSORIES



▲ V9500 Mount



▲ V9104NTWIN twin radome



Saturn 4 dCSS "Neo"

47cm (18") dish diameter, wireless controlled, only 1 cable for 1/16 outputs

Category: SAT TV

Subcategories: dCSS Marine Antennas

Code: V9104N/DCSS



🇮🇹 Saturn 4 "NEO" DCSS is the new FULL-HD / 4K wirelessly controlled satellite TV antenna with 47cm disc to use up to 16 TVs simultaneously. Developed with the dCSS / SCR technology, Saturn 4 "NEO" DCSS has been specially manufactured to be used with the dCSS decoders, for example the Sky Q decoders, and to exploit all their features (such as recording a program while watching a other channel). The dCSS technology also has the great advantage of making installation extremely simple and fast thanks to a single cable that comes down from the antenna even for multi-output installations. Like all Glomex "NEO" satellite TV antennas, Saturn 4 is equipped with a super fast satellite locking system even in extreme rough sea conditions thanks to totally renewed electronics and mechanics: more powerful processor, faster driver and more robust. Furthermore, the new electronics have been designed to have extremely quiet satellite TV antennas, both in the satellite search phase and in the tracking phase. Thanks to the introduction of a brand new GPS system, the new "NEO" satellite TV antennas save the previous the navigation positions and guarantee increased signal reception performance even at the edges of the signal coverage area. Saturn 4 "NEO" is managed through the free Glomex SAT TV App available for iOS and Android devices.

By downloading the app, you can manage the "NEO" satellite TV antennas in one click via Bluetooth® with your own smartphone/tablet and:

- ▶ Update the satellites list
- ▶ Update the antenna
- ▶ Select and change satellites
- ▶ Send the operating parameters of the antenna to technical assistance in case of need

Supplied accessories:

- ▶ 12/24 Vdc control unit
- ▶ 10m (33') coaxial cable.
- ▶ 1,5m (5') coaxial cable.
- ▶ High thickness synthetic rubber gasket.

TECHNOLOGY	DVB-S2 4K FULL HD
DISH DIAMETER	470 mm (18")
RADOME DIMENSIONS	500×560 mm (20×22")
LNB	Universal single
APP	yes
COAX CABLE	1
RECEIVER OUTPUT	1/16
WEIGHT	13 kg (28.5 lb)
TRACKING	50° sec
GAIN	35 dB (12 GHz)
SKEW	Manual
DISH TYPE	Prime Focus + HPD
POLARIZATION	Linear (H + V)
LNB FREQUENCY RANGE	10,7 – 12,75 GHz LNB universal
RADOME TYPE	U.V. resistant
POWER REQUIREMENT	12 Vdc
OPERATING TEMPERATURE RANGE	-20° +55°
AZIMUTH	Unlimited
ELEVATION	0° / 90°
TYPE OF STABILIZATION	gyro on 2 axis + 3° axis by interpolation
SATELLITE IDENTIFICATION	NIT (Network Information Table)
MIN EIRP	49 dBW
FUTURE UPGRADES READY	yes
CONTROL UNIT	unlimited

More info on www.glomex.it

▶ Saturn 4 "NEO" DCSS est la nouvelle antenne TV satellite FULL-HD / 4K contrôlée sans fil avec un disque de 47 cm pour utiliser jusqu'à 16 téléviseurs simultanément. Avec la technologie dCSS / SCR, Saturn 4 "NEO" DCSS est été spécialement développée pour être utilisée avec les nouveaux décodeurs dCSS, par exemple les décodeurs Sky Q, et pour exploiter toutes leurs fonctionnalités (comme l'enregistrement d'un programme tout en regardant un autre canal). La technologie dCSS présente également le grand avantage de rendre l'installation extrêmement simple et rapide grâce à un seul câble qui descend de l'antenne même pour les installations multi-sorties. Comme toutes les antennes de télévision par satellite Glomex "NEO", Saturn 4 est équipé d'un système de verrouillage par satellite ultra-rapide même dans des conditions de mer extrêmement agitée grâce à une électronique et une mécanique totalement renouvelées: processeur plus puissant, pilote plus rapide et plus robuste. En outre, la nouvelle électronique a été conçue pour avoir des antennes de télévision par satellite extrêmement silencieuses, à la fois dans la phase de recherche satellite et dans la phase de poursuite. Grâce à l'introduction d'un tout nouveau système GPS, les nouvelles antennes de télévision par satellite "NEO" mémorisent les positions de navigation précédemment parcourues et garantissent des performances accrues de réception du signal, même en bordure de la zone de couverture du signal. Les modèles d'antenne dotés de la nouvelle Saturn 4 «NEO» est géré via l'application gratuite Glomex SAT TV disponible pour les appareils iOS et Android.

En téléchargeant l'application, vous pouvez vous connecter à l'antenne TV satellite via Bluetooth® en un seul clic:

- ▶ Mettre à jour l'antenne.
- ▶ Mettre à jour la liste des satellites d'antenne.
- ▶ Sélectionner et modifier les satellites.
- ▶ Envoyer les paramètres de fonctionnement de l'antenne à l'assistance technique en cas de besoin.

Accessoires inclus:

- ▶ Control unit 12/24 Vdc.
- ▶ Câble coaxial 10m.
- ▶ Câble coaxial 1,5m.
- ▶ Joint en gomme synthétique

▶ Saturn 4 "NEO" DCSS è la nuova antenna TV satellitare FULL-HD/4K a controllo wireless con disco da 47cm per utilizzare massimo 16 TV contemporaneamente. Questa versione è stata sviluppata per i decoder dCSS, ad esempio i decoder Sky Q, e per sfruttarne tutte le loro funzionalità (come la registrazione di un programma in contemporanea alla visione di un altro canale). La tecnologia dCSS inoltre ha il grande vantaggio di rendere l'installazione estremamente semplice e veloce grazie ad un unico cavo che scende dall'antenna anche per le installazioni a multi-uscita. Come tutte le antenne TV satellitari Glomex "NEO", Saturn 4 è dotata di un sistema super veloce di aggancio del satellite anche in condizioni estreme di mare mosso grazie ad una elettronica e meccanica totalmente rinnovate: processore più potente, driver più veloce e struttura più robusta. Inoltre, la nuova elettronica è stata progettata per avere delle antenne TV satellitari estremamente silenziose, sia in fase di ricerca del satellite sia in fase di tracking. Grazie all'introduzione di un nuovissimo sistema GPS, le nuove antenne TV satellitari "NEO" memorizzano le posizioni di navigazione precedentemente percorse e garantiscono prestazioni di ricezione del segnale incrementate anche ai margini dell'area di copertura del segnale. Saturn 4 "NEO" è gestita tramite l'App gratuita Glomex SAT TV disponibile per i dispositivi iOS e Android.

Scaricando l'App è possibile collegarsi all'antenna TV satellitare tramite Bluetooth® e con un solo clic:

- ▶ Aggiornare l'antenna.
- ▶ Aggiornare l'elenco dei satelliti dell'antenna.
- ▶ Selezionare e cambiare i satelliti.
- ▶ Inviare i parametri operativi dell'antenna all'assistenza tecnica in caso di necessità.

Prodotti inclusi con l'antenna:

- ▶ Unita' di controllo 12/24 Vdc.
- ▶ Cavo coassiale da 10m.
- ▶ Cavo coassiale da 1,5m.
- ▶ Guarnizione in gomma.

SUPPLIED ACCESSORIES



▲ 12/24Vdc control unit



▲ 10m (33') coax cable



▲ 1,5m (5') coaxial cable



▲ High thickness synthetic rubber gasket

OPTIONAL ACCESSORIES



▲ V9500 Mount



▲ V9104NTWIN rwin radome



Mars "Neo"

60cm (24") dish diameter, wireless controlled, 1 output

Category: SAT TV

Subcategories: Marine Antennas

Code: V9801N



MADE IN ITALY



Mars "NEO" is the new FULL-HD / 4K wirelessly controlled satellite TV antenna with 60cm dish with 1 decoder output. Like all Glomex "NEO" satellite TV antennas, Mars "NEO" is equipped with a super fast satellite locking system even in extreme rough sea conditions thanks to totally renewed electronics and mechanics: more powerful processor, faster driver and more robust. Furthermore, the new electronics have been designed to have extremely quiet satellite TV antennas, both in the satellite search phase and in the tracking phase. Thanks to the introduction of a brand new GPS system, the new "NEO" satellite TV antennas save the previous the navigation positions and guarantee increased signal reception performance even at the edges of the signal coverage area. Mars "NEO" is managed through the free Glomex SAT TV App available for iOS and Android devices.

By downloading the app, you can manage the "NEO" satellite TV antennas in one click via Bluetooth® with your own smartphone/tablet and:

- ▶ update the satellites list
- ▶ update the antenna
- ▶ select and change satellites
- ▶ send the operating parameters of the antenna to technical assistance in case of need .

Supplied accessories:

- ▶ 12/24 Vdc control unit.
- ▶ 10m (33') coaxial cable.
- ▶ 1,5m (5') coaxial cable.
- ▶ High thickness synthetic rubber gasket

TECHNOLOGY	DVB-S2 4K FULL HD
DISH DIAMETER	600 mm (24")
RADOME DIMENSIONS	600×660 mm (26×26")
LNB	Universal single
APP	yes
COAX CABLE	1
RECEIVER OUTPUT	1
WEIGHT	16 kg (35,3 lb)
TRACKING	50° sec
GAIN	36,5 dB (12 GHz)
SKEW	Manual
DISH TYPE	Prime Focus + HPD
POLARIZATION	Linear (H + V)
LNB FREQUENCY RANGE	10,7 – 12,75 GHz LNB universal
RADOME TYPE	U.V. resistant
POWER REQUIREMENT	12 Vdc
OPERATING TEMPERATURE RANGE	-20° +55°
AZIMUTH	Unlimited
ELEVATION	5° / 90°
TYPE OF STABILIZATION	gyro on 2 axis + 3° axis by interpolation
SATELLITE IDENTIFICATION	NIT (Network Information Table)
MIN EIRP	47 dBW
FUTURE UPGRADES READY	yes
CONTROL UNIT	unlimited

More info on www.glomex.it

🇮🇹 Mars "NEO" est la nouvelle antenne TV satellite FULL-HD / 4K contrôlée sans fil avec un disque de 60 cm avec une sortie pour decodeur. Comme toutes les antennes de télévision par satellite Glomex "NEO", Mars "NEO" est équipé d'un système de verrouillage par satellite ultra-rapide même dans des conditions de mer extrêmement agitée grâce à une électronique et une mécanique totalement renouvelées: processeur plus puissant, pilote plus rapide et plus robuste. En outre, la nouvelle électronique a été conçue pour avoir des antennes de télévision par satellite extrêmement silencieuses, à la fois dans la phase de recherche satellite et dans la phase de poursuite. Grâce à l'introduction d'un tout nouveau système GPS, les nouvelles antennes de télévision par satellite "NEO" mémorisent les positions de navigation précédemment parcourues et garantissent des performances accrues de réception du signal, même en bordure de la zone de couverture du signal. Mars "NEO" est géré via l'application gratuite Glomex SAT TV disponible pour les appareils iOS et Android.

En téléchargeant l'application, vous pouvez vous connecter à l'antenne TV satellite via Bluetooth® en un seul clic:

- ▶ mettre à jour l'antenne.
- ▶ mettre à jour la liste des satellites d'antenne.
- ▶ sélectionner et modifier les satellites.
- ▶ envoyer les paramètres de fonctionnement de l'antenne à l'assistance technique en cas de besoin.

Accessoires inclus:

- ▶ Control unit 12/24 Vdc.
- ▶ Câble coaxial 10m.
- ▶ Câble coaxial 1,5m.
- ▶ Joint en gomme synthétique

🇮🇹 Mars "NEO" è la nuova antenna TV satellitare FULL-HD/4K a controllo wireless con disco da 60cm con una uscita per decoder. Come tutte le antenne TV satellitari Glomex "NEO", Mars "NEO" è dotata di un sistema super veloce di aggancio del satellite anche in condizioni estreme di mare mosso grazie ad una elettronica e meccanica totalmente rinnovate: processore più potente, driver più veloce e struttura più robusta. Inoltre, la nuova elettronica è stata progettata per avere delle antenne TV satellitari estremamente silenziose, sia in fase di ricerca del satellite sia in fase di tracking. Grazie all'introduzione di un nuovissimo sistema GPS, le nuove antenne TV satellitari "NEO" memorizzano le posizioni di navigazione precedentemente percorse e garantiscono prestazioni di ricezione del segnale incrementate anche ai margini dell'area di copertura del segnale. Mars "NEO" è gestita tramite l'App gratuita Glomex SAT TV disponibile per i dispositivi iOS e Android.

Scaricando l'App è possibile collegarsi all'antenna TV satellitare tramite Bluetooth® e con un solo clic:

- ▶ aggiornare l'antenna.
- ▶ aggiornare l'elenco dei satelliti dell'antenna.
- ▶ selezionare e cambiare i satelliti.
- ▶ inviare i parametri operativi dell'antenna all'assistenza tecnica in caso di necessità.

Prodotti inclusi con l'antenna:

- ▶ unità di controllo 12/24 Vdc.
- ▶ Cavo coassiale da 10m.
- ▶ Cavo coassiale da 1,5m.
- ▶ Guarnizione in gomma.

SUPPLIED ACCESSORIES



▲ 12/24Vdc control unit



▲ 10m (33') coax cable



▲ 1,5m (5') coaxial cable

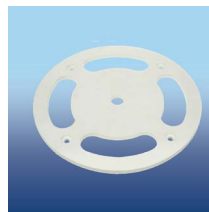

▲ High thickness synthetic rubber gasket

OPTIONAL ACCESSORIES



▲ V9500 Mount



▲ V9804NTWIN twin radome



Mars 4 "Neo"

60cm (24") dish diameter, wireless controlled, 1/16 outputs

Category: SAT TV

Subcategories: Marine Antennas

Code: V9804N



🇮🇹 Mars 4 "NEO" is the new FULL-HD / 4K wirelessly controlled satellite TV antenna with 60cm dish to use up to 16 TVs simultaneously. Like all Glomex "NEO" satellite TV antennas, Mars 4 is equipped with a super fast satellite locking system even in extreme rough sea conditions thanks to totally renewed electronics and mechanics: more powerful processor, faster driver and more robust. Furthermore, the new electronics have been designed to have extremely quiet satellite TV antennas, both in the satellite search phase and in the tracking phase. Thanks to the introduction of a brand new GPS system, the new "NEO" satellite TV antennas save the previous the navigation positions and guarantee increased signal reception performance even at the edges of the signal coverage area. Mars 4 "NEO" is managed through the free Glomex SAT TV App available for iOS and Android devices.

By downloading the app, you can manage the "NEO" satellite TV antennas in one click via Bluetooth® with your own smartphone/tablet and:

- ▶ update the satellites list
- ▶ update the antenna
- ▶ select and change satellites
- ▶ send the operating parameters of the antenna to technical assistance in case of need

Supplied accessories:

- ▶ 12/24 Vdc control unit.
- ▶ 10m (33') coaxial cable.
- ▶ 1,5m (5') coaxial cable.
- ▶ High thickness synthetic rubber gasket.

TECHNOLOGY	DVB-S2 4K FULL HD
DISH DIAMETER	600 mm (24")
RADOME DIMENSIONS	600×660 mm (26×26")
LNB	Universal single
APP	yes
COAX CABLE	4
RECEIVER OUTPUT	1/16
WEIGHT	16 kg (35,3 lb)
TRACKING	50° sec
GAIN	36,5 dB (12 GHz)
SKEW	Manual
DISH TYPE	Prime Focus + HPD
POLARIZATION	Linear (H + V)
LNB FREQUENCY RANGE	10,7 – 12,75 GHz LNB universal
RADOME TYPE	U.V. resistant
POWER REQUIREMENT	12 Vdc
OPERATING TEMPERATURE RANGE	-20° +55°
AZIMUTH	Unlimited
ELEVATION	5° / 90°
TYPE OF STABILIZATION	gyro on 2 axis + 3° axis by interpolation
SATELLITE IDENTIFICATION	NIT (Network Information Table)
MIN EIRP	47 dBW
FUTURE UPGRADES READY	yes
CONTROL UNIT	unlimited

More info on www.glomex.it

🇮🇹 Mars 4 "NEO" est la nouvelle antenne TV satellite FULL-HD / 4K contrôlée sans fil avec un disque de 60 cm pour utiliser jusqu'à 16 téléviseurs simultanément. Comme toutes les antennes de télévision par satellite Glomex "NEO", Mars 4 est équipé d'un système de verrouillage par satellite ultra-rapide même dans des conditions de mer extrêmement agitée grâce à une électronique et une mécanique totalement renouvelées: processeur plus puissant, pilote plus rapide et plus robuste. En outre, la nouvelle électronique a été conçue pour avoir des antennes de télévision par satellite extrêmement silencieuses, à la fois dans la phase de recherche satellite et dans la phase de poursuite. Grâce à l'introduction d'un tout nouveau système GPS, les nouvelles antennes de télévision par satellite "NEO" mémorisent les positions de navigation précédemment parcourues et garantissent des performances accrues de réception du signal, même en bordure de la zone de couverture du signal. Mars 4 "NEO" est géré via l'application gratuite Glomex SAT TV disponible pour les appareils iOS et Android.

En téléchargeant l'application, vous pouvez vous connecter à l'antenne TV satellite via Bluetooth® en un seul clic:

- ▶ mettre à jour l'antenne.
- ▶ mettre à jour la liste des satellites d'antenne.
- ▶ sélectionner et modifier les satellites.
- ▶ envoyer les paramètres de fonctionnement de l'antenne à l'assistance technique en cas de besoin.

Supplied accessories:

- ▶ control unit 12/24 Vdc.
- ▶ 10 M (33') coaxial cable.
- ▶ 1,5 M (5') coaxial cable.
- ▶ High thickness synthetic rubber gasket

🇮🇹 Mars 4 "NEO" è la nuova antenna TV satellitare FULL-HD/4K a controllo wireless con disco da 60cm per utilizzare massimo 16 TV contemporaneamente. Come tutte le antenne TV satellitari Glomex "NEO", Mars 4 è dotata di un sistema super veloce di aggancio del satellite anche in condizioni estreme di mare mosso grazie ad una elettronica e meccanica totalmente rinnovate: processore più potente, driver più veloce e struttura più robusta. Inoltre, la nuova elettronica è stata progettata per avere delle antenne TV satellitari estremamente silenziose, sia in fase di ricerca del satellite sia in fase di tracking. Grazie all'introduzione di un nuovissimo sistema GPS, le nuove antenne TV satellitari "NEO" memorizzano le posizioni di navigazione precedentemente percorse e garantiscono prestazioni di ricezione del segnale incrementate anche ai margini dell'area di copertura del segnale. Mars 4 "NEO" è gestita tramite l'App gratuita Glomex SAT TV disponibile per i dispositivi iOS e Android.

Scaricando l'App è possibile collegarsi all'antenna TV satellitare tramite Bluetooth® e con un solo clic:

- ▶ aggiornare l'antenna.
- ▶ aggiornare l'elenco dei satelliti dell'antenna.
- ▶ selezionare e cambiare i satelliti.
- ▶ inviare i parametri operativi dell'antenna all'assistenza tecnica in caso di necessità.

Prodotti inclusi con l'antenna:

- ▶ Unità di controllo 12/24 Vdc.
- ▶ Cavo coassiale da 10m.
- ▶ Cavo coassiale da 1,5m.
- ▶ Guarnizione in gomma.

SUPPLIED ACCESSORIES



▲ 12/24Vdc control unit



▲ 4 x 10m (33') coax cables



▲ 1,5m (5') coaxial cable



▲ High thickness synthetic rubber gasket

OPTIONAL ACCESSORIES



▲ V9500 mount



▲ V9804NTWIN twin radome



Mars 4 dCSS "Neo"

60cm (24") dish diameter, wireless controlled, only 1 decoder for 1/16 outputs

Category: SAT TV

Subcategories: dCSS Marine Antennas

Code: V9804N/DCSS



🇮🇹 Mars 4 "NEO" DCSS is the new FULL-HD / 4K wirelessly controlled satellite TV antenna with 60cm disc to use up to 16 TVs simultaneously. Developed with the dCSS / SCR technology, Mars 4 "NEO" DCSS has been specially manufactured to be used with the dCSS decoders, for example the Sky Q decoders, and to exploit all their features (such as recording a program while watching a other channel). The dCSS technology also has the great advantage of making installation extremely simple and fast thanks to a single cable that comes down from the antenna even for multi-output installations. Like all Glomex "NEO" satellite TV antennas, Mars 4 is equipped with a super fast satellite locking system even in extreme rough sea conditions thanks to totally renewed electronics and mechanics: more powerful processor, faster driver and more robust. Furthermore, the new electronics have been designed to have extremely quiet satellite TV antennas, both in the satellite search phase and in the tracking phase. Thanks to the introduction of a brand new GPS system, the new "NEO" satellite TV antennas save the previous the navigation positions and guarantee increased signal reception performance even at the edges of the signal coverage area. Mars 4 "NEO" is managed through the free Glomex SAT TV App available for iOS and Android devices.

By downloading the app, you can manage the "NEO" satellite TV antennas in one click via Bluetooth® with your own smartphone/tablet and:

- ▶ update the satellites list
- ▶ update the antenna
- ▶ select and change satellites
- ▶ send the operating parameters of the antenna to technical assistance in case of need

Supplied accessories:

- ▶ 12/24 Vdc control unit.
- ▶ 10m (33') coaxial cable.
- ▶ 1,5m (5') coaxial cable.
- ▶ High thickness synthetic rubber gasket.

TECHNOLOGY	DVB-S2 4K FULL HD
DISH DIAMETER	600 mm (24")
RADOME DIMENSIONS	600×660 mm (26×26")
LNB	Universal single
APP	yes
COAX CABLE	1
RECEIVER OUTPUT	1/16
WEIGHT	16 kg (35,3 lb)
TRACKING	50° sec
GAIN	36,5 dB (12 GHz)
SKEW	Manual
DISH TYPE	Prime Focus + HPD
POLARIZATION	Linear (H + V)
LNB FREQUENCY RANGE	10,7 – 12,75 GHz LNB universal
RADOME TYPE	U.V. resistant
POWER REQUIREMENT	12 Vdc
OPERATING TEMPERATURE RANGE	-20° +55°
AZIMUTH	Unlimited
ELEVATION	5° / 90°
TYPE OF STABILIZATION	gyro on 2 axis + 3° axis by interpolation
SATELLITE IDENTIFICATION	NIT (Network Information Table)
MIN EIRP	47 dBW
FUTURE UPGRADES READY	yes
CONTROL UNIT	unlimited

More info on www.glomex.it

Mars 4 "NEO" DCSS est la nouvelle antenne TV satellite FULL-HD / 4K contrôlée sans fil avec un disque de 60 cm pour utiliser jusqu'à 16 téléviseurs simultanément. Avec la technologie dCSS / SCR, Mars 4 "NEO" DCSS est été spécialement développée pour être utilisée avec les nouveaux décodeurs dCSS, par exemple les décodeurs Sky Q, et pour exploiter toutes leurs fonctionnalités (comme l'enregistrement d'un programme tout en regardant un autre canal). La technologie dCSS présente également le grand avantage de rendre l'installation extrêmement simple et rapide grâce à un seul câble qui descend de l'antenne même pour les installations multi-sorties. Comme toutes les antennes de télévision par satellite Glomex "NEO", Mars 4 est équipé d'un système de verrouillage par satellite ultra-rapide même dans des conditions de mer extrêmement agitée grâce à une électronique et une mécanique totalement renouvelées: processeur plus puissant, pilote plus rapide et plus robuste. En outre, la nouvelle électronique a été conçue pour avoir des antennes de télévision par satellite extrêmement silencieuses, à la fois dans la phase de recherche satellite et dans la phase de poursuite. Grâce à l'introduction d'un tout nouveau système GPS, les nouvelles antennes de télévision par satellite "NEO" mémorisent les positions de navigation précédemment parcourues et garantissent des performances accrues de réception du signal, même en bordure de la zone de couverture du signal. Les modèles d'antenne dotés de la nouvelle Mars 4 "NEO" est géré via l'application gratuite Glomex SAT TV disponible pour les appareils iOS et Android.

En téléchargeant l'application, vous pouvez vous connecter à l'antenne TV satellite via Bluetooth® en un seul clic:

- ▶ mettre à jour l'antenne.
- ▶ mettre à jour la liste des satellites d'antenne.
- ▶ sélectionner et modifier les satellites.
- ▶ envoyer les paramètres de fonctionnement de l'antenne à l'assistance technique en cas de besoin.

Accessoires inclus:

- ▶ control unit 12/24 Vdc.
- ▶ Câble coaxial 10m.
- ▶ Câble coaxial 1,5m.
- ▶ Joint en gomme synthétique

Mars 4 "NEO" DCSS è la nuova antenna TV satellitare FULL-HD/4K a controllo wireless con disco da 60cm per utilizzare massimo 16 TV contemporaneamente. Questa versione è stata sviluppata per i decoder dCSS, ad esempio i decoder Sky Q, e per sfruttarne tutte le loro funzionalità (come la registrazione di un programma in contemporanea alla visione di un altro canale). La tecnologia dCSS inoltre ha il grande vantaggio di rendere l'installazione estremamente semplice e veloce grazie ad un unico cavo che scende dall'antenna anche per le installazioni a multi-uscita. Come tutte le antenne TV satellitari Glomex "NEO", Mars 4 è dotata di un sistema super veloce di aggancio del satellite anche in condizioni estreme di mare mosso grazie ad una elettronica e meccanica totalmente rinnovate: processore più potente, driver più veloce e struttura più robusta. Inoltre, la nuova elettronica è stata progettata per avere delle antenne TV satellitari estremamente silenziose, sia in fase di ricerca del satellite sia in fase di tracking. Grazie all'introduzione di un nuovissimo sistema GPS, le nuove antenne TV satellitari "NEO" memorizzano le posizioni di navigazione precedentemente percorse e garantiscono prestazioni di ricezione del segnale incrementate anche ai margini dell'area di copertura del segnale. Mars 4 "NEO" è gestita tramite l'App gratuita Glomex SAT TV disponibile per i dispositivi iOS e Android.

Scaricando l'App è possibile collegarsi all'antenna TV satellitare tramite Bluetooth® e con un solo clic:

- ▶ aggiornare l'antenna.
- ▶ aggiornare l'elenco dei satelliti dell'antenna.
- ▶ selezionare e cambiare i satelliti.
- ▶ inviare i parametri operativi dell'antenna all'assistenza tecnica in caso di necessità.

Prodotti inclusi con l'antenna:

- ▶ unita' di controllo 12/24 Vdc.
- ▶ Cavo coassiale da 10m.
- ▶ Cavo coassiale da 1,5m.
- ▶ Guarnizione in gomma.

SUPPLIED ACCESSORIES



▲ 12/24Vdc control unit



▲ 10m (33') coax cable



▲ 1,5m (5') coaxial cable



▲ High thickness synthetic rubber gasket

OPTIONAL ACCESSORIES



▲ V9500 mount



▲ V9804NTWIN twin radome



Mars 4 SKEW "Neo"

60cm (24") dish diameter, wireless controlled, 1/16 outputs - automatic skew

Category: SAT TV

Subcategories: Marine Antennas

Code: V9804NSKEW



MADE IN ITALY



Mars 4 "NEO" is the new FULL-HD / 4K wireless controlled satellite TV antenna with 60cm dish to use up to 16 TVs simultaneously. The automatic skew is a compensation system proposed by Glomex which, acknowledging the geographic position, acts directly on the LNB by changing automatically the inclination. In this way the polarization is optimized and the best possible signal quality is achieved. Like all Glomex "NEO" satellite TV antennas, Mars 4 is equipped with a super fast satellite locking system even in extreme rough sea conditions thanks to totally renewed electronics and mechanics: more powerful processor, faster driver and more robust. Furthermore, the new electronics have been designed to have extremely quiet satellite TV antennas, both in the satellite search phase and in the tracking phase. Thanks to the introduction of a brand new GPS system, the new "NEO" satellite TV antennas save the previous the navigation positions and guarantee increased signal reception performance even at the edges of the signal coverage area. Mars 4 "NEO" is managed through the free Glomex SAT TV App available for iOS and Android devices.

By downloading the app, you can manage the "NEO" satellite TV antennas in one click via Bluetooth® with your own smartphone/tablet and:

- ▶ update the satellites list
- ▶ update the antenna
- ▶ select and change satellites
- ▶ send the operating parameters of the antenna to technical assistance in case of need

Supplied accessories:

- ▶ 12/24 Vdc control unit.
- ▶ 10m (33') coaxial cable.
- ▶ 1,5m (5') coaxial cable.
- ▶ High thickness synthetic rubber gasket.

TECHNOLOGY	DVB-S2 4K FULL HD
DISH DIAMETER	600 mm (24")
RADOME DIMENSIONS	600×660 mm (26×26")
LNB	Universal single
APP	yes
COAX CABLE	4
RECEIVER OUTPUT	1/16
WEIGHT	16 kg (35,3 lb)
TRACKING	50° sec
GAIN	36,5 dB (12 GHz)
SKEW	Automatic
DISH TYPE	Prime Focus + HPD
POLARIZATION	Linear (H + V)
LNB FREQUENCY RANGE	10,7 – 12,75 GHz LNB universal
RADOME TYPE	U.V. resistant
POWER REQUIREMENT	12 Vdc
OPERATING TEMPERATURE RANGE	-20° +55°
AZIMUTH	Unlimited
ELEVATION	5° / 90°
TYPE OF STABILIZATION	gyro on 2 axis + 3° axis by interpolation
SATELLITE IDENTIFICATION	NIT (Network Information Table)
MIN EIRP	47 dBW
FUTURE UPGRADES READY	yes
CONTROL UNIT	unlimited

More info on www.glomex.it

🇫🇷 Mars 4 "NEO" SKEW est la nouvelle antenne TV satellite FULL-HD / 4K contrôlée sans fil avec un disque de 47 cm pour utiliser jusqu'à 16 téléviseurs simultanément. Elle est fournie avec le skew automatique. Le skew automatique est un système de compensation proposé par Glomex qui reconnaît la position géographique et agit physiquement sur la LNB en modifiant automatiquement l'inclinaison. De cette façon, on optimise la polarisation pour obtenir la meilleure qualité possible du signal. Comme toutes les antennes de télévision par satellite Glomex "NEO", Mars 4 est équipé d'un système de verrouillage par satellite ultra-rapide même dans des conditions de mer extrêmement agitée grâce à une électronique et une mécanique totalement renouvelées: processeur plus puissant, pilote plus rapide et plus robuste. En outre, la nouvelle électronique a été conçue pour avoir des antennes de télévision par satellite extrêmement silencieuses, à la fois dans la phase de recherche satellite et dans la phase de poursuite. Grâce à l'introduction d'un tout nouveau système GPS, les nouvelles antennes de télévision par satellite "NEO" mémorisent les positions de navigation précédemment parcourues et garantissent des performances accrues de réception du signal, même en bordure de la zone de couverture du signal. Mars 4 "NEO" est géré via l'application gratuite Glomex SAT TV disponible pour les appareils iOS et Android.

En téléchargeant l'application, vous pouvez vous connecter à l'antenne TV satellite via Bluetooth® en un seul clic:

- ▶ mettre à jour l'antenne.
- ▶ mettre à jour la liste des satellites d'antenne.
- ▶ sélectionner et modifier les satellites.
- ▶ envoyer les paramètres de fonctionnement de l'antenne à l'assistance technique en cas de besoin.

Accessoires inclus:

- ▶ control unit 12/24 Vdc.
- ▶ Câble coaxial 10m.
- ▶ Câble coaxial 1,5m.
- ▶ Joint en gomme synthétique

🇮🇹 Mars 4 "NEO" è la nuova antenna TV satellitare FULL-HD/4K a controllo wireless con disco da 60cm per utilizzare massimo 16 TV contemporaneamente. Lo skew automatico è un sistema di compensazione proposto da Glomex che, in base alla posizione geografica, agisce direttamente sull'LNb modificandone automaticamente l'inclinazione e ottimizzando la polarizzazione per ottenere la migliore qualità possibile del segnale. Come tutte le antenne TV satellitari Glomex "NEO", Mars 4 è dotata di un sistema super veloce di aggancio del satellite anche in condizioni estreme di mare mosso grazie ad una elettronica e meccanica totalmente rinnovate: processore più potente, driver più veloce e struttura più robusta. Inoltre, la nuova elettronica è stata progettata per avere delle antenne TV satellitari estremamente silenziose, sia in fase di ricerca del satellite sia in fase di tracking. Grazie all'introduzione di un nuovissimo sistema GPS, le nuove antenne TV satellitari "NEO" memorizzano le posizioni di navigazione precedentemente percorse e garantiscono prestazioni di ricezione del segnale incrementate anche ai margini dell'area di copertura del segnale. Mars 4 "NEO" è gestita tramite l'App gratuita Glomex SAT TV disponibile per i dispositivi iOS e Android.

Scaricando l'App è possibile collegarsi all'antenna TV satellitare tramite Bluetooth® e con un solo clic:

- ▶ aggiornare l'antenna.
- ▶ aggiornare l'elenco dei satelliti dell'antenna.
- ▶ selezionare e cambiare i satelliti.
- ▶ inviare i parametri operativi dell'antenna all'assistenza tecnica in caso di necessità.

Prodotti inclusi con l'antenna:

- ▶ unita' di controllo 12/24 Vdc.
- ▶ Cavo coassiale da 10m.
- ▶ Cavo coassiale da 1,5m.
- ▶ Guarnizione in gomma.

SUPPLIED ACCESSORIES



▲ 12/24Vdc control unit



▲ 4 x 10m (33') coax cables



▲ 1,5m (5') coaxial cable



▲ High thickness synthetic rubber gasket

OPTIONAL ACCESSORIES



▲ V9500 mount



▲ V9804NTWIN twin radome



Mars 4 SKEW dCSS "Neo"

60cm (24") dish diameter, wireless controlled, only 1 decoder for 1/16 outputs, automatic skew

Category: SAT TV

Subcategories: dCSS Marine Antennas

Code: V9804NSKEW/DCSS



Mars 4 "NEO" DCSS is the new FULL-HD / 4K wirelessly controlled satellite TV antenna with 60cm disc to use up to 16 TVs simultaneously. The automatic skew is a compensation system proposed by Glomex which, acknowledging the geographic position, acts directly on the LNB by changing automatically the inclination. In this way the polarization is optimized and the best possible signal quality is achieved. Developed with the dCSS / SCR technology, Mars 4 "NEO" DCSS has been specially manufactured to be used with the dCSS decoders, for example the Sky Q decoders, and to exploit all their features (such as recording a program while watching a other channel). The dCSS technology also has the great advantage of making installation extremely simple and fast thanks to a single cable that comes down from the antenna even for multi-output installations. Like all Glomex "NEO" satellite TV antennas, Mars 4 is equipped with a super fast satellite locking system even in extreme rough sea conditions thanks to totally renewed electronics and mechanics: more powerful processor, faster driver and more robust. Furthermore, the new electronics have been designed to have extremely quiet satellite TV antennas, both in the satellite search phase and in the tracking phase. Thanks to the introduction of a brand new GPS system, the new "NEO" satellite TV antennas save the previous the navigation positions and guarantee increased signal reception performance even at the edges of the signal coverage area. Mars 4 "NEO" is managed through the free Glomex SAT TV App available for iOS and Android devices.

By downloading the app, you can manage the "NEO" satellite TV antennas in one click via Bluetooth® with your own smartphone/tablet and:

- ▶ update the satellites list
- ▶ update the antenna
- ▶ select and change satellites
- ▶ send the operating parameters of the antenna to technical assistance in case of need

TECHNOLOGY	DVB-S2 4K FULL HD
DISH DIAMETER	600 mm (24")
RADOME DIMENSIONS	600x660 mm (26x26")
LNB	Universal single
APP	yes
COAX CABLE	1
RECEIVER OUTPUT	1/16
WEIGHT	16 kg (35,3 lb)
TRACKING	50° sec
GAIN	36,5 dB (12 GHz)
SKEW	Automatic
DISH TYPE	Prime Focus + HPD
POLARIZATION	Linear (H + V)
LNB FREQUENCY RANGE	10,7 – 12,75 GHz LNB universal
RADOME TYPE	U.V. resistant
POWER REQUIREMENT	12 Vdc
OPERATING TEMPERATURE RANGE	-20° +55°
AZIMUTH	Unlimited
ELEVATION	5° / 90°
TYPE OF STABILIZATION	gyro on 2 axis + 3° axis by interpolation
SATELLITE IDENTIFICATION	NIT (Network Information Table)
MIN EIRP	47 dBW
FUTURE UPGRADES READY	yes
CONTROL UNIT	unlimited

More info on www.glomex.it

Supplied accessories:

- ▶ 12/24 Vdc control unit.
- ▶ 10m (33') coaxial cable.
- ▶ 1,5m (5') coaxial cable.
- ▶ High thickness synthetic rubber gasket

🇮🇹 Mars 4 "NEO" DCSS SKEW est la nouvelle antenne TV satellite FULL-HD / 4K contrôlée sans fil avec un disque de 60 cm pour utiliser jusqu'à 16 téléviseurs simultanément. Elle est fournie avec le skew automatique. Le skew automatique est un système de compensation proposé par Glomex qui reconnaît la position géographique et agit physiquement sur la LNB en modifiant automatiquement l'inclinaison. De cette façon, on optimise la polarisation pour obtenir la meilleure qualité possible du signal. En plus, avec la technologie dCSS / SCR, Mars 4 "NEO" DCSS est été spécialement développée pour être utilisée avec les nouveaux décodeurs dCSS, par exemple les décodeurs Sky Q, et pour exploiter toutes leurs fonctionnalités (comme l'enregistrement d'un programme tout en regardant un autre canal). La technologie dCSS présente également le grand avantage de rendre l'installation extrêmement simple et rapide grâce à un seul câble qui descend de l'antenne même pour les installations multi-sorties. Comme toutes les antennes de télévision par satellite Glomex "NEO", Mars 4 est équipé d'un système de verrouillage par satellite ultra-rapide même dans des conditions de mer extrêmement agitée grâce à une électronique et une mécanique totalement renouvelées: processeur plus puissant, pilote plus rapide et plus robuste. En outre, la nouvelle électronique a été conçue pour avoir des antennes de télévision par satellite extrêmement silencieuses, à la fois dans la phase de recherche satellite et dans la phase de poursuite. Grâce à l'introduction d'un tout nouveau système GPS, les nouvelles antennes de télévision par satellite "NEO" mémorisent les positions de navigation précédemment parcourues et garantissent des performances accrues de réception du signal, même en bordure de la zone de couverture du signal. Les modèles d'antenne dotés de la nouvelle Mars 4 "NEO" est géré via l'application gratuite Glomex SAT TV disponible pour les appareils iOS et Android.

En téléchargeant l'application, vous pouvez vous connecter à l'antenne TV satellite via Bluetooth® en un seul clic:

- ▶ mettre à jour l'antenne.
- ▶ mettre à jour la liste des satellites d'antenne.
- ▶ sélectionner et modifier les satellites.
- ▶ envoyer les paramètres de fonctionnement de l'antenne à l'assistance technique en cas de besoin.

Accessoires inclus:

- ▶ control unit 12/24 Vdc.
- ▶ Câble coaxial 10m.
- ▶ Câble coaxial 1,5m.
- ▶ Joint en gomme synthétique

🇮🇹 Mars 4 "NEO" è la nuova antenna TV satellitare FULL-HD/4K a controllo wireless con disco da 60cm per utilizzare massimo 16 TV contemporaneamente. Lo skew automatico è un sistema di compensazione proposto da Glomex che, in base alla posizione geografica, agisce direttamente sull'LNB modificandone automaticamente l'inclinazione e ottimizzando la polarizzazione per ottenere la migliore qualità possibile del segnale. Come tutte le antenne TV satellitari Glomex "NEO", Mars 4 è dotata di un sistema super veloce di aggancio del satellite anche in condizioni estreme di mare mosso grazie ad una elettronica e meccanica totalmente rinnovate: processore più potente, driver più veloce e struttura più robusta. Inoltre, la nuova elettronica è stata progettata per avere delle antenne TV satellitari estremamente silenziose, sia in fase di ricerca del satellite sia in fase di tracking. Grazie all'introduzione di un nuovissimo sistema GPS, le nuove antenne TV satellitari "NEO" memorizzano le posizioni di navigazione precedentemente percorse e garantiscono prestazioni di ricezione del segnale incrementate anche ai margini dell'area di copertura del segnale. Mars 4 "NEO" è gestita tramite l'App gratuita Glomex SAT TV disponibile per i dispositivi iOS e Android.

Scaricando l'App è possibile collegarsi all'antenna TV satellitare tramite Bluetooth® e con un solo clic:

- ▶ aggiornare l'antenna.
- ▶ aggiornare l'elenco dei satelliti dell'antenna.
- ▶ selezionare e cambiare i satelliti.
- ▶ inviare i parametri operativi dell'antenna all'assistenza tecnica in caso di necessità.

Prodotti inclusi con l'antenna:

- ▶ Unita' di controllo 12/24 Vdc.
- ▶ Cavo coassiale da 10m.
- ▶ Cavo coassiale da 1,5m.
- ▶ Guarnizione in gomma.

SUPPLIED ACCESSORIES



▲ 12/24Vdc control unit



▲ 10m (33') coax cable



▲ 1,5m (5') coaxial cable



▲ High thickness synthetic rubber gasket

OPTIONAL ACCESSORIES



▲ V9500 mount



▲ V9804NTWIN twin radome



Danube "Neo"

58x32cm (23x13") dish diameter, wireless controlled, 1 output, for river boats

Category: SAT TV

Subcategories: River Antennas

Code: R500N



MADE IN ITALY



🇮🇹 Danube "NEO" is the new FULL-HD / 4K wirelessly controlled satellite TV antenna for river boats with 58x32cm dish and 1 decoder output. Like all Glomex "NEO" satellite TV antennas, Danube "NEO" is equipped with a super fast satellite locking system even in extreme rough sea conditions thanks to totally renewed electronics and mechanics: more powerful processor, faster driver and more robust. Furthermore, the new electronics have been designed to have extremely quiet satellite TV antennas, both in the satellite search phase and in the tracking phase. Thanks to the introduction of a brand new GPS system, the new "NEO" satellite TV antennas save the previous the navigation positions and guarantee increased signal reception performance even at the edges of the signal coverage area. Danube "NEO" is managed through the free Glomex SAT TV App available for iOS and Android devices.

By downloading the app, you can manage the "NEO" satellite TV antennas in one click via Bluetooth® with your own smartphone/tablet and:

- ▶ update the satellites list
- ▶ update the antenna
- ▶ select and change satellites
- ▶ send the operating parameters of the antenna to technical assistance in case of need.

Supplied accessories:

- ▶ 12/24 Vdc control unit.
- ▶ 10m (33') coaxial cable.
- ▶ 1,5m (5') coaxial cable.
- ▶ High thickness synthetic rubber gasket.

TECHNOLOGY	DVB-S2 4K FULL HD
DISH DIAMETER	580x320 mm (23x13") (b x h)
RADOME DIMENSIONS	660x390 mm (26x15")
LNB	Universal single
APP	yes
COAX CABLE	1
RECEIVER OUTPUT	1
WEIGHT	8 kg (17.6 lb)
TRACKING	AZ 25° sec / EL 25° sec
GAIN	35 dB (12 GHz)
SKEW	Manual
DISH TYPE	Prime Focus + HPD
POLARIZATION	Linear (H + V)
LNB FREQUENCY RANGE	10,7 – 12,75 GHz LNB universal
RADOME TYPE	U.V. resistant
POWER REQUIREMENT	12 Vdc
OPERATING TEMPERATURE RANGE	-20° +55°
AZIMUTH	Unlimited
ELEVATION	15° / 50°
TYPE OF STABILIZATION	gyro on 2 axis + 3° axis by interpolation
SATELLITE IDENTIFICATION	NIT (Network Information Table)
MIN EIRP	48 dBW
FUTURE UPGRADES READY	yes
CONTROL UNIT	unlimited

More info on www.glomex.it

🇮🇹 Danube "NEO" est la nouvelle antenne TV satellite FULL-HD / 4K contrôlée sans fil pour bateaux fluviaux, avec un disque de 58x32 cm avec une sortie pour decodeur. Comme toutes les antennes de télévision par satellite Glomex "NEO", Danube "NEO" est équipé d'un système de verrouillage par satellite ultra-rapide même dans des conditions de mer extrêmement agitée grâce à une électronique et une mécanique totalement renouvelées: processeur plus puissant, pilote plus rapide et plus robuste. En outre, la nouvelle électronique a été conçue pour avoir des antennes de télévision par satellite extrêmement silencieuses, à la fois dans la phase de recherche satellite et dans la phase de poursuite. Grâce à l'introduction d'un tout nouveau système GPS, les nouvelles antennes de télévision par satellite "NEO" mémorisent les positions de navigation précédemment parcourues et garantissent des performances accrues de réception du signal, même en bordure de la zone de couverture du signal. Danube "NEO" est géré via l'application gratuite Glomex SAT TV disponible pour les appareils iOS et Android.

En téléchargeant l'application, vous pouvez vous connecter à l'antenne TV satellite via Bluetooth® en un seul clic:

- ▶ mettre à jour l'antenne.
- ▶ mettre à jour la liste des satellites d'antenne.
- ▶ sélectionner et modifier les satellites.
- ▶ envoyer les paramètres de fonctionnement de l'antenne à l'assistance.
- ▶ technique en cas de besoin.

Supplied accessories:

- ▶ Control unit 12 Vdc.
- ▶ 10 M (33') coaxial cable.
- ▶ 1,5 M (5') coaxial cable.
- ▶ High thickness synthetic rubber gasket

🇮🇹 Danube "NEO" è la nuova antenna TV satellitare FULL-HD/4K per barche da fiume a controllo wireless con disco da 50x32cm con una uscita per decoder. Come tutte le antenne TV satellitari Glomex "NEO", Danube "NEO" è dotata di un sistema super veloce di aggancio del satellite anche in condizioni estreme di mare mosso grazie ad una elettronica e meccanica totalmente rinnovate: processore più potente, driver più veloce e struttura più robusta. Inoltre, la nuova elettronica è stata progettata per avere delle antenne TV satellitari estremamente silenziose, sia in fase di ricerca del satellite sia in fase di tracking. Grazie all'introduzione di un nuovissimo sistema GPS, le nuove antenne TV satellitari "NEO" memorizzano le posizioni di navigazione precedentemente percorse e garantiscono prestazioni di ricezione del segnale incrementate anche ai margini dell'area di copertura del segnale. Danube "NEO" è gestita tramite l'App gratuita Glomex SAT TV disponibile per i dispositivi iOS e Android.

Scaricando l'App è possibile collegarsi all'antenna TV satellitare tramite Bluetooth® e con un solo clic:

- ▶ aggiornare l'antenna.
- ▶ aggiornare l'elenco dei satelliti dell'antenna.
- ▶ selezionare e cambiare i satelliti.
- ▶ inviare i parametri operativi dell'antenna all'assistenza tecnica in caso di necessità.

Prodotti inclusi con l'antenna:

- ▶ Unita' di controllo 12 Vdc.
- ▶ Cavo coassiale da 10m.
- ▶ Cavo coassiale da 1,5m.
- ▶ Guarnizione in gomma.

SUPPLIED ACCESSORIES



▲ 12/24Vdc control unit



▲ 10m (33') coax cable



▲ 1,5m (5') coaxial cable



▲ High thickness synthetic rubber gasket

OPTIONAL ACCESSORIES



▲ R500NTWIN twin radome



🇮🇹 Danube “NEO” DCSS is the new FULL-HD / 4K wirelessly controlled satellite TV antenna for river boats with 58x32cm disc to use up to 16 TVs simultaneously. Developed with the dCSS / SCR technology, Danube “NEO” DCSS has been specially manufactured to be used with the dCSS decoders, for example the Sky Q decoders, and to exploit all their features (such as recording a program while watching a other channel). The dCSS technology also has the great advantage of making installation extremely simple and fast thanks to a single cable that comes down from the antenna even for multi-output installations. Like all Glomex “NEO” satellite TV antennas, Danube is equipped with a super fast satellite locking system even in extreme rough sea conditions thanks to totally renewed electronics and mechanics: more powerful processor, faster driver and more robust. Furthermore, the new electronics have been designed to have extremely quiet satellite TV antennas, both in the satellite search phase and in the tracking phase. Thanks to the introduction of a brand new GPS system, the new “NEO” satellite TV antennas save the previous the navigation positions and guarantee increased signal reception performance even at the edges of the signal coverage area. Danube “NEO” is managed through the free Glomex SAT TV App available for iOS and Android devices.

By downloading the app, you can manage the “NEO” satellite TV antennas in one click via Bluetooth® with your own smartphone/tablet and:

- ▶ update the satellites list
- ▶ update the antenna
- ▶ select and change satellites
- ▶ send the operating parameters of the antenna to technical assistance in case of need.

Danube dCSS “Neo”

58x32cm (23x13”) dish diameter, wireless controlled, only 1 cable for 1/16 outputs, for river boats

Category: SAT TV

Subcategories: dCSS River Antennas

Code: R500N/DCSS



TECHNOLOGY	DVB-S2 4K FULL HD
DISH DIAMETER	580x320 mm (23x13”) (bxh)
RADOME DIMENSIONS	660x390 mm (26x15”)
LNB	Universal single
APP	yes
COAX CABLE	1
RECEIVER OUTPUT	1/16
WEIGHT	8 kg (17.6 lb)
TRACKING	AZ 25° sec / EL 25° sec
GAIN	35 dB (12 GHz)
SKEW	Manual
DISH TYPE	Prime Focus + HPD
POLARIZATION	Linear (H + V)
LNB FREQUENCY RANGE	10,7 – 12,75 GHz LNB universal
RADOME TYPE	U.V. resistant
POWER REQUIREMENT	12 Vdc
OPERATING TEMPERATURE RANGE	-20° +55°
AZIMUTH	Unlimited
ELEVATION	15° / 50°
TYPE OF STABILIZATION	gyro on 2 axis + 3° axis by interpolation
SATELLITE IDENTIFICATION	NIT (Network Information Table)
MIN EIRP	48 dBW
FUTURE UPGRADES READY	yes
CONTROL UNIT	unlimited
<i>More info on www.glomex.it</i>	

Supplied accessories:

- ▶ 12/24 Vdc control unit.
- ▶ 10m (33’) coaxial cable.
- ▶ 1,5m (5’) coaxial cable.
- ▶ High thickness synthetic rubber gasket.

D Danube "NEO" DCSS est la nouvelle antenne TV satellite FULL-HD / 4K contrôlée sans fil pour bateaux fluviaux avec un disque de 58x32 cm pour utiliser jusqu'à 16 téléviseurs simultanément. Avec la technologie dCSS / SCR, Danube "NEO" DCSS est été spécialement développée pour être utilisée avec les nouveaux décodeurs dCSS, par exemple les décodeurs Sky Q, et pour exploiter toutes leurs fonctionnalités (comme l'enregistrement d'un programme tout en regardant un autre canal). La technologie dCSS présente également le grand avantage de rendre l'installation extrêmement simple et rapide grâce à un seul câble qui descend de l'antenne même pour les installations multi-sorties. Comme toutes les antennes de télévision par satellite Glomex "NEO", Danube est équipé d'un système de verrouillage par satellite ultra-rapide même dans des conditions de mer extrêmement agitée grâce à une électronique et une mécanique totalement renouvelées: processeur plus puissant, pilote plus rapide et plus robuste. En outre, la nouvelle électronique a été conçue pour avoir des antennes de télévision par satellite extrêmement silencieuses, à la fois dans la phase de recherche satellite et dans la phase de poursuite. Grâce à l'introduction d'un tout nouveau système GPS, les nouvelles antennes de télévision par satellite "NEO" mémorisent les positions de navigation précédemment parcourues et garantissent des performances accrues de réception du signal, même en bordure de la zone de couverture du signal. Les modèles d'antenne dotés de la nouvelle Danube "NEO" est géré via l'application gratuite Glomex SAT TV disponible pour les appareils iOS et Android.

En téléchargeant l'application, vous pouvez vous connecter à l'antenne TV satellite via Bluetooth® en un seul clic:

- ▶ mettre à jour l'antenne
- ▶ mettre à jour la liste des satellites d'antenne
- ▶ sélectionner et modifier les satellites.
- ▶ envoyer les paramètres de fonctionnement de l'antenne à l'assistance technique en cas de besoin.

Accessoires inclus:

- ▶ control unit 12 Vdc.
- ▶ Câble coaxial 10m.
- ▶ Câble coaxial 1,5m.
- ▶ Joint en gomme synthétique

D Danube "NEO" DCSS è la nuova antenna TV satellitare FULL-HD/4K a controllo wireless per barche da fiume con disco da 58x32cm per utilizzare massimo 16 TV contemporaneamente. Questa versione è stata sviluppata per i decoder dCSS, ad esempio i decoder Sky Q, e per sfruttarne tutte le loro funzionalità (come la registrazione di un programma in contemporanea alla visione di un altro canale). La tecnologia dCSS inoltre ha il grande vantaggio di rendere l'installazione estremamente semplice e veloce grazie ad un unico cavo che scende dall'antenna anche per le installazioni a multi-uscita. Come tutte le antenne TV satellitari Glomex "NEO", Danube "NEO" è dotata di un sistema super veloce di aggancio del satellite anche in condizioni estreme di mare mosso grazie ad una elettronica e meccanica totalmente rinnovate: processore più potente, driver più veloce e struttura più robusta. Inoltre, la nuova elettronica è stata progettata per avere delle antenne TV satellitari estremamente silenziose, sia in fase di ricerca del satellite sia in fase di tracking. Grazie all'introduzione di un nuovissimo sistema GPS, le nuove antenne TV satellitari "NEO" memorizzano le posizioni di navigazione precedentemente percorse e garantiscono prestazioni di ricezione del segnale incrementate anche ai margini dell'area di copertura del segnale. Danube "NEO" è gestita tramite l'App gratuita Glomex SAT TV disponibile per i dispositivi iOS e Android.

Scaricando l'App è possibile collegarsi all'antenna TV satellitare tramite Bluetooth® e con un solo clic:

- ▶ aggiornare l'antenna.
- ▶ aggiornare l'elenco dei satelliti dell'antenna.
- ▶ selezionare e cambiare i satelliti.
- ▶ inviare i parametri operativi dell'antenna all'assistenza tecnica in caso di necessità.

Prodotti inclusi con l'antenna:

- ▶ unita' di controllo 12 Vdc.
- ▶ Cavo coassiale da 10m.
- ▶ Cavo coassiale da 1,5m.
- ▶ Guarnizione in gomma.

SUPPLIED ACCESSORIES



▲ 12/24Vdc control unit



▲ 10m (33') coax cable



▲ 1,5m (5') coaxial cable



▲ High thickness synthetic rubber gasket

OPTIONAL ACCESSORIES



▲ R500NTWIN twin radome



Rhine "Neo"

60cm (24") dish diameter, wireless controlled, 1 output, for river boats

Category: SAT TV

Subcategories: River Antennas

Code: R9801N



MADE IN ITALY



River "NEO" is the new FULL-HD / 4K wirelessly controlled satellite TV antenna for river boats with 60cm dish with 1 decoder output. Like all Glomex "NEO" satellite TV antennas, Mars "NEO" is equipped with a super fast satellite locking system even in extreme rough sea conditions thanks to totally renewed electronics and mechanics: more powerful processor, faster driver and more robust. Furthermore, the new electronics have been designed to have extremely quiet satellite TV antennas, both in the satellite search phase and in the tracking phase. Thanks to the introduction of a brand new GPS system, the new "NEO" satellite TV antennas save the previous the navigation positions and guarantee increased signal reception performance even at the edges of the signal coverage area. River "NEO" is managed through the free Glomex SAT TV App available for iOS and Android devices.

By downloading the app, you can manage the "NEO" satellite TV antennas in one click via Bluetooth® with your own smartphone/tablet and:

- ▶ update the satellites list
- ▶ update the antenna
- ▶ select and change satellites
- ▶ send the operating parameters of the antenna to technical assistance in case of need.

Supplied accessories:

- ▶ 12/24 Vdc control unit.
- ▶ 10m (33') coaxial cable.
- ▶ 1,5m (5') coaxial cable.
- ▶ High thickness synthetic rubber gasket

TECHNOLOGY	DVB-S2 4K FULL HD
DISH DIAMETER	600 mm (24")
RADOME DIMENSIONS	660x660 mm (26x26")
LNB	Universal single
APP	yes
COAX CABLE	1
RECEIVER OUTPUT	1
WEIGHT	16 kg (35.3 lb)
TRACKING	AZ 25° sec / EL 25° sec
GAIN	36,5 dB (12 GHz)
SKEW	Manual
DISH TYPE	Prime Focus + HPD
POLARIZATION	Linear (H + V)
LNB FREQUENCY RANGE	10,7 – 12,75 GHz LNB universal
RADOME TYPE	U.V. resistant
POWER REQUIREMENT	12 Vdc
OPERATING TEMPERATURE RANGE	-20° +55°
AZIMUTH	Unlimited
ELEVATION	5° / 90°
TYPE OF STABILIZATION	gyro on 2 axis + 3° axis by interpolation
SATELLITE IDENTIFICATION	NIT (Network Information Table)
MIN EIRP	47 dBW
FUTURE UPGRADES READY	yes
CONTROL UNIT	unlimited

More info on www.glomex.it

River "NEO" est la nouvelle antenne TV satellite FULL-HD / 4K contrôlée sans fil pour bateaux fluviaux, avec un disque de 60 cm avec une sortie pour decodeur. Comme toutes les antennes de télévision par satellite Glomex "NEO", River "NEO" est équipé d'un système de verrouillage par satellite ultra-rapide même dans des conditions de mer extrêmement agitée grâce à une électronique et une mécanique totalement renouvelées: processeur plus puissant, pilote plus rapide et plus robuste. En outre, la nouvelle électronique a été conçue pour avoir des antennes de télévision par satellite extrêmement silencieuses, à la fois dans la phase de recherche satellite et dans la phase de poursuite. Grâce à l'introduction d'un tout nouveau système GPS, les nouvelles antennes de télévision par satellite "NEO" mémorisent les positions de navigation précédemment parcourues et garantissent des performances accrues de réception du signal, même en bordure de la zone de couverture du signal. River "NEO" est géré via l'application gratuite Glomex SAT TV disponible pour les appareils iOS et Android.

En téléchargeant l'application, vous pouvez vous connecter à l'antenne TV satellite via Bluetooth® en un seul clic:

- ▶ mettre à jour l'antenne.
- ▶ mettre à jour la liste des satellites d'antenne.
- ▶ sélectionner et modifier les satellites.
- ▶ envoyer les paramètres de fonctionnement de l'antenne à l'assistance technique en cas de besoin.

Accessoires inclus:

- ▶ control unit 12/24 Vdc.
- ▶ Câble coaxial 10m.
- ▶ Câble coaxial 1,5m.
- ▶ Joint en gomme synthétique

River "NEO" è la nuova antenna TV satellitare FULL-HD/4K per barche da fiume a controllo wireless con disco da 60cm con una uscita per decoder. Come tutte le antenne TV satellitari Glomex "NEO", River "NEO" è dotata di un sistema super veloce di aggancio del satellite anche in condizioni estreme di mare mosso grazie ad una elettronica e meccanica totalmente rinnovate: processore più potente, driver più veloce e struttura più robusta. Inoltre, la nuova elettronica è stata progettata per avere delle antenne TV satellitari estremamente silenziose, sia in fase di ricerca del satellite sia in fase di tracking. Grazie all'introduzione di un nuovissimo sistema GPS, le nuove antenne TV satellitari "NEO" memorizzano le posizioni di navigazione precedentemente percorse e garantiscono prestazioni di ricezione del segnale incrementate anche ai margini dell'area di copertura del segnale. River "NEO" è gestita tramite l'App gratuita Glomex SAT TV disponibile per i dispositivi iOS e Android.

Scaricando l'App è possibile collegarsi all'antenna TV satellitare tramite Bluetooth® e con un solo clic:

- ▶ aggiornare l'antenna.
- ▶ aggiornare l'elenco dei satelliti dell'antenna.
- ▶ selezionare e cambiare i satelliti.
- ▶ inviare i parametri operativi dell'antenna all'assistenza tecnica in caso di necessità.

Supplied accessories:

- ▶ control unit 12/24 Vdc.
- ▶ 10 M (33') coaxial cable.
- ▶ 1,5 M (5') coaxial cable.
- ▶ High thickness synthetic rubber gasket.

SUPPLIED ACCESSORIES



▲ 12/24Vdc control unit



▲ 10m (33') coax cable



▲ 1,5m (5') coaxial cable



▲ High thickness synthetic rubber gasket

OPTIONAL ACCESSORIES



▲ V9500 mount



▲ R9801NTWIN



Rhine 4 "Neo"

60cm (24") dish diameter, wireless controlled, 1/16 outputs, for river boats

Category: SAT TV

Subcategories: River Antennas

Code: R9804N



MADE IN ITALY



River 4 "NEO" is the new FULL-HD / 4K wirelessly controlled satellite TV antenna for river boat with 60cm dish to use up to 16 TVs simultaneously. Like all Glomex "NEO" satellite TV antennas, River 4 is equipped with a super fast satellite locking system thanks to totally renewed electronics and mechanics: more powerful processor, faster driver and more robust. Furthermore, the new electronics have been designed to have extremely quiet satellite TV antennas, both in the satellite search phase and in the tracking phase. Thanks to the introduction of a brand new GPS system, the new "NEO" satellite TV antennas save the previous the navigation positions and guarantee increased signal reception performance even at the edges of the signal coverage area. River 4 "NEO" is managed through the free Glomex SAT TV App available for iOS and Android devices.

By downloading the app, you can manage the "NEO" satellite TV antennas in one click via Bluetooth® with your own smartphone/tablet and:

update the satellites list;

- ▶ update the antenna;
- ▶ select and change satellites;
- ▶ send the operating parameters of the antenna to technical assistance in case of need.

Supplied accessories:

12/24 Vdc control unit.

- ▶ 10m (33') coaxial cable.
- ▶ 1,5m (5') coaxial cable.
- ▶ High thickness synthetic rubber gasket.
- ▶

TECHNOLOGY	DVB-S2 4K FULL HD
DISH DIAMETER	600 mm (24")
RADOME DIMENSIONS	660x660 mm (26x26")
LNB	Universal single
APP	yes
COAX CABLE	4
RECEIVER OUTPUT	1/16
WEIGHT	16 kg (35.3 lb)
TRACKING	AZ 25° sec / EL 25° sec
GAIN	36,5 dB (12 GHz)
SKEW	Manual
DISH TYPE	Prime Focus + HPD
POLARIZATION	Linear (H + V)
LNB FREQUENCY RANGE	10,7 – 12,75 GHz LNB universal
RADOME TYPE	U.V. resistant
POWER REQUIREMENT	12 Vdc
OPERATING TEMPERATURE RANGE	-20° +55°
AZIMUTH	Unlimited
ELEVATION	5° / 90°
TYPE OF STABILIZATION	gyro on 2 axis + 3° axis by interpolation
SATELLITE IDENTIFICATION	NIT (Network Information Table)
MIN EIRP	47 dBW
FUTURE UPGRADES READY	yes
CONTROL UNIT	unlimited

More info on www.glomex.it

River 4 "NEO" est la nouvelle antenne TV satellite FULL-HD / 4K contrôlée sans fil pour bateaux fluviaux avec un disque de 60 cm pour utiliser jusqu'à 16 téléviseurs simultanément. Comme toutes les antennes de télévision par satellite Glomex "NEO", River 4 est équipé d'un système de verrouillage par satellite ultra-rapide même dans des conditions de mer extrêmement agitée grâce à une électronique et une mécanique totalement renouvelées: processeur plus puissant, pilote plus rapide et plus robuste. En outre, la nouvelle électronique a été conçue pour avoir des antennes de télévision par satellite extrêmement silencieuses, à la fois dans la phase de recherche satellite et dans la phase de poursuite. Grâce à l'introduction d'un tout nouveau système GPS, les nouvelles antennes de télévision par satellite "NEO" mémorisent les positions de navigation précédemment parcourues et garantissent des performances accrues de réception du signal, même en bordure de la zone de couverture du signal. River 4 "NEO" est géré via l'application gratuite Glomex SAT TV disponible pour les appareils iOS et Android.

En téléchargeant l'application, vous pouvez vous connecter à l'antenne TV satellite via Bluetooth® en un seul clic:

- ▶ mettre à jour l'antenne.
- ▶ mettre à jour la liste des satellites d'antenne.
- ▶ sélectionner et modifier les satellites.
- ▶ envoyer les paramètres de fonctionnement de l'antenne à l'assistance technique en cas de besoin.

Accessoires inclus:

- ▶ control unit 12/24 Vdc.
- ▶ Câble coaxial 10m.
- ▶ Câble coaxial 1,5m.
- ▶ Joint en gomme synthétique

River 4 "NEO" è la nuova antenna TV satellitare FULL-HD/4K per barche da fiume a controllo wireless con disco da 60cm per utilizzare massimo 16 TV contemporaneamente. Come tutte le antenne TV satellitari Glomex "NEO", River 4 è dotata di un sistema super veloce di aggancio del satellite anche in condizioni estreme di mare mosso grazie ad una elettronica e meccanica totalmente rinnovate: processore più potente, driver più veloce e struttura più robusta. Inoltre, la nuova elettronica è stata progettata per avere delle antenne TV satellitari estremamente silenziose, sia in fase di ricerca del satellite sia in fase di tracking. Grazie all'introduzione di un nuovissimo sistema GPS, le nuove antenne TV satellitari "NEO" memorizzano le posizioni di navigazione precedentemente percorse e garantiscono prestazioni di ricezione del segnale incrementate anche ai margini dell'area di copertura del segnale. River 4 "NEO" è gestita tramite l'App gratuita Glomex SAT TV disponibile per i dispositivi iOS e Android.

Scaricando l'App è possibile collegarsi all'antenna TV satellitare tramite Bluetooth® e con un solo clic:

- ▶ aggiornare l'antenna.
- ▶ aggiornare l'elenco dei satelliti dell'antenna.
- ▶ selezionare e cambiare i satelliti.
- ▶ inviare i parametri operativi dell'antenna all'assistenza tecnica in caso di necessità.

Prodotti inclusi con l'antenna:

- ▶ unità di controllo 12/24 Vdc.
- ▶ Cavo coassiale da 10m.
- ▶ Cavo coassiale da 1,5m.
- ▶ Guarnizione in gomma.

SUPPLIED ACCESSORIES



▲ 12/24Vdc control unit



▲ 10m (33') coax cables (4 pcs)



▲ 1,5m (5') coaxial cable



▲ High thickness synthetic rubber gasket

OPTIONAL ACCESSORIES



▲ V9500 mount



▲ R9804NTWIN twin radome



Rhine 4 dCSS "Neo"

60cm (24") dish diameter, wireless controlled, only 1 cable for 1/16 outputs, for river boats

Category: SAT TV

Subcategories: dCSS River Antennas

Code: R9804N/DCSS



River 4 "NEO" DCSS is the new FULL-HD / 4K wirelessly controlled satellite TV antenna for river boats with 60cm disc to use up to 16 TVs simultaneously. Developed with the dCSS / SCR technology, River 4 "NEO" DCSS has been specially manufactured to be used with the dCSS decoders, for example the Sky Q decoders, and to exploit all their features (such as recording a program while watching a other channel). The dCSS technology also has the great advantage of making installation extremely simple and fast thanks to a single cable that comes down from the antenna even for multi-output installations. Like all Glomex "NEO" satellite TV antennas, River 4 is equipped with a super fast satellite locking system even in extreme rough sea conditions thanks to totally renewed electronics and mechanics: more powerful processor, faster driver and more robust. Furthermore, the new electronics have been designed to have extremely quiet satellite TV antennas, both in the satellite search phase and in the tracking phase. Thanks to the introduction of a brand new GPS system, the new "NEO" satellite TV antennas save the previous the navigation positions and guarantee increased signal reception performance even at the edges of the signal coverage area. River 4 "NEO" is managed through the free Glomex SAT TV App available for iOS and Android devices.

By downloading the app, you can manage the "NEO" satellite TV antennas in one click via Bluetooth® with your own smartphone/tablet and:

- ▶ update the satellites list
- ▶ update the antenna
- ▶ select and change satellites
- ▶ send the operating parameters of the antenna to technical assistance in case of need.

TECHNOLOGY	DVB-S2 4K FULL HD
DISH DIAMETER	600 mm (24")
RADOME DIMENSIONS	660x660 mm (26x26")
LNB	Universal single
APP	yes
COAX CABLE	1
RECEIVER OUTPUT	1/16
WEIGHT	16 kg (35.3 lb)
TRACKING	AZ 25° sec / EL 25° sec
GAIN	36,5 dB (12 GHz)
SKEW	Manual
DISH TYPE	Prime Focus + HPD
POLARIZATION	Linear (H + V)
LNB FREQUENCY RANGE	10,7 – 12,75 GHz LNB universal
RADOME TYPE	U.V. resistant
POWER REQUIREMENT	12 Vdc
OPERATING TEMPERATURE RANGE	-20° +55°
AZIMUTH	Unlimited
ELEVATION	5° / 90°
TYPE OF STABILIZATION	gyro on 2 axis + 3° axis by interpolation
SATELLITE IDENTIFICATION	NIT (Network Information Table)
MIN EIRP	47 dBW
FUTURE UPGRADES READY	yes
CONTROL UNIT	unlimited

More info on www.glomex.it

Supplied accessories:

- ▶ 12/24 Vdc control unit.
- ▶ 10m (33') coaxial cable.
- ▶ 1,5m (5') coaxial cable.
- ▶ High thickness synthetic rubber gasket.

River 4 "NEO" DCSS est la nouvelle antenne TV satellite FULL-HD / 4K contrôlée sans fil pour bateaux fluviaux avec un disque de 60 cm pour utiliser jusqu'à 16 téléviseurs simultanément. Avec la technologie dCSS / SCR, River 4 "NEO" DCSS est été spécialement développée pour être utilisée avec les nouveaux décodeurs dCSS, par exemple les décodeurs Sky Q, et pour exploiter toutes leurs fonctionnalités (comme l'enregistrement d'un programme tout en regardant un autre canal). La technologie dCSS présente également le grand avantage de rendre l'installation extrêmement simple et rapide grâce à un seul câble qui descend de l'antenne même pour les installations multi-sorties. Comme toutes les antennes de télévision par satellite Glomex "NEO", River 4 est équipé d'un système de verrouillage par satellite ultra-rapide même dans des conditions de mer extrêmement agitée grâce à une électronique et une mécanique totalement renouvelées: processeur plus puissant, pilote plus rapide et plus robuste. En outre, la nouvelle électronique a été conçue pour avoir des antennes de télévision par satellite extrêmement silencieuses, à la fois dans la phase de recherche satellite et dans la phase de poursuite. Grâce à l'introduction d'un tout nouveau système GPS, les nouvelles antennes de télévision par satellite "NEO" mémorisent les positions de navigation précédemment parcourues et garantissent des performances accrues de réception du signal, même en bordure de la zone de couverture du signal. Les modèles d'antenne dotés de la nouvelle River 4 "NEO" est géré via l'application gratuite Glomex SAT TV disponible pour les appareils iOS et Android.

En téléchargeant l'application, vous pouvez vous connecter à l'antenne TV satellite via Bluetooth® en un seul clic:

- ▶ mettre à jour l'antenne.
- ▶ mettre à jour la liste des satellites d'antenne.
- ▶ sélectionner et modifier les satellites.
- ▶ envoyer les paramètres de fonctionnement de l'antenne à l'assistance technique en cas de besoin.

Accessoires inclus:

- ▶ control unit 12/24 Vdc.
- ▶ Câble coaxial 10m.
- ▶ Câble coaxial 1,5m.
- ▶ Joint en gomme synthétique.

River 4 "NEO" DCSS è la nuova antenna TV satellitare FULL-HD/4K a controllo wireless per barche da fiume con disco da 60cm per utilizzare massimo 16 TV contemporaneamente. Questa versione è stata sviluppata per i decoder dCSS, ad esempio i decoder Sky Q, e per sfruttarne tutte le loro funzionalità (come la registrazione di un programma in contemporanea alla visione di un altro canale). La tecnologia dCSS inoltre ha il grande vantaggio di rendere l'installazione estremamente semplice e veloce grazie ad un unico cavo che scende dall'antenna anche per le installazioni a multi-uscita. Come tutte le antenne TV satellitari Glomex "NEO", River 4 è dotata di un sistema super veloce di aggancio del satellite anche in condizioni estreme di mare mosso grazie ad una elettronica e meccanica totalmente rinnovate: processore più potente, driver più veloce e struttura più robusta. Inoltre, la nuova elettronica è stata progettata per avere delle antenne TV satellitari estremamente silenziose, sia in fase di ricerca del satellite sia in fase di tracking. Grazie all'introduzione di un nuovissimo sistema GPS, le nuove antenne TV satellitari "NEO" memorizzano le posizioni di navigazione precedentemente percorse e garantiscono prestazioni di ricezione del segnale incrementate anche ai margini dell'area di copertura del segnale. River 4 "NEO" è gestita tramite l'App gratuita Glomex SAT TV disponibile per i dispositivi iOS e Android.

Scaricando l'App è possibile collegarsi all'antenna TV satellitare tramite Bluetooth® e con un solo clic:

- ▶ aggiornare l'antenna.
- ▶ aggiornare l'elenco dei satelliti dell'antenna.
- ▶ selezionare e cambiare i satelliti.
- ▶ inviare i parametri operativi dell'antenna all'assistenza tecnica in caso di necessità.

Prodotti inclusi con l'antenna:

- ▶ unita' di controllo 12/24 Vdc.
- ▶ Cavo coassiale da 10m.
- ▶ Cavo coassiale da 1,5m.
- ▶ Guarnizione in gomma.

SUPPLIED ACCESSORIES



▲ 12/24Vdc control unit



▲ 10m (33') coax cable



▲ 1,5m (5') coaxial cable



▲ High thickness synthetic rubber gasket

OPTIONAL ACCESSORIES



▲ V9500 mount



▲ R9804NTWIN twin radome



V9500

stainless steel adjustable mount for satellite and directional TV antennas

Category: SAT TV

Subcategories: Accessories

Code: V9500

🇬🇧 0-5° stainless steel adjustable mount for satellite and directional TV antennas, diameter 240 mm/9" and height 80 mm/3".

🇫🇷 Support réglable 0-5° en acier inoxydable pour antennes TV satellitaires, diamètre 240mm et hauteur 80mm.

🇮🇹 Supporto regolabile in acciaio inox per antenne TV satellitari e direttive con inclinazione 0-5°, diametro 240 mm e altezza 80 mm



V8001NTWIN

Twin radome for Pandora "NEO" antenna

Category: SAT TV

Subcategories: Accessories

Code: V8001NTWIN

🇬🇧 Twin radome for Pandora "NEO" antenna

🇫🇷 Radôme jumeau pour l'antenne Pandora "NEO"

🇮🇹 Radome gemello per antenna Pandora "NEO"

V8100NTWIN

Twin radome for Rhea "NEO" antenna

Category: SAT TV

Subcategories: Accessories

Code: V8100NTWIN



 Twin radome for Rhea "NEO" antenna

 Radôme jumeau pour l'antenne Rhea "NEO"

 Radome gemello per antenna Rhea "NEO"

V9104NTWIN

Twin radome for Saturn 4 "NEO" antenna

Category: SAT TV

Subcategories: Accessories

Code: V9104NTWIN



 Twin radome for Saturn 4 "NEO" antenna

 Radôme jumeau pour l'antenne Saturn 4 "NEO"

 Radome gemello per antenna Saturn 4 "NEO"





V9804NTWIN

Twin radome for Mars "NEO" antenna

Category: SAT TV

Subcategories: Accessories

Code: V9804NTWIN

-  Twin radome for Mars "NEO" antenna
-  Radôme jumeau pour l'antenne Mars "NEO"
-  Radome gemello per antenna Mars "NEO"





R9804NTWIN

Twin radome for Rhine 4 "NEO" antenna

Category: SAT TV

Subcategories: Accessories

Code: R9804NTWIN

-  Twin radome for Rhine "4 NEO" antenna
-  Radôme jumeau pour l'antenne Rhine 4 "NEO"
-  Radome gemello per antenna Rhine 4 "NEO"





Avior

10x21cm (4x8") DVB-T2 TV antenna - inner amplifier - TV and FM signals reception

Category: DVB-T2

Subcategories: Antennas

Code: VT300, VT300/BK



Avior is the TV/RADIO FM Omnidirectional antenna in the Glomex range characterized by very compact dimensions (diameter 100 mm/4" and height 210 mm/8"). It enables the user to watch TV programs broadcasted with analog and digital terrestrial system and to listen the radio. The new amplifier allows Avior to have an increase in the gain and to receive vertically and horizontally polarized TV signals coming from more directions at the same time. The inner amplifier, coupled to the power inserter with 2 independent outputs for TV and radio (V9114PI-FM), allows the reception of VHF and UHF and FM frequencies with a single antenna. Avior can be installed on any kind of boat, whether sailboat or motorboat, and can be matched to the VHF RA121 antenna.

Supplied accessories:

- ▶ 2 way power inserter TV - AM/FM.
- ▶ 10m (33') coaxial cable to connect the antenna with the inserter.
- ▶ 1,5m (5') coaxial cable to connect the inserter to the TV / decoder.
- ▶ Nylon mount

ANTENNA DIAMETER	100 mm (4")
ANTENNA HEIGHT	210 mm (8")
BASE DIAMETER	25 mm (1")
ANTENNA WEIGHT	250 g (8,81 oz)
RADOME MATERIAL	U.V. resistant ASA
ANGLE OF RECEPTION	360°
POLARIZATION	Horizontal/Vertical
IMPEDANCE	75 ohms
FREQUENCY RANGE	40/890 MHz
GAIN AVERAGE	24,5 dB
NOISE FACTOR	1,7 dB
POWER CONSUMPTION	20 mA
POWER SUPPLY	12 Vdc
TV SET MAX	1
TERMINATION	F female
CONNECTOR SUPPLIED	F male gold plated connector (V9144)
<i>More info on www.glomex.it</i>	

Avior est l'antenne omnidirectionnelle TV/RADIO FM de la gamme Glomex caractérisée par dimensions vraiment compactes (diamètre 100 mm et hauteur 210 mm), pour regarder les programmes TV analogique et numérique terrestre et pour écouter la radio. Avec le nouvel amplificateur Avior peut recevoir des signaux TV polarisés aussi bien verticalement qu'horizontalement, provenant de plusieurs directions en même temps. L'amplificateur interne, couplé au bloc d'alimentation de tension avec 2 sorties indépendantes pour TV et radio (V9114PI-FM), permet de recevoir aussi bien les fréquences VHF et UHF que les fréquences FM avec une seule antenne. Avior peut être installée sur tout type de bateau, aussi bien à voile qu'à moteur, et peut être assemblée à l'antenne VHF RA121.

Accessoires inclus:

- ▶ inserteur avec 2 sorties pour TV et radio AM/FM.
- ▶ Câble coaxial 10m pour connecter l'antenne à l'inserteur.
- ▶ Câble coaxial 1,5m pour connecter l'inserteur au téléviseur / décodeur.
- ▶ Base en nylon

Avior è l'antenna TV omnidirezionale più compatta della gamma Glomex; estremamente ridotta nelle dimensioni con un diametro di appena 100 mm e un'altezza di 210 mm, per ricevere i segnali televisivi analogico-digitali sia in polarizzazione orizzontale che verticale. Grazie al nuovo amplificatore ad alte performance e a bassa figura di rumore, Avior è in grado di ricevere in maniera molto efficace il segnale da più direzioni contemporaneamente. Inoltre, l'amplificatore interno, accoppiato all'insertore di tensione con 2 uscite indipendenti per TV e radio (V9114PI-FM), permette di ricevere con un'unica antenna le frequenze VHF e UHF. Avior può essere facilmente installata su ogni tipo di imbarcazione, a vela o a motore, e può essere abbinata all'antenna VHF RA121, identica nelle dimensioni.

Prodotti inclusi con l'antenna:

- ▶ insertore a doppia uscita (TV/FM).
- ▶ Cavo coassiale da 10 metri per collegare l'antenna all'insertore di tensione.
- ▶ Cavo coassiale da 1,5 metri per collegare l'insertore alla TV / decoder.
- ▶ Base in nylon per installazione su ponte.

SUPPLIED ACCESSORIES



▲ 2 way power inserter TV/FM



▲ 10m (33') coax cable



▲ 1,5m (5') coax cable



▲ nylon mount



OPTIONAL ACCESSORIES

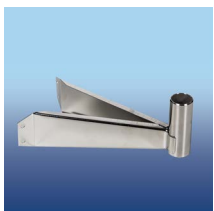

▲ V9123 stainless steel masthead mount



▲ V9124 stainless steel deck mount



▲ V9148 3,6m (12') AM/FM radio cable



Alya

25cm (10") DVB-T2 TV antenna - inner amplifier - TV, DAB and FM signals reception

Category: DVB-T2

Subcategories: Antennas

Code: RA304TV, RA304TV/BK



Alya is an extremely compact (only 25cm high) whip terrestrial TV antenna with internal amplifier. Through the supplied power inserter, it is possible to connect the antenna to a TV and to the DAB or FM radio. Alya is supplied with the new F / F fast fitting connector to prevent the cable from twisting, for a super fast and extremely easy installation. Alya can be installed on any kind of boat, whether sailboat or motorboat, and can be matched to the VHF RA304, AIS RA304AIS, and cellular/internet RA304W antennas.

Supplied accessories:

- ▶ 2 Way power inserter TV - AM/FM.
- ▶ 5m (16') coaxial cable to connect the antenna with the inserter.
- ▶ 1,5m (5') coaxial cable to connect the inserter to the TV / decoder.
- ▶ F/f fast fitting connector.

ANTENNA DIAMETER	20 mm (0.8")
ANTENNA HEIGHT	250 mm (10")
BASE DIAMETER	5/8"X14 mm
ANTENNA WEIGHT	150 g (5 oz)
RADOME MATERIAL	U.V. resistant ASA
ANGLE OF RECEPTION	360°
POLARIZATION	Horizontal/Vertical
IMPEDANCE	75 ohms
FREQUENCY RANGE	175/240 MHz 470/860 MHz
GAIN AVERAGE	24,5 dB
NOISE FACTOR	1,7 dB
POWER CONSUMPTION	20 mA
POWER SUPPLY	12 Vdc
TV SET MAX	1
TERMINATION	F female
CONNECTOR SUPPLIED	F male gold plated connector (V9144)
<i>More info on www.glomex.it</i>	

Alya est une antenne TV TNT extrêmement compacte (seulement 25 cm de haut) avec amplificateur interne. Grâce à l'inserteur d'alimentation fourni, il est possible de connecter l'antenne à un téléviseur et à la radio DAB ou FM. Alya est fourni avec le nouveau connecteur à montage rapide F/F pour empêcher le câble de se tordre, pour une installation ultra rapide et extrêmement facile. Alya peut être installée sur tout type de bateau, que ce soit un voilier ou un bateau à moteur, et peut être associée aux antennes VHF RA304, AIS RA304AIS, et cellulaire/internet RA304W.

Accessoires inclus:

- ▶ inserteur avec 2 sorties pour TV et radio AM/FM.
- ▶ Câble coaxial 5m pour connecter l'antenne à l'inserteur.
- ▶ Câble coaxial 1,5m pour connecter l'inserteur au téléviseur / décodeur.
- ▶ Connecteur f/f fast fitting

Alya è un'antenna TV terrestre a canna estremamente compatta (alta solo 25 cm) con amplificatore interno. Tramite l'alimentatore in dotazione è possibile collegare l'antenna ad una TV e alla radio DAB o FM. Alya viene fornita con il nuovo connettore F/F ad innesto rapido per evitare la torsione del cavo, per un'installazione super veloce ed estremamente facile. Alya può essere installata su qualsiasi tipo di imbarcazione, sia a vela sia a motore, e può essere abbinata alle antenne VHF RA304, AIS RA304AIS e cellulare/internet RA304W.

Prodotti inclusi con l'antenna:

- ▶ inseritore a doppia uscita (TV/FM/DAB).
- ▶ Cavo coassiale da 5 metri per collegare l'antenna all'inseritore di tensione.
- ▶ Cavo coassiale da 1,5 metri per collegare l'inseritore alla TV / decoder.
- ▶ Connettore fast fitting f-f.

SUPPLIED ACCESSORIES



▲ 2 way power inserter TV/FM



▲ 5m (16') coax cable



▲ 1,5m (5') coax cable

OPTIONAL ACCESSORIES



▲ RA135FME nylon 4 way ratchet mount. Thread 5/8"x14



▲ RA135FME-BK black nylon 4 way ratchet mount. Thread 5/8"x14

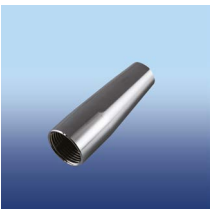

▲ RA358 5/8"x24 / 1"x14 stainless steel adaptor ferrule



▲ RA369 chromed plated deck flange with nut and washer



▲ RA106BRACKINOX stainless steel masthead bracketed



▲ RA106BRACKINOX-L stainless steel L masthead bracketed



▲ V9148 3,6m (12') AM/FM radio cable



Mizar AGC

14x20cm (5.5x8") DVB-T2 TV antenna - automatic gain amplifier - TV, DAB and FM signals reception

Category: DVB-T2

Subcategories: Antennas

Code: V9128AGC



MIZAR AGC is a compact omnidirectional DVB-T2 TV and DAB antenna that makes your life easier and more comfortable with the innovative automatic gain control amplifier. Moreover, in order to keep a balanced look of your boat, Mizar AGC can be matched to weBBoat 4G Lite, the integrated internet antenna system, as they are identical in shape and size. Thanks to the amplifier you have only to turn on the TV, stay comfortably seated and enjoy your favourite programs; Mizar AGC will adjust by itself the gain of the TV signal to ensure the best possible reception of television broadcasts. Mizar AGC is a very compact (diam.: 14 cm/5.5" diam, height: 20 cm/8, weight: 500 gr/1.1lb) Omni-directional TV antenna ensuring high performance in signal reception with both polarizations: horizontal and vertical.

ANTENNA DIAMETER	140 mm (5.5")
ANTENNA HEIGHT	200 mm (8")
BASE DIAMETER	1"x14
ANTENNA WEIGHT	500 g (1.1lb)
RADOME MATERIAL	U.V. resistant ASA
ANGLE OF RECEPTION	360°
POLARIZATION	Horizontal/Vertical
IMPEDANCE	75 ohms
FREQUENCY RANGE	87,5/774 MHz
GAIN AVERAGE	20 dB
NOISE FACTOR	2,2 dB
POWER CONSUMPTION	60 mA
POWER SUPPLY	12/24 Vdc
ADJUSTABLE GAIN	AUTOMATIC
TV SET MAX	2
TERMINATION	F female
CONNECTOR SUPPLIED	F male gold plated connector (V9144)
<i>More info on www.glomex.it</i>	

Supplied accessories:

- ▶ 50023/14 automatic gain control amplifier.
- ▶ 20m (66') coaxial cable to connect the antenna with the amplifier.
- ▶ 1,5m (5') set cord to connect the amplifier to the TV / decoder.
- ▶ V9144 f-male gold plated connector.
- ▶ Flush mounter for installation on roll-bar.
- ▶ Threaded termination for 1 "x14 mount.

MIZAR AGC est l'antenne TV DVB-T2 et DAB noir compacted qui vous rend la vie plus facile et plus confortable avec l'innovant amplificateur de contrôle de gain automatique. De plus, afin de garder un aspect équilibré de votre bateau, Mizar AGC peut être adapté au weBBoat 4G Lite, le système intégré pour surfer sur internet dans la côte, car ils sont identiques en forme et en taille. Grâce à l'amplificateur, vous n'avez qu'à allumer le téléviseur, rester confortablement assis et profiter de vos programmes préférés; Mizar AGC ajustera de lui-même le gain du signal TV pour assurer la meilleure réception possible des émissions de télévision. Mizar AGC est une antenne TV omnidirectionnelle très compacte (diamètre: 14 cm, hauteur: 20 cm, poids: 500 g) assurant des performances élevées dans la réception du signal avec les deux polarisations: horizontale et verticale.

Accessoires inclus:

- ▶ Amplificateur automatique du gain 50023/14.
- ▶ Câble coaxial 20m pour connecter l'antenne a l'amplificateur.
- ▶ Câble coaxial 1,5m pour connecter l'amplificateur au téléviseur / décodeur.
- ▶ Connecteur V9144 f-male.
- ▶ Base plate pour l'installation sur roll-bar.
- ▶ Terminaison filetee pour base 1 "x14

MIZAR AGC é l'antenna TV omnidirezionale per il digitale terrestre e per ricevere la radio DAB compatta che ti semplifica la vita con l'innovativo amplificatore a controllo automatico del guadagno. Inoltre, al fine di mantenere un aspetto equilibrato della tua barca, Mizar AGC può essere abbinato a weBBoat 4G Lite, il sistema integrato per avere internet lungo la costa, poiché sono identici per forma e dimensioni. Grazie all'amplificatore devi solo accendere la TV, stare comodamente seduto e goderti i tuoi programmi preferiti; Mizar AGC regolerà da sola il guadagno del segnale TV per garantire la migliore ricezione possibile delle trasmissioni televisive digitali. Mizar AGC è un'antenna TV omnidirezionale molto compatta (diametro: 14 cm, altezza: 20 cm, peso: 500 g) che garantisce alte prestazioni nella ricezione del segnale con entrambe le polarizzazioni: orizzontale e verticale.

Prodotti inclusi con l'antenna:

- ▶ Amplificatore automatico del guadagno 50023/14.
- ▶ Cavo coassiale da 20m per collegare l'antenna all'amplificatore.
- ▶ Cavo coassiale da 1,5m per collegare l'amplificatore alla tv / decoder.
- ▶ Connettore V9144 f-maschio.
- ▶ Base piatta per installazione su roll-bar.
- ▶ Terminazione filettata per basi 1"x14

SUPPLIED ACCESSORIES



▲ 50023/14 automatic gain control amplifier



▲ 20m (66') coaxial cable



▲ 1,5m (5') set cord



▲ V9144 F-male gold plated connector

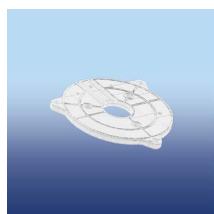

▲ Flush mount
Threaded termination for 1"x14 mounts

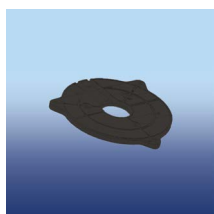

▲ Threaded termination for 1"x14 mounts



OPTIONAL ACCESSORIES



▲ V9175OT nylon mount



▲ V9177 stainless steel mount



▲ ITM002 nylon mount for cross tree



▲ V9148 3,6m (12') AM/FM radio cable



▲ V9147 2 way splitter (TV/TV - TV/RADIO)



Altair AGC

25x30cm (10x12") DVB-T2 TV antenna - automatic gain amplifier - TV, DAB and FM signals reception

Category: DVB-T2

Subcategories: Antennas

Code: V9126AGC, V9126AGC/BK



Altair evolves in Altair AGC to make your life easier and more comfortable with the new and innovative automatic gain control amplifier. Thanks to the new amplifier you have only to turn on the TV, stay comfortably seated on the sofa and enjoy your favourite programs; Altair AGC (diameter: 25 cm / 10") will adjust by itself the gain of the TV signal to ensure the best possible reception of television broadcasts. With conventional amplifiers, in fact, you have to manually adjust the TV signal gain by lowering the amplification when the signal is high and by increasing the amplification when the boat is at sea and far from the TV transmitter. With the new Altair AGC, everything will happen automatically and the innovative amplifier can be placed in a hidden location inside the boat.

Altair is the ideal solution for any type of boats: sailboat and motorboats.

Supplied accessories:

- ▶ 50023/14 automatic gain control amplifier.
- ▶ 20m (66') coaxial cable to connect the antenna with the amplifier.
- ▶ 1,5m (5') set cord to connect the amplifier to the TV / decoder.
- ▶ V9144 f-male gold plated connector.

ANTENNA DIAMETER	250 mm (10")
ANTENNA HEIGHT	300 mm (12")
BASE DIAMETER	25mm (1")
ANTENNA WEIGHT	430 g (15,74 oz)
RADOME MATERIAL	U.V. resistant ASA
ANGLE OF RECEPTION	360°
POLARIZATION	Horizontal/Vertical
IMPEDANCE	75 ohms
FREQUENCY RANGE	40/890 MHz
GAIN AVERAGE	24 dB
NOISE FACTOR	2,1 dB
POWER CONSUMPTION	60 mA
POWER SUPPLY	12/24 Vdc
ADJUSTABLE GAIN	AUTOMATIC
TV SET MAX	2
TERMINATION	F female
CONNECTOR SUPPLIED	F male gold plated connector (V9144)
<i>More info on www.glomex.it</i>	

Altair est une antenne TV omnidirectionnelle garantissant une performance élevée et la réception des signaux dans les deux polarisations: horizontale et verticale. En effet, Altair, comparée aux autres antennes omnidirectionnelles, a un radôme aux dimensions telles (diamètre 250 mm, hauteur 300 mm), qui permet l'installation d'un élément de réception verticale à l'intérieur de celui-ci. Altair est équipée d'un amplificateur avec ajustement automatique du gain (50023/14). Pour maintenir un aspect équilibré à votre bateau, Altair peut être installée avec l'antenne VHF RA124, car de forme et de dimension identiques.

Accessoires inclus:

- ▶ Amplificateur automatique du gain 50023/14.
- ▶ Câble coaxial 20m pour connecter l'antenne a l'amplificateur.
- ▶ Câble coaxial 1,5m pour connecter l'amplificateur au téléviseur / décodeur.
- ▶ Base en nylon

Altair è l'antenna TV omnidirezionale che garantisce elevate performance nella ricezione dei segnali in entrambe le polarizzazioni: orizzontale e verticale. Rispetto alle altre antenne omnidirezionali, infatti, Altair ha un radome di dimensioni tali (diametro 250 mm/10", altezza 300 mm/12") da permettere l'installazione dell'elemento di ricezione verticale al proprio interno. Altair è dotata di un amplificatore con regolazione automatica del guadagno. Per mantenere un look bilanciato sulla propria imbarcazione, Altair può essere abbinata all'antenna VHF RA124, identica per forma e dimensione.

Prodotti inclusi con l'antenna:

- ▶ Amplificatore automatico del guadagno 50023/14.
- ▶ Cavo coassiale da 20m per collegare l'antenna all'amplificatore.
- ▶ Cavo coassiale da 1,5m per collegare l'amplificatore alla tv / decoder.
- ▶ Base in nylon.

SUPPLIED ACCESSORIES



▲ 50023/14 automatic gain control amplifier



▲ 20m (66') coaxial cable



▲ 1,5m (5') set cord



▲ V9144 F-male gold plated connector nylon mount



▲ nylon mount



OPTIONAL ACCESSORIES



▲ V9124 stainless steel mount



▲ V9148 3,6m (12') AM/FM radio cable



▲ V9147 2 way splitter (TV - TV/RADIO)



Talitha AGC DAB 20

25cm (10") DVB-T2 TV antenna - automatic gain amplifier - TV, DAB and FM signals reception

Category: DVB-T2

Subcategories: Antennas

Code: V9125AGCU/DAB20, V9125AGCU/DAB20/BK



Talitha evolves in Talitha AGC to make your life easier and more comfortable with the new and innovative automatic gain control amplifier. Moreover, it also receives the DAB radio signals. Thanks to the new amplifier you have only to turn on the TV, stay comfortably seated on the sofa and enjoy your favourite programs; Talitha AGC (diameter: 25 cm / 10") will adjust by itself the gain of the TV signal to ensure the best possible reception of television broadcasts. With conventional amplifiers, in fact, you have to manually adjust the TV signal gain by lowering the amplification when the signal is high and by increasing the amplification when the boat is at sea and far from the TV transmitter.

With the new Talitha AGC, everything will happen automatically and the innovative amplifier can be placed in a hidden location inside the boat. This innovation increases the Nashira key points that have allowed Talitha to be the best-selling marine DVB-T and DVB-T2 TV antenna in the world for more than 30 years: its always appreciated essential style, aerodynamic lines with the "shark fin" (55mm/2.2" high) for receiving the vertically polarized TV signals, reinforced base to ensure maximum stability of the antenna in any condition of navigation, compact size (370 mm/14" diameter) and high quality construction materials. Talitha is the ideal solution for any type of boats: sailboat and motorboats.

ANTENNA DIAMETER	250 mm (10")
ANTENNA HEIGHT	425 mm (16.8")
BASE DIAMETER	25 mm (1")
ANTENNA WEIGHT	900 g (31,74 oz) [975 g (34,39 oz) with shark fin]
RADOME MATERIAL	U.V. resistant ASA
ANGLE OF RECEPTION	360°
POLARIZATION	Horizontal/Vertical
IMPEDANCE	75 ohms
FREQUENCY RANGE	40/890 MHz
GAIN AVERAGE	20 dB
NOISE FACTOR	2,2 dB
POWER CONSUMPTION	20 mA
POWER SUPPLY	12/24 Vdc
ADJUSTABLE GAIN	AUTOMATIC
TV SET MAX	2
TERMINATION	F female
CONNECTOR SUPPLIED	F male gold plated connector (V9144)
<i>More info on www.glomex.it</i>	

Supplied accessories:

- ▶ 50023/14 automatic gain control amplifier.
- ▶ 20m (66') coaxial cable to connect the antenna with the amplifier.
- ▶ 1,5m (5') set cord to connect the amplifier to the TV / decoder.
- ▶ V9144 f-male gold plated connector. Dab whip.

Talitha évolue en Talitha AGC pour vous rendre la vie plus facile et plus à l'aise avec ce nouveau et innovant amplificateur avec son contrôle automatique du gain. De plus, il reçoit les chaînes de radio diffusées en DAB. Grâce à ce nouveau amplificateur il suffit d'allumer le téléviseur et de rester confortablement assis et profitez de vos programmes favoris, ce sera Talitha AGC qui réglera le gain du signal TV pour assurer à tout moment la meilleure réception possible des émissions de télévision. Avec un amplificateur classique, il était nécessaire d'intervenir manuellement sur l'amplificateur en réduisant l'amplification lorsque le bateau était en mer et loin du répéteur de la télévision. Avec la nouvelle Talitha AGC, tout se fera automatiquement et l'amplificateur innovant pourra être placé dans une position cachée du bateau. Cette innovation s'ajoute aux points de force de Nashira qui l'a rendue l'antenne TV TNT maritime la plus vendue dans le monde depuis 30 ans, avec son style essentiel toujours apprécié pour sa capacité à s'intégrer à merveille sur tous les types de bateau, sa ligne aérodynamique spécialement conçue avec l'"aileron de requin" (haut 55 mm) pour la réception des signaux TV en polarisation verticale, sa taille compacte (diamètre de 250 mm) et matériaux de haut qualité. Si apparée avec un séparateur à 2 sorties (code: V9147, en option) installé entre l'antenne et l'amplificateur, en plus, on pourra recevoir des fréquences radio AM-FM.

Accessoires inclus:

- ▶ Amplificateur automatique du gain 50023/14.
- ▶ Câble coaxial 20m pour connecter l'antenne à l'amplificateur.
- ▶ Câble coaxial 1,5m pour connecter l'amplificateur au téléviseur / décodeur.
- ▶ Connecteur V9144 f-male.
- ▶ Stilo DAB

Talitha si evolve in Talitha AGC per rendervi la vita più facile e comoda grazie al nuovo ed innovativo amplificatore con regolazione. Inoltre, riceve i canali radio trasmessi in DAB. automatica del guadagno. Grazie al nuovo amplificatore non dovrete fare altro che accendere la TV e restare comodamente seduti a godervi i vostri programmi preferiti, sarà Talitha AGC a regolare il guadagno del segnale televisivo per garantirvi sempre e ovunque la migliore ricezione possibile delle trasmissioni televisive. Con i normali amplificatori, infatti, occorre intervenire manualmente nell'amplificatore abbassando l'amplificazione quando la barca è ancorata in marina e aumentando l'amplificazione quando la barca è in navigazione e lontana dai ripetitori TV. Con la nuova Talitha AGC, tutto ciò avverrà in automatico e l'innovativo amplificatore potrà essere collocato in una posizione nascosta della barca. Questa innovazione si aggiunge ai punti di forza di Nashira che l'hanno resa l'antenna TV marina terrestre più venduta al mondo da 30 anni, con il suo stile essenziale apprezzato da sempre per la capacità di integrarsi magnificamente su ogni tipo di imbarcazione, linee aerodinamiche appositamente studiate con la "pinna di squalo" (alta 55 mm/2,2"), per la ricezione dei segnali in polarizzazione verticale, base rinforzata per garantire la massima stabilità dell'antenna in qualsiasi condizione di navigazione, dimensioni compatte (diametro 250 mm) e materiali costruttivi di altissima qualità. Se abbinata ad uno splitter a due uscite (codice: V9147, opzionale) installato tra l'antenna e l'amplificatore, inoltre, può ricevere anche le frequenze radio AM-FM.

Prodotti inclusi con l'antenna:

- ▶ Amplificatore automatico del guadagno 50023/14.
- ▶ Cavo coassiale da 20m per collegare l'antenna all'amplificatore.
- ▶ Cavo coassiale da 1,5m per collegare l'amplificatore alla tv / decoder.
- ▶ Connettore V9144 f-maschio. Stilo DAB

SUPPLIED ACCESSORIES



▲ 50023/14 automatic gain control amplifier



▲ 20m (66') coaxial cable



▲ 1,5m (5') set cord



▲ V9144 F-male gold plated connector

OPTIONAL ACCESSORIES



▲ V9124 stainless steel mount



▲ V9148 3,6m (12') AM/FM radio cable



▲ V9147 2 way splitter (TV/TV - TV/RADIO)



▲ V9123 stainless steel masthead bracket

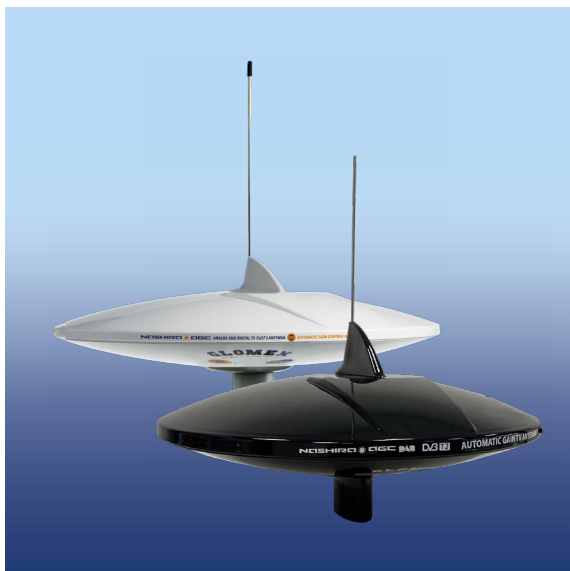

Nashira AGC DAB 20

37cm (14") DVB-T2 TV antenna - automatic gain amplifier - TV, DAB and FM signals reception

Category: DVB-T2

Subcategories: Antennas

Code: V9112AGCU/DAB20, V9112AGCU/DAB20/BK



Nashira evolves in Nashira AGC DAB to make your life easier and more comfortable with the new and innovative automatic gain control amplifier. Moreover, it also receives the DAB radio signals. Thanks to the new amplifier you have only to turn on the TV, stay comfortably seated on the sofa and enjoy your favourite programs; Nashira AGC (diameter: 37 cm / 14") will adjust by itself the gain of the TV signal to ensure the best possible reception of television broadcasts. With conventional amplifiers, in fact, you have to manually adjust the TV signal gain by lowering the amplification when the signal is high and by increasing the amplification when the boat is at sea and far from the TV transmitter.

With the new Nashira AGC, everything will happen automatically and the innovative amplifier can be placed in a hidden location inside the boat. This innovation increases the Nashira key points that have allowed Nashira to be the best-selling marine DVB-T and DVB-T2 TV antenna in the world for more than 30 years: its always appreciated essential style, aerodynamic lines with the "shark fin" (55mm/2.2" high) for receiving the vertically polarized TV signals, reinforced base to ensure maximum stability of the antenna in any condition of navigation, compact size (370 mm/14" diameter) and high quality construction materials.

If matched with a 2-way splitter (code: V9147, optional) installed between the antenna and the amplifier, it can also receive AM-FM radio frequencies. Nashira is the ideal solution for any type of boats: sailboat and motorboats.

ANTENNA DIAMETER	370 mm (14")
ANTENNA HEIGHT	495 mm (19.5")
BASE DIAMETER	25 mm (1")
ANTENNA WEIGHT	900 g (31,74 oz) [975 g (34,39 oz) with shark fin]
RADOME MATERIAL	U.V. resistant ASA
ANGLE OF RECEPTION	360°
POLARIZATION	Horizontal/Vertical
IMPEDANCE	75 ohms
FREQUENCY RANGE	40/890 MHz
GAIN AVERAGE	20 dB
NOISE FACTOR	2,1 dB
POWER CONSUMPTION	20 mA
POWER SUPPLY	12/24 Vdc
ADJUSTABLE GAIN	AUTOMATIC
TV SET MAX	2
TERMINATION	F female
CONNECTOR SUPPLIED	F male gold plated connector (V9144)
<i>More info on www.glomex.it</i>	

Supplied accessories:

- ▶ 50023/14 agc amplifier.
- ▶ 20m (66') coaxial cable to connect the antenna with the amplifier.
- ▶ 1,5m (5') set cord to connect the amplifier to the TV / decoder.
- ▶ V9144 f-male gold plated connector.
- ▶ Dab whip

Nashira AGC vous rendre la vie plus facile et plus à l'aise avec ce nouveau et innovant amplificateur avec son contrôle automatique du gain. De plus, il reçoit les chaînes de radio diffusées en DAB. Grâce à ce nouveau amplificateur il suffit d'allumer le téléviseur et de rester confortablement assis et profitez de vos programmes favoris, ce sera Nashira AGC qui réglera le gain du signal TV pour assurer à tout moment la meilleure réception possible des émissions de télévision. Avec un amplificateur classique, il était nécessaire d'intervenir manuellement sur l'amplificateur en réduisant l'amplification lorsque le bateau est en mer et loin du répéteur de la télévision. Avec la nouvelle Nashira AGC, tout se fera automatiquement et l'amplificateur innovant pourra être placé dans une position cachée du bateau. Cette innovation s'ajoute aux points de force de Nashira qui l'a rendue l'antenne TV TNT maritime la plus vendue dans le monde depuis 30 ans, avec son style essentiel toujours apprécié pour sa capacité à s'intégrer à merveille sur tous les types de bateau, sa ligne aérodynamique spécialement conçue avec l'"aileron de requin" (haut 55 mm) pour la réception des signaux TV en polarisation verticale, sa base renforcée pour assurer une stabilité maximale de l'antenne dans toutes les conditions de navigation, sa taille compacte (diamètre de 370 mm) et matériaux de haute qualité. Si appariée avec un séparateur à 2 sorties (code: V9147, en option) installé entre l'antenne et l'amplificateur, en plus, on pourra recevoir des fréquences radio AM-FM.

Accessoires inclus:

- ▶ Amplificateur avec control automatique du signal 50023/14.
- ▶ Câble coaxial 20m pour connecter l'antenne a l'amplificateur.
- ▶ Câble coaxial 1,5m pour connecter l'amplificateur au téléviseur / décodeur.
- ▶ Connecteur V9144 f-male.
- ▶ Stilo dab

Nashira si evolve in Nashira AGC per rendervi la vita più facile e comoda grazie al nuovo ed innovativo amplificatore con regolazione. Inoltre, riceve i canali radio trasmessi in DAB. automatica del guadagno. Grazie al nuovo amplificatore non dovrete fare altro che accendere la TV e restare comodamente seduti a godervi i vostri programmi preferiti, sarà Nashira AGC a regolare il guadagno del segnale televisivo per garantirvi sempre e ovunque la migliore ricezione possibile delle trasmissioni televisive. Con i normali amplificatori, infatti, occorre intervenire manualmente nell'amplificatore abbassando l'amplificazione quando la barca è ancorata in marina e aumentando l'amplificazione quando la barca è in navigazione e lontana dai ripetitori TV. Con la nuova Nashira AGC, tutto ciò avverrà in automatico e l'innovativo amplificatore potrà essere collocato in una posizione nascosta della barca. Questa innovazione si aggiunge ai punti di forza di Nashira che l'hanno resa l'antenna TV marina terrestre più venduta al mondo da 30 anni, con il suo stile essenziale apprezzato da sempre per la capacità di integrarsi magnificamente su ogni tipo di imbarcazione, linee aerodinamiche appositamente studiate con la "pinna di squalo" (alta 55 mm/2,2"), per la ricezione dei segnali in polarizzazione verticale, base rinforzata per garantire la massima stabilità dell'antenna in qualsiasi condizione di navigazione, dimensioni compatte (diametro 370 mm/14") e materiali costruttivi di altissima qualità. Se abbinata ad uno splitter a due uscite (codice: V9147, opzionale) installato tra l'antenna e l'amplificatore, inoltre, può ricevere anche le frequenze radio AM-FM.

Prodotti inclusi con l'antenna:

- ▶ amplificatore a regolazione automatica del guadagno 50023/14.
- ▶ Cavo coassiale da 20m per collegare l'antenna all'amplificatore.
- ▶ Cavo coassiale da 1,5m per collegare l'amplificatore alla TV / decoder.
- ▶ Connettore V9144 f-maschio.
- ▶ Stilo dab

SUPPLIED ACCESSORIES



▲ 50023/14 automatic gain control amplifier



▲ 20m (66') coaxial



▲ 1,5m (5') set cord



▲ V9144 F-male gold plated connector

OPTIONAL ACCESSORIES



▲ V9172 stainless steel mount



▲ V9148 3,6m (12') AM/FM radio cable



▲ V9147 2 way splitter (TV/TV - TV/RADIO)

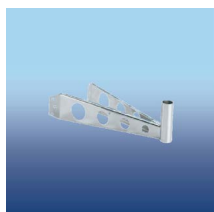

▲ V9173TV stainless steel masthead bracket

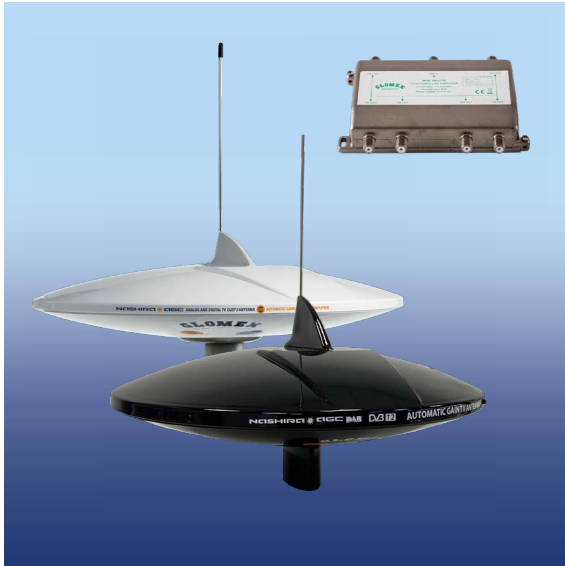

Adhara AGC DAB 20

37cm (14") DVB-T2 TV antenna - for 6 tvs automatic gain amplifier - TV, DAB and FM signals reception

Category: DVB-T2

Subcategories: Antennas

Code: V9150AGC/DAB20, V9150AGC/DAB20/BK



Adhara evolves in Adhara AGC to make your life easier and more comfortable with the new and innovative automatic gain control amplifier. Moreover, it also receives the DAB radio signals. Thanks to the new amplifier you have only to turn on the TV (up to 6 TVs), stay comfortably seated on the sofa and enjoy your favourite programs; Adhara AGC (diameter: 37 cm / 14") will adjust by itself the gain of the TV signal to ensure the best possible reception of television broadcasts. With conventional amplifiers, in fact, you have to manually adjust the TV signal gain by lowering the amplification when the signal is high and by increasing the amplification when the boat is at sea and far from the TV transmitter.

With the new Adhara AGC, everything will happen automatically and the innovative amplifier can be placed in a hidden location inside the boat. This innovation increases the Nashira key points that have allowed Adhara to be the best-selling marine DVB-T and DVB-T2 TV antenna in the world for more than 30 years: its always appreciated essential style, aerodynamic lines with the "shark fin" (55mm/2.2" high) for receiving the vertically polarized TV signals, reinforced base to ensure maximum stability of the antenna in any condition of navigation, compact size (370 mm/14" diameter) and high quality construction materials.

Adhara is the ideal solution for any type of boats: sailboat and motorboats.

ANTENNA DIAMETER	370 mm (14")
ANTENNA HEIGHT	495 mm (19.5")
BASE DIAMETER	25 mm (1")
ANTENNA WEIGHT	975 g (34,4 oz)
RADOME MATERIAL	U.V. resistant ASA
ANGLE OF RECEPTION	360°
POLARIZATION	Horizontal/Vertical
IMPEDANCE	75 ohms
FREQUENCY RANGE	40/890 MHz
GAIN AVERAGE	36 dB
NOISE FACTOR	2,2 dB
POWER CONSUMPTION	20 mA
POWER SUPPLY	12/24 Vdc
ADJUSTABLE GAIN	AUTOMATIC
TV SET MAX	6
TERMINATION	F female
CONNECTOR SUPPLIED	F male gold plated connector (V9144)
<i>More info on www.glomex.it</i>	

Supplied accessories:

- ▶ 50023/14 automatic gain control amplifier
- ▶ 50022/10 6 way line amplifier
- ▶ 20m (66') coaxial cable.
- ▶ 25m (82') coaxial cable - 2 pcs.
- ▶ V9144 f-male gold plated connectors (11 pcs)
- ▶ DAB whip.

ADHARA AGC est une antenne TV omnidirectionnelle renouvelée dans le design et la prestation, en maintenant le style essentiel, dimensions compactes (diamètre 370 mm / 14") et matériaux de haute qualité, développée pour satisfaire les exigences de grands yachts et des bateaux de commerce. Adhara se caractérise pour le design innovant avec le nouveau pinacle en forme d'ailerons de requin (haute 55 mm/2,2"), pour la réception des signaux TV polarisés verticalement, qui s'adapte parfaitement sur le nouveau radome avec des lignes aérodynamiques. Avec le pinacle vertical comme l'«ailerons du requin», Adhara peut recevoir les signaux TV analogiques et numériques terrestres polarisés aussi bien verticalement qu'horizontalement. Adhara est équipée de 2 amplificateurs: l'amplificateur 50023/14 avec le control automatique du gain et 50022/10 qui est à la fois un amplificateur et un répartiteur de signaux vers plusieurs téléviseurs sans perte de qualité.

Accessoires inclus:

- ▶ Amplificateur automatique du gain 50023/14.
- ▶ Amplificateur 50020/10 à 6 sorties.
- ▶ Câble coaxial 20m.
- ▶ Câble coaxial 25m - 2pcs.
- ▶ Connecteurs V9144 F-male (11 pcs).
- ▶ Stilo dab.

La nuova V9150AGC si rinnova in design e prestazioni, nel segno della continuità con lo stile essenziale, le dimensioni compatte (diametro 370 mm/14") e materiali costruttivi di altissima qualità che la rendono ideale per soddisfare le esigenze dei grandi yacht e delle navi commerciali. Adhara si caratterizza per un design innovativo grazie alla nuova appendice a "pinna di squalo" (alta 55 mm/2,2"), per la ricezione dei segnali in polarizzazione verticale, che si integra perfettamente sul radome superiore grazie alle nuove linee aerodinamiche appositamente studiate. Grazie allo stilo verticale inserito all'interno della "pinna di squalo", Adhara è l'antenna TV omnidirezionale che permette la ricezione dei segnali televisivi analogico-digitali in entrambe le polarizzazioni, orizzontale e verticale. Adhara è dotata di 2 amplificatori: il 50023/14 con regolazione automatica del segnale, e il 50022/10, che è sia un amplificatore sia ripartitore del segnale tra più televisori senza perdita di qualità.

Prodotti inclusi con l'antenna:

- ▶ Amplificatore automatico del guadagno 50023/14.
- ▶ Amplificatore switch a 6 uscite 50022/10.
- ▶ Cavo coassiale da 20m.
- ▶ 2 Cavi coassiali da 25m.
- ▶ Connettor1 V9144 F-maschio (11 pz)

SUPPLIED ACCESSORIES



▲ 50023/14 automatic gain control amplifier



▲ 50022/10 6 way line amplifier



▲ 20m (66') coaxial cable



▲ 25m (82') coaxial cable (2pcs)



▲ 1,5m (5') set cord



▲ V9144 F-male gold plated connector (11pcs)

OPTIONAL ACCESSORIES



▲ V9172 stainless steel mount



▲ V9148 3,6m (12') AM/FM radio cable



▲ V9147 2 way splitter (TV - TV/RADIO)

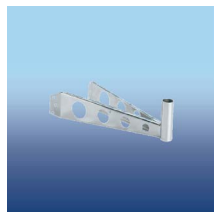

▲ V9173TV stainless steel masthead bracket



V9172

Micro-cast, electro-polished and hand-polished stainless steel mount for Nashira and Adhara TV antennas

Category: DVB-T2

Subcategories: Accessories

Code: V9172



V9172 is the new Glomex strong stainless steel mount, developed for perfect fitting in the new DVBT TV antennas Nashira (V9112AGCU/DAB20) and Adhara (V9150A-GC/DAB20).

This new mount is characterized by:

- ▶ High quality material
- ▶ micro-fused, electro-polished and hand-polished stainless steel
- ▶ Aerodynamic lines
- ▶ Innovative design
- ▶ Mounting by only two screws

Moreover, the new design well matches with those of Nashira and Adhara.

Glomex has developed this new mount for ensuring the best antenna's stability in any sea conditions.

For all of these reasons we suggest you to use V9172 as the mount of our Nashira and Adhara DVBT TV antennas.

- ▶ **Size:** 130mm (5") height / 25mm (1") diam.

 V9172 est le nouveau support exclusif Glomex en acier inoxydable Aisi 316, développé numériquement pour les nouvelles antennes TV terrestres Nashira (V9112AGCU / DAB20) et Adhara (V9150AGC / DAB202).

Le nouveau support se démarque de tous les autres sur le marché pour :

- ▶ Matériel de haute qualité
- ▶ Acier inoxydable Aisi 316 électropoli et poli à la main
Lignes aérodynamiques
- ▶ Conception innovante
- ▶ Fixation en surface avec seulement deux vis

Le V9172 a été conçu pour avoir un design attrayant qui correspond parfaitement au nouveau design des antennes TV Nashira et Adhara.

Enfin, ce support garantit une stabilité maximale de l'antenne dans toutes les conditions de navigation.

Pour toutes ces raisons, Glomex suggère d'utiliser le V9172 comme support idéal pour les nouvelles antennes TV Nashira et Adhara.

Dimensions: hauteur 130 mm / diamètre 25 mm.

 V9172 è il nuovo supporto esclusivo Glomex in acciaio inox Aisi 316, sviluppato appositamente per le nuove antenne TV per il digitale terrestre Nashira (V9112AGCU/DAB20) e Adhara (V9150AGC/DAB202).

Il nuovo supporto si distingue da tutti gli altri in commercio per:

- ▶ Materiale di alta qualità
- ▶ Acciaio inox Aisi 316 microfuso, elettrolucidato e lucidato a mano
- ▶ Linee aerodinamiche
- ▶ Design innovativo
- ▶ Fissaggio sulla superficie con solo due viti

Il V9172 è stato progettato per avere un design accattivante che si abbina perfettamente con il nuovo design delle antenne TV Nashira ed Adhara.

Questo supporto, infine, garantisce la massima stabilità dell'antenna in qualsiasi condizione di navigazione.

Per tutti questi motivi Glomex suggerisce l'utilizzo del V9172 come il supporto ideale per le nuove antenne TV Nashira ed Adhara.

- ▶ **Dimensioni:** altezza 130mm / diametro 25mm.

OPTIONAL ACCESSORIES

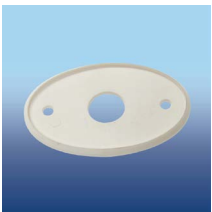

▲ V9102 rubber gasket



V9124

Stainless steel mount

Category: DVB-T2

Subcategories: Accessories

Code: V9124



🇬🇧 Stainless steel universal mount (diameter 25 mm/1" and height 150 mm/6")

🇫🇷 Support en acier inoxydable (diameter 25 mm / hauteur 150mm)

🇮🇹 Supporto universale in acciaio inossidabile (diametro 25 mm / 1" e altezza 150 mm / 6")

OPTIONAL ACCESSORIES

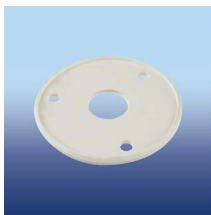

▲ V9101/W rubber gasket

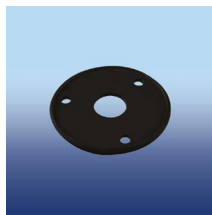

▲ V9101/B black rubber gasket



V9123

Masthead mount in stainless steel for Avior, Talitha AGC and Altair AGC. Long 16cm.

Category: DVB-T2

Subcategories: Accessories

Code: V9123



🇬🇧 Stainless steel masthead mount for Avior, Talitha AGC and Altair AGC, long 16cm.

🇫🇷 Support de tête de mât en acier inoxydable pour Avior, Talitha AGC et Altair AGC, long 16cm.

🇮🇹 Supporto in acciaio inox per testa d'albero per Avior, Talitha AGC e Altair AGC, lungo 16cm.

V9173TV

Stainless steel masthead mount for Nashira AGC and Adhara AGC, length 27cm.

Category: DVB-T2

Subcategories: Accessories

Code: V9173TV



 Stainless steel mount for Nashira AGC and Adhara AGC, 27cm.

 Support de tête de mât en acier inoxydable pour Nashira AGC et Adhara AGC, long 27cm.

 Supporto in acciaio inox per testa d'albero per Nashira AGC e Adhara AGC, lungo 27cm.

V9147

2 way splitter TV/TV or TV/FM for DVB-T2 TV antennas

Category: DVB-T2

Subcategories: Accessories

Code: V9147



 2-output TV/TV or TV/FM splitter for DVB-T2 TV antennas

 Splitter à deux sorties TV/TV ou TV/FM pour antenne TV DVB-T2

 Splitter a 2 uscite TV/TV or TV/FM per antenne TV DVB-T2



V9114PI-FM

Power inserter for VT300 Avior and RA304TV Alya with 2 outputs: TV/TV or TV/RADIO

Category: DVB-T2

Subcategories: Accessories

Code: V9114PI-FM



🇬🇧 Power supply for VT300 Avior and RA304TV Alya with 2 outputs: TV/TV or TV/RADIO

🇫🇷 Bloc d'alimentation de tension pour l'antenne VT300 Avior et RA304TV Alya avec 2 sorties: TV/TV ou TV/RADIO

🇮🇹 Alimentatore per VT300 Avior e RA304TV Alya con 2 uscite: TV/TV o TV/RADIO

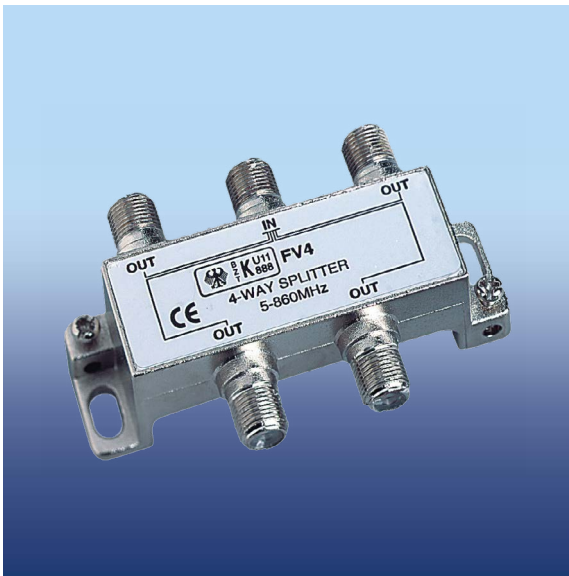

V9151

4 way splitter TV/TV or TV/FM for DVB-T2 TV antennas

Category: DVB-T2

Subcategories: Accessories

Code: V9151



🇬🇧 4-output TV/TV or TV/FM splitter for DVB-T2 TV antennas

🇫🇷 Splitter à quatre sorties TV/TV ou TV/FM pour antenne TV DVB-T2

🇮🇹 Splitter a 4 uscite TV/TV o TV/FM per antenne TV DVB-T2

V9148

Radio cable (3,6m/12") F male gold-plated connector to motorola plug

Category: DVB-T2

Subcategories: Accessories

Code: v9148



 Radio cable (3.6m) from gold-plated male f connector to motorola socket.

 Câble radio (3,6 m) du connecteur f mâle doré à la prise motorola.

 Cavo radio (3,6m) da connettore f maschio dorato a presa motorola.

v9149

2 way radio cable (200mm/8") from motorola jack to 2 motorola plugs

Category: DVB-T2

Subcategories: Accessories

Code: V9149

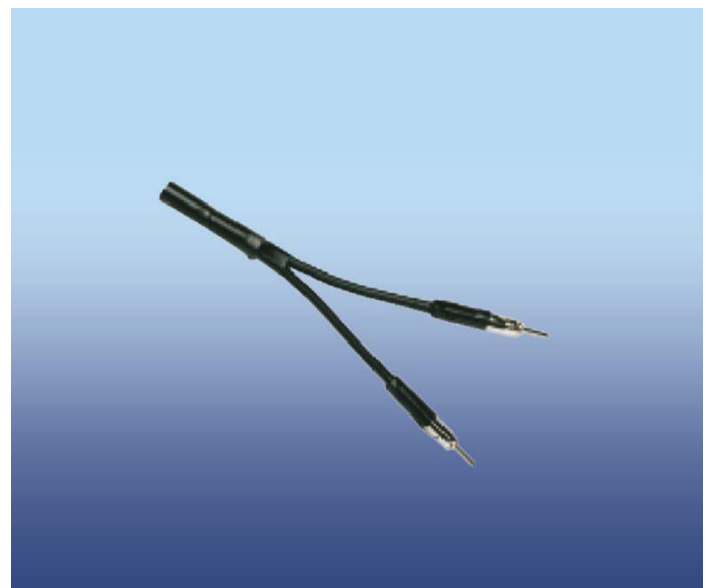

 2 way radio cable (200mm) from motorola jack to 2 motorola plugs for V9112 and V9130

 Câble radio 2 sorties (200mm) de la prise motorola à 2 prises motorola

 Cavo radio 2 uscite (200mm) da jack motorola a 2 prese motorola

50023/14

Automatic gain control amplifier for Glomex non pre-amplified DVB-T2 omnidirectional antennas - 12/24 Vdc

Category: DVB-T2

Subcategories: Amplifiers

Code: 50023/14

TALITHA

NASHIRA

ADHARA

AVIOR



The Automatic Gain Control Amplifier can be used with all Glomex non pre-amplified DVB-T2 omnidirectional antennas. This amplifier, compared to the previous one, has the following key points: Increases the performances on TV signal reception - Automatically control the signal gain - with 2 TV outputs or 1 TV and 1 FM radio output. Thanks to the new amplifier you have only to turn on the TV, stay comfortably seated on the sofa and enjoy your favourite programs. With conventional amplifiers, in fact, you have to manually adjust the TV signal gain by lowering the amplification when the signal is high and by increasing the amplification when the boat is at sea and far from the TV transmitter. With the new AGC amplifier, everything will happen automatically and it can be placed in a hidden location inside the boat.

Amplificateur avec contrôle automatique du gain pour les antennes Glomex TV DVB-T2 pas pré-amplifiée. Ce nouvel amplificateur, contrairement aux autres, a les avantages suivants: Augmenter les performances de réception d'antenne. Contrôle automatiquement le gain du signal. Avec 2 sorties pour TV ou 1 sortie pour TV et 1 sortie pour radio FM. Grâce à ce nouveau amplificateur il suffit d'allumer le téléviseur et de rester confortablement assis et profitez de vos programmes favoris, ce sera l'amplificateur qui réglera le gain du signal TV pour assurer à tout moment la meilleure réception possible des émissions de télévision. Avec un amplificateur classique, il était nécessaire d'intervenir manuellement sur l'amplificateur en réduisant l'amplification lorsque le signal TV est forte et en augmentant l'amplification lorsque le bateau été en mer et loin du répéteur de la télévision. Avec le nouvel amplificateur AGC, tout se fera automatiquement et il pourra être placé dans une position cachée du bateau.

Il nuovo amplificatore a controllo automatico del guadagno in dotazione all'antenna TV Nashira AGC può essere utilizzato anche con i modelli precedenti di Nashira (codici V9112/00, V9112/12, V9112/12AB e V9112/12EC) e TALITHA (codici V9125/12 e V9125/00) prodotti dal 1998. Questo nuovo amplificatore, a differenza dei precedenti ha i seguenti punti di forza: Incrementa le performance di ricezione dell'antenna. Controlla automaticamente il guadagno del segnale semplificandovi la vita. Con 2 uscite TV o 1 uscita TV e 1 uscita FM. Grazie al nuovo amplificatore non dovrete fare altro che accendere la TV e restare comodamente seduti a godervi i vostri programmi preferiti, sarà l'amplificatore a regolare il guadagno del segnale televisivo per garantirvi sempre e ovunque la migliore ricezione possibile delle trasmissioni televisive. Con i normali amplificatori, infatti, occorre intervenire manualmente nell'amplificatore abbassando l'amplificazione quando la barca è ancorata in marina e aumentando l'amplificazione quando la barca è in navigazione e lontana dai ripetitori TV. Con il nuovo amplificatore AGC, tutto ciò avverrà in automatico e potrà essere collocato in una posizione nascosta della barca. Alimentazione: 12/24 Vdc

CONNECTION SCHEME

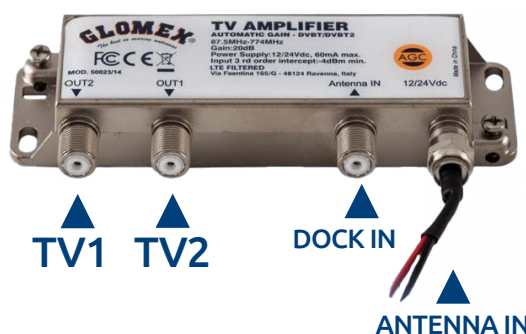

50023/14AB

Automatic a/b switch and automatic gain control amplifier for Glomex non pre-amplified DVB-T2 omnidirectional antennas - 12/24 Vdc

Category: DVB-T2

Subcategories: Amplifiers

Code: 50023/14AB

CALIHA ✨
NASHIRA ✨
ADHARA ✨
AVIOR ✨



🇬🇧 When you moor your boat and there is a dock TV antenna, you can easily connect your onboard TV system to the dock TV antenna. When the 50023/14AB amplifier finds the dock TV signal it automatically switches the signal reception from the Glomex TV antenna to the dock TV one. Moreover, this new amplifier, compared to the previous one, has the following key points: Increases the performances on TV signal reception - Automatically control the signal gain - with 2 TV outputs or 1 TV and 1 FM radio output. Thanks to the new amplifier you have only to turn on the TV, stay comfortably seated on the sofa and enjoy your favourite programs. With conventional amplifiers, in fact, you have to manually adjust the TV signal gain by lowering the amplification when the signal is high and by increasing the amplification when the boat is at sea and far from the TV transmitter. With the new AGC amplifier, everything will happen automatically and it can be placed in a hidden location inside the boat.

🇫🇷 Lorsque vous amarrez votre bateau et qu'il y a une antenne TV sur le dock, vous pouvez facilement connecter votre système TV embarqué à l'antenne TV sur le dock. Lorsque l'amplificateur 50023/14AB trouve le signal TV, il commutera automatiquement la réception du signal de l'antenne TV Glomex vers la station d'accueil TV. Ce nouvel amplificateur, en plus, contrairement aux autres, a les avantages suivants: Augmenter les performances de réception d'antenne. Contrôle automatiquement le gain du signal. Avec 2 sorties pour TV ou 1 sortie pour TV et 1 sortie pour radio FM. Grâce à ce nouveau amplificateur il suffit d'allumer le téléviseur et de rester confortablement assis et profitez de vos programmes favoris, ce sera l'amplificateur qui réglera le gain du signal TV pour assurer à tout moment la meilleure réception possible des émissions de télévision. Avec un amplificateur classique, il était nécessaire d'intervenir manuellement sur l'amplificateur en réduisant l'amplification lorsque le signal TV est forte et en augmentant l'amplification lorsque le bateau été en mer et loin du répéteur de la télévision. Avec le nouvel amplificateur AGC, tout se fera automatiquement et il pourra être placé dans une position cachée du bateau.

🇮🇹 Quando ormeggi la tua barca ed è presente un'antenna TV in banchina, puoi collegare facilmente il tuo sistema TV di bordo all'antenna TV della banchina. Quando l'amplificatore 50023/14AB trova il segnale TV, commuta automaticamente la ricezione del segnale dall'antenna TV Glomex a quella TV dock. Questo nuovo amplificatore, inoltre, a differenza dei precedenti ha i seguenti punti di forza: Incrementa le performance di ricezione dell'antenna. Controlla automaticamente il guadagno del segnale semplificandovi la vita. Con 2 uscite TV o 1 uscita TV e 1 uscita FM. Grazie al nuovo amplificatore non dovrete fare altro che accendere la TV e restare comodamente seduti a godervi i vostri programmi preferiti, sarà l'amplificatore a regolare il guadagno del segnale televisivo per garantirvi sempre e ovunque la migliore ricezione possibile delle trasmissioni televisive. Con i normali amplificatori, infatti, occorre intervenire manualmente nell'amplificatore abbassando l'amplificazione quando la barca è ancorata in marina e aumentando l'amplificazione quando la barca è in navigazione e lontana dai ripetitori TV. Con il nuovo amplificatore AGC, tutto ciò avverrà in automatico e potrà essere collocato in una posizione nascosta della barca. Alimentazione: 12/24 Vdc



50022/10

6 outputs line amplifier for Adhara AGC - 12/24Vdc

Category: DVB-T2

Subcategories: Amplifiers

Code: 50022/10



🇬🇧 The amplifier is a device allowing you to monitor the antenna gain, expressed in dB, by adjusting intensity of the signal input or output. Generally the amplifier allows the adjustment of the signal power in order to optimize the reception: it amplifies the weaker signals or dramps the stronger ones. The 50022/10 is both a line amplifier and a splitter, that allows to connect up to 6 TV set, without losing quality signal.

🇫🇷 L'amplificateur est un dispositif qui permet de contrôler le gain de l'antenne, exprimé en dB, en ajustant l'intensité de la réception ou de la transmission du signal. En général, l'amplificateur permet de régler la puissance du signal, afin d'optimiser sa réception: il amplifie les signaux les plus faibles ou atténue les plus forts. Le 50022/10 est soit un amplificateur que un répartiteur qui permet de connecter jusqu'à 6 télévisions, sans perte de qualité de signaux.

🇮🇹 L'amplificatore è un dispositivo che consente di controllare il guadagno dell'antenna, espresso in dB, aggiustando l'intensità del segnale in ingresso o in uscita. In generale, l'amplificatore consente di regolare la potenza del segnale al fine di ottimizzare la ricezione: amplificare i segnali più deboli o attenuare quelli più forti. Il 50022/10 è sia un amplificatore che un ripartitore che consente di collegare fino a 6 televisori, senza perdita di qualità del segnale.

CONNECTION SCHEME

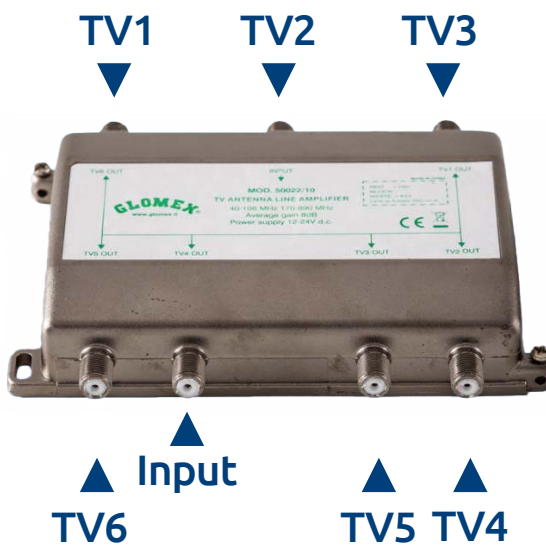





MAKO

250 mm (10") white 3db small deck and regatta vhf fast fitting glomeasy antenna

Category: VHF

Subcategory: 250mm (10")

Code: RA130 RA130/BK



🇬🇧 The new MAKO is a short-range, fin-shaped Marine VHF Antenna. Low profile for modern mid-sized powerboats and RIBS. The case is made of polycarbonate/ASA, the best compound for this sealed body to resist for a long time in the harsh marine environment.

- ▶ For communication up to 12 nm range
- ▶ Waterproof body with double rubber gasket integrated on the base
- ▶ Compact dimensions 140x70x61mm (5,5x2,7x2,4")
- ▶ GLOMEX Lifetime warranty
- ▶ 8mt/26 ft coaxial cable and connectors supplied
- ▶ Available in white (mod. RA130), black (mod. RA130/BK)



▲ 8m/26ft COAXIAL CABLE

La nouvelle MAKO est une antenne VHF marine à courte portée, en forme d'aile.
Antenne VHF marine à courte portée, en forme d'aile.
Profil bas pour les bateaux à moteur modernes de taille moyenne et les RIBS. Le boîtier est en polycarbonate/ASA, le meilleur composé pour cette le meilleur composé pour que ce corps scellé résiste longtemps dans l'environnement marin difficile.

- ▶ Pour les communications jusqu'à une portée de 12 nm
- ▶ Boîtier étanche avec double joint en caoutchouc intégré à la base
- ▶ Dimensions compactes 140x70x61mm (5,5x2,7x2,4")
- ▶ Garantie GLOMEX à vie
- ▶ Câble coaxial de 8m/26 ft et connecteurs fournis
- ▶ Disponible en blanc (mod. RA130), noir (mod. RA130/BK)

Il nuovo MAKO è un'antenna VHF marina a corto raggio e a forma di pinna.
Antenna VHF marina a corto raggio. Basso profilo per le moderne imbarcazioni a motore di medie dimensioni e per i RIBS. L'involucro è realizzato in polycarbonato/ASA, il migliore per questo corpo sigillato per resistere a lungo per resistere a lungo nel difficile ambiente marino.

- ▶ Per comunicazioni fino a 12 nm di distanza
- ▶ Corpo impermeabile con doppia guarnizione in gomma integrata nella base
- ▶ Dimensioni compatte 140x70x61 mm (5,5x2,7x2,4")
- ▶ Garanzia a vita GLOMEX
- ▶ Cavo coassiale da 8m/26 ft e connettori in dotazione
- ▶ Disponibile in bianco (mod. RA130), nero (mod. RA130/BK)

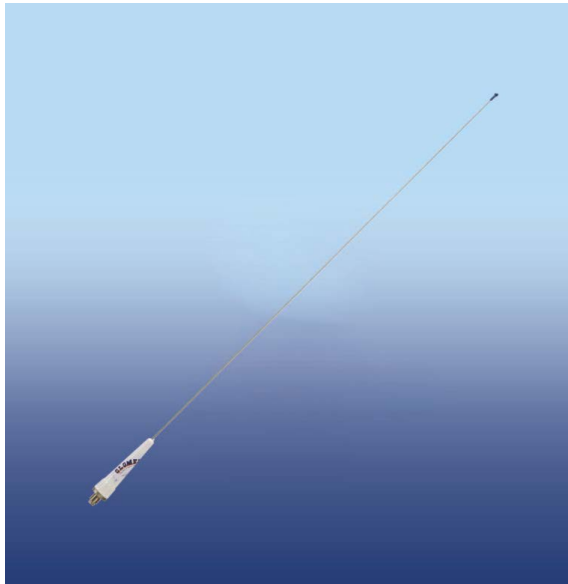

RA106SLSPB

900mm (35") VHF antenna with stainless steel whip

Category: VHF

Subcategories: Aloud series

Code: RA106SLSPB



🇬🇧 The RA106 series antennas are reliable and solid, ideal for any type of boat, whether a sailboat or a motorboat and for tenders as well (version RIB). RA106SLSPB is a VHF antenna designed for motorboats, thanks to the tapered stainless steel rod which can absorb extreme forces without damage. It's equipped with Glomex "RA106 solderless" special connector, waterproof and solderless, easing the installation.

Supplied accessories:

- ▶ PL259 male nichel-plated connector (code RA132).
- ▶ Pvc rubber protection for connector (code RA138).
- ▶ Nylon feed-thru (code RA140).
- ▶ Stainless steel adaptor. Standard 1"x14 thread (code RA106ADAPT1X14)

FREQUENCY RANGE	156/162 MHz
GAIN AVERAGE	3dB
IMPEDANCE	50 ohms
POLARIZATION	Vertical
SWR	≤ 1,3 at 156,8 MHz
MAX IMPUT POWER	100 W
DC GROUND	yes
LENGHT	900mm/35"
WEIGHT	180g/6,35oz
TERMINATION	RA106 solderless connector
<i>More info on www.glomex.it</i>	

Les antennes de la série RA106 sont fiables et solides, idéales pour tout type de bateau, à voile et à moteur, mais aussi pour des « Zodiacs » et autres bateaux pneumatiques (version RIB). RA106SLSPB est une antenne VHF conçue pour être installée sur les bateaux à moteur, parce que le fouet conique en acier inoxydable peut absorber les fluctuations sans subir de dommages. Elles sont toutes équipées du connecteur spécial Glomex "RA106 solderless" étanche et sans soudure pour en faciliter l'installation.

Accessoires inclus:

- ▶ connecteur PL259 male nichelato (code RA132)
- ▶ protection pour connecteur (code RA138)
- ▶ pass-fil en nylon (code RA140)
- ▶ adaptateur en acier inoxydable electro-poli filetage standard 1"x14 (code RA106ADAPT1X14)

Le antenne della serie RA106 sono affidabili e robuste, ideali per tutti i tipi d'imbarcazione a vela, a motore e per i gommoni (versioni RIB). RA106SLSPB è un'antenna VHF destinata alle barche a motore, in quanto lo stilo in acciaio inox Aisi 316 conificato può assorbire qualsiasi fluttuazione senza subire danni. È dotata dello speciale connettore stagno Glomex "RA106 solderless", impermeabile e senza saldatura, che ne facilita l'installazione.

Prodotti inclusi con l'antenna:

- ▶ connettore PL259 maschio nichelato (codice RA132).
- ▶ Protezione in gomma per connettore (codice RA138).
- ▶ Passacavo in nylon (codice RA140).
- ▶ Adattatore in acciaio inox elettrolucidato. Filettatura standard 1"x14 (codice RA106ADAPT1X14).

SUPPLIED ACCESSORIES



▲ RA132 PL259 male nickel-plated connector



▲ RA138 pvc rubber protection for connector



▲ RA140 nylon feed-thru

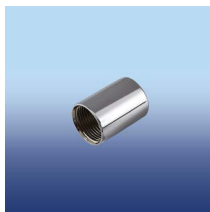

▲ RA106ADAPT1X14 1"x14 stainless steel adaptor.

OPTIONAL ACCESSORIES



▲ RA201 VHF/AM-FM/AIS splitter



▲ RA135 Nylon 4 way ratchet mount with knob



RA106GRPPB

900mm (35") VHF antenna with glossy fibreglass whip

Category: VHF

Subcategories: Aloud series

Code: RA106GRPPB



🇬🇧 The RA106 series antennas are reliable and solid, ideal for any type of boat, whether a sailboat or a motorboat and for tenders as well (version RIB). RA106GRPPB is a VHF antenna designed for motorboats with a fibreglass rod which takes advantage of white polyurethane paint, assuring a total protection of the antennas' inside copper components. It's equipped with Glomex "RA106 solderless" special connector, waterproof and solderless, easing the installation.

Supplied accessories:

- ▶ PL259 male nichel-plated connector (code RA132)
- ▶ pvc rubber protection for connector (code RA138)
- ▶ nylon feed-thru (code RA140)
- ▶ Stainless steel adaptor. Standard 1"x14 thread (code RA106 ADAPT 1X14)

FREQUENCY RANGE	156/162 MHz
GAIN AVERAGE	3dB
IMPEDANCE	50 ohms
POLARIZATION	Vertical
SWR	≤ 1,3 at 156,8 MHz
MAX IMPUT POWER	100 W
DC GROUND	yes
LENGHT	1m/3"
WEIGHT	900mm/35"
TERMINATION	RA106 solderless connector
<i>More info on www.glomex.it</i>	

Les antennes de la série RA106 sont fiables et solides, idéales pour tout type de bateau, à voile et à moteur, mais aussi pour des « Zodiacs » et autres bateaux pneumatiques (version RIB). RA106GRPPB est une antenne VHF conçue pour être installée sur les bateaux à moteur avec le fouet en fibre de verre qui, grâce à une peinture polyuréthane de couleur blanche, assurant une protection totale aux composants en cuivre situés à l'intérieur de l'antenne. Elles sont toutes équipées du connecteur spécial Glomex "RA106 solderless" étanche et sans soudure pour en faciliter l'installation.

Accessoires inclus:

- ▶ connecteur PL259 male nichelé (code RA132)
- ▶ protection pour connecteur (code RA138)
- ▶ pass-fil en nylon (code RA140)
- ▶ adaptateur en acier inoxydable electro-poli filetage standard 1"x14 (code RA106ADAPT1X14)

Le antenne della serie RA106 sono affidabili e robuste, ideali per tutti i tipi d'imbarcazione a vela, a motore e per i gommoni (versioni RIB). RA106GRPPB è un'antenna VHF destinata alle barche a motore, con stilo in fibra di vetro che dispone di una verniciatura poliuretana di colore bianco che assicura la protezione totale dei componenti di rame interni. È dotata dello speciale connettore stagno Glomex "RA106 solderless", impermeabile e senza saldatura, che ne facilita l'installazione.

Prodotti inclusi con l'antenna:

- ▶ connettore PL259 maschio nichelato (codice RA132).
- ▶ Protezione in gomma per connettore (codice RA138).
- ▶ Passacavo in nylon (codice RA140).
- ▶ Adattatore in acciaio inox elettrolucidato. Filettatura standard 1"x14 (codice RA106ADAPT1X14).

SUPPLIED ACCESSORIES



▲ RA132 PL259 male nickel-plated connector



▲ RA138 pvc rubber protection for connector



▲ RA140 nylon feed-thru

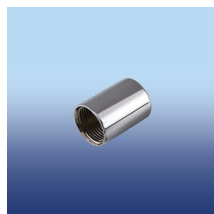

▲ RA106ADAPT1X14 1"x14 stainless steel adaptor.

OPTIONAL ACCESSORIES



▲ RA201 VHF/AM-FM/AIS splitter



▲ RA135 Nylon 4 way ratchet mount with knob

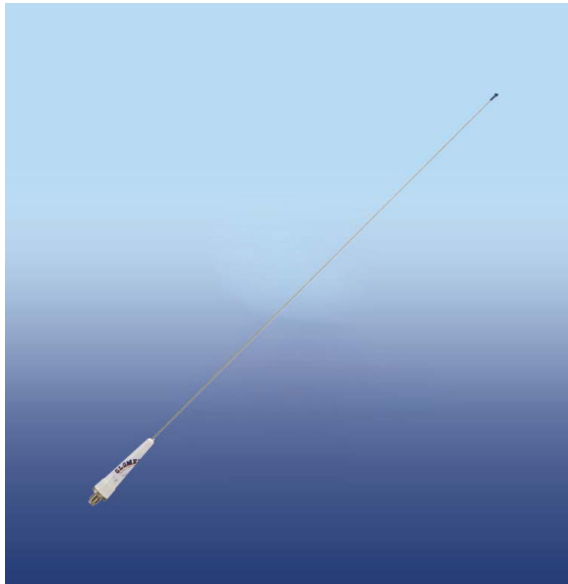

RA106SLSPB6135

900mm (35") VHF antenna with stainless steel whip, 4,5m (15') coax cable and 4 way nylon ratchet mount

Category: VHF

Subcategories: Aloud series

Code: RA106SLSPB6135



🇬🇧 The ra106 series antennas are reliable and solid, ideal for any type of boat, whether a sailboat or a motorboat and for tenders as well (version rib). Ra106slspb6135 is a vhf antenna designed for motorboats, thanks to the tapered stainless steel rod which can absorb extreme forces without damage. It's equipped with glomex "ra106 solderless" special connector, waterproof and solderless, easing the installation.

Supplied accessories:

- ▶ coaxial cable 4,5m/15' RG58ALL
- ▶ PL259 male nichel-plated connector (code RA132)
- ▶ pvc rubber protection for connector (code RA138)
- ▶ nylon feed-thru (code RA140)
4 way ratchet mount in reinforced nylon uv resistant, with knob, for deck or bulkhead:
- ▶ With hole for gps and feed-trhu for coax cable.
- ▶ Stainless steel adaptor. Standard 1"x14 thread (code RA106ADAPT1X14)
- ▶ Nylon 4 way ratchet mount with knob. Standard 1"x14 thread (code RA135)

FREQUENCY RANGE	156/162 MHz
GAIN AVERAGE	3dB
IMPEDANCE	50 ohms
POLARIZATION	Vertical
SWR	≤ 1,3 at 156,8 MHz
MAX IMPUT POWER	100 W
DC GROUND	yes
LENGHT	900mm/35"
WEIGHT	180g/6,35oz
TERMINATION	RA106 solderless connector
<i>More info on www.glomex.it</i>	

Les antennes de la série RA106 sont fiables et solides, idéales pour tout type de bateau, à voile et à moteur, mais aussi pour des « Zodiacs » et autres bateaux pneumatiques (version RIB). RA106SLSPB est une antenne VHF conçue pour être installée sur les bateaux à moteur, parce que le fouet conique en acier inoxydable peut absorber les fluctuations sans subir de dommages. Elles sont toutes équipées du connecteur spécial Glomex "RA106 solderless" étanche et sans soudure pour en faciliter l'installation.

Accessoires inclus:

- ▶ câble coaxial 4,5m RG58ALL.
- ▶ Connecteur PL259 male nichelé (code RA132)
- ▶ protection pour connecteur (code RA138)
- ▶ pass-fil en nylon (code RA140)
- ▶ Support en nylon avec double articulation avec blocage par molette (code RA135).
- ▶ Adaptateur en acier inoxydable electro-poli - filetage standard 1"x14 (code RA106ADAPT1X14)

Le antenne della serie RA106 sono affidabili e robuste, ideali per tutti i tipi d'imbarcazione a vela, a motore e per i gommoni (versioni RIB). RA106SLSPB6135 è un'antenna VHF destinata alle barche a motore, in quanto lo stilo in acciaio inox conifcato Aisi 316 può assorbire qualsiasi fluttuazione senza subire danni. È dotata dello speciale connettore stagno Glomex "RA106 solderless", impermeabile e senza saldatura, che ne facilita l'installazione.

Prodotti inclusi con l'antenna:

- ▶ cavo coassiale da 4,5m RG58ALL.
- ▶ Connettore PL259 maschio nichelato (codice RA132).
- ▶ Protezione in gomma per connettore (codice RA138).
- ▶ Passacavo in nylon (codice RA140).
- ▶ Base a doppio snodo in nylon con bloccaggio a pomello (codice RA135).
- ▶ Con foro per cavo gps e passacavo per gps.
- ▶ Filettatura standard 1"x14 (codice RA135).
- ▶ Adattatore in acciaio inox elettrolucidato aisi 316.
- ▶ Filettatura standard 1"x14 (codice RA106ADAPT1X14)

SUPPLIED ACCESSORIES



▲ RG58ALL 4,5m (59') coax cable



▲ RA132 PL259 male nichel-plated connector



▲ RA138 pvc rubber protection for connector



▲ RA140 nylon feed-thru

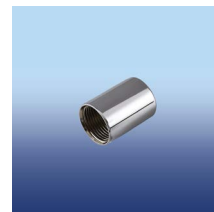

▲ RA106ADAPT1X14 1"x14 stainless steel adaptor.



▲ RA135 Nylon 4 way ratchet mount with knob

OPTIONAL ACCESSORIES



▲ RA201 VHF/AM-FM/AIS splitter



RA106GRPPB6135

900mm (35") VHF antenna with glossy fibreglass whip, 4,5m (15') coax cable and 4 way nylon ratchet mount

Category: VHF

Subcategories: Aloud series

Code: RA106GRPPB6135



🇬🇧 The RA106 series antennas are reliable and solid, ideal for any type of boat, whether a sailboat or a motorboat and for tenders as well (version RIB). RA106GRPPB6135 is a VHF antenna designed for motorboats with fibreglass rod which takes advantage of white polyurethane paint, assuring a total protection of the antennas' inside copper components. It's equipped with Glomex "RA106 solderless" special connector, waterproof and solderless, easing the installation.

Supplied accessories:

- ▶ coaxial cable - 4,5m/15' RG58ALL.
- ▶ PL259 male nichel-plated connector (code RA132).
- ▶ Pvc rubber protection for connector (code ra138).
- ▶ Nylon feed-thru (code RA140).
- ▶ 4 Way ratchet mount in reinforced nylon uv resistant, with knob, for deck or bulkhead.
- ▶ With hole for gps and feed-trhu for coax cable.
- ▶ Stainless steel adaptor. Standard 1"x14 thread (code RA106ADAPT1X14).
- ▶ Nylon 4 way ratchet mount with knob. Standard 1"x14 thread (code RA135).

FREQUENCY RANGE	156/162 MHz
GAIN AVERAGE	3dB
IMPEDANCE	50 ohms
POLARIZATION	Vertical
SWR	≤ 1,3 at 156,8 MHz
MAX IMPUT POWER	100 W
DC GROUND	yes
LENGHT	900mm/35"
WEIGHT	180g/6,35oz
TERMINATION	RA106 solderless connector
<i>More info on www.glomex.it</i>	

Les antennes de la série RA106 sont fiables et solides, idéales pour tout type de bateau, à voile et à moteur, mais aussi pour des « Zodiacs » et autres bateaux pneumatiques (version RIB). RA106GRPPB6135 est une antenne VHF conçue pour être installée sur les bateaux à moteur avec le fouet en fibre de verre qui, grâce à une peinture polyuréthane de couleur blanche, assurant une protection totale aux composants en cuivre situés à l'intérieur de l'antenne. Elles sont toutes équipées du connecteur spécial Glomex "RA106 solderless" étanche et sans soudure pour en faciliter l'installation.

Accessoires inclus:

- ▶ câble coaxial 4,5m RG58ALL connecteur PL259 male nichelé (code RA132)
- ▶ protection pour connecteur (code RA138)
- ▶ pass-fil en nylon (code RA140)
- ▶ Support en nylon avec double articulation avec blocage par molette (code RA135).
- ▶ adaptateur en acier inoxydable electro poli - filetage standard 1"x14 (code RA106ADAPT1X14)

Le antenne della serie RA106 sono affidabili e robuste, ideali per tutti i tipi d'imbarcazione a vela, a motore e per i gommoni (versioni RIB). RA106GRPPB6135 è un'antenna VHF destinata alle barche a motore, con stilo in fibra di vetro che dispone di una verniciatura poliuretano di colore bianco che assicura la protezione totale dei componenti di rame interni. È dotata dello speciale connettore stagno Glomex "RA106 solderless", impermeabile e senza saldatura, che ne facilita l'installazione.

Prodotti inclusi con l'antenna:

- ▶ cavo coassiale da 4,5m RG58ALL.
- ▶ Connettore PL259 maschio nichelato (codice RA132).
- ▶ Protezione in gomma per connettore (codice RA138).
- ▶ Passacavo in nylon (codice RA140).
- ▶ Base a doppio snodo in nylon con bloccaggio a pomello (codice RA135).
- ▶ Con foro per cavo gps e passacavo per gps.
- ▶ Filettatura standard 1"x14 (codice RA135).
- ▶ Adattatore in acciaio inox elettrolucidato. Filettatura standard 1"x14 (codice RA106ADAPT1X14).

SUPPLIED ACCESSORIES



▲ RG58ALL 4,5m (59') coax cable



▲ RA132 PL259 male nickel-plated connector



▲ RA138 pvc rubber protection for connector



▲ RA140 nylon feed-thru

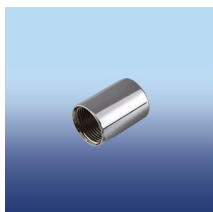

▲ RA106ADAPT1X14 1"x14 stainless steel adaptor.



▲ RA135 Nylon 4 way ratchet mount with knob

OPTIONAL ACCESSORIES



▲ RA201 VHF/AM-FM/AIS splitter

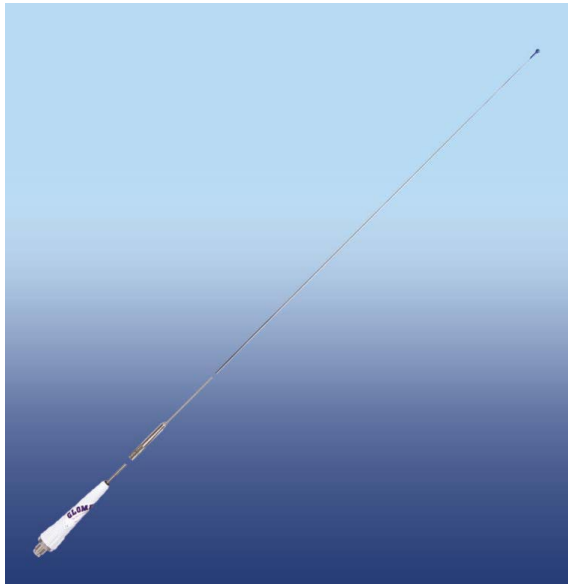

RA106SLSRIB

900mm (35") VHF antenna for R.I.B. with unscrewable stainless steel whip

Category: VHF

Subcategories: Aloud series

Code: RA106SLSRIB



🇬🇧 The RA106 series antennas are reliable and solid, ideal for any type of boat, whether a sailboat or a motorboat and for tenders as well (version RIB). RA106SLSRIB is a VHF antenna designed for inlatables RIB, thanks to the tapered stainless steel rod which can absorb extreme forces without damage. It's equipped with Glomex "RA106 solderless" special connector, waterproof and solderless, easing the installation.

Supplied accessories:

- ▶ coaxial cable 4,5m/15' RG58ALL
- ▶ PL259 male nichel-plated connector (code ra132)
- ▶ pvc rubber protection for connector (code RA138)
- ▶ nylon feed-thru (code RA140)
- ▶ Nylon 4 way ratchet mount with knob. Standard 1"x14 thread (code RA135).
- ▶ Stainless steel adaptor. Standard 1"x14 thread (code RA106ADAPT1X14).

FREQUENCY RANGE	156/162 MHz
GAIN AVERAGE	3dB
IMPEDANCE	50 ohms
POLARIZATION	Vertical
SWR	≤ 1,3 at 156,8 MHz
MAX IMPUT POWER	100 W
DC GROUND	yes
LENGHT	900mm/35"
WEIGHT	180g/6,35oz
TERMINATION	RA106 solderless connector
<i>More info on www.glomex.it</i>	

Les antennes de la série RA106 sont fiables et solides, idéales pour tout type de bateau, à voile et à moteur, mais aussi pour des « Zodiacs » et autres bateaux pneumatiques (version RIB). RA106SLSRIB est une antenne VHF conçue pour être installée sur des « Zodiacs » et autres bateaux pneumatiques, parce que le fouet conique en acier inoxydable peut absorber les fluctuations sans subir de dommages. Elles sont toutes équipées du connecteur spécial Glomex "RA106 solderless" étanche et sans soudure pour en faciliter l'installation.

Accessoires inclus:

- ▶ câble coaxial 4,5m RG58all.
- ▶ Connecteur PL259 male nichelé (code RA132)
- ▶ protection pour connecteur (code RA138)
- ▶ pass-fil en nylon (code RA140)
- ▶ Support en nylon avec double articulation avec blocage par molette (code RA135).
- ▶ Adaptateur en acier inoxydable electro-poli-filetage standard 1"x14 (code RA106ADAPT1X14)

Le antenne della serie RA106 sono affidabili e robuste, ideali per tutti i tipi d'imbarcazione a vela, a motore e per i gommoni (versioni RIB). RA106SLSRIB è un'antenna VHF destinata ai gommoni, in quanto lo stilo in acciaio inox conificato Aisi 316 può assorbire qualsiasi fluttuazione senza subire danni. È dotata dello speciale connettore stagno Glomex "RA106 solderless", impermeabile e senza saldatura, che ne facilita l'installazione.

Prodotti inclusi con l'antenna:

- ▶ cavo coassiale da 4,5m RG58ALL.
- ▶ Connettore PL259 maschio nichelato (codice RA132).
- ▶ Protezione in gomma per connettore (codice RA138).
- ▶ Passacavo in nylon (codice RA140).
- ▶ Base a doppio snodo in nylon con bloccaggio a pomello (codice RA135).
- ▶ Adattatore in acciaio inox elettrolucidato. Filettatura standard 1"x14 (codice RA106ADAPT1X14).

SUPPLIED ACCESSORIES



▲ RG58ALL 4,5m (59') coax cable



▲ RA132 PL259 male nichel-plated connector



▲ RA138 pvc rubber protection for connector



▲ RA140 nylon feed-thru

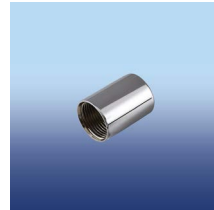

▲ RA106ADAPT1X14 1"x14 stainless steel adaptor.



▲ RA135 Nylon 4 way ratchet mount with knob

OPTIONAL ACCESSORIES



▲ RA201 VHF/AM-FM/AIS splitter

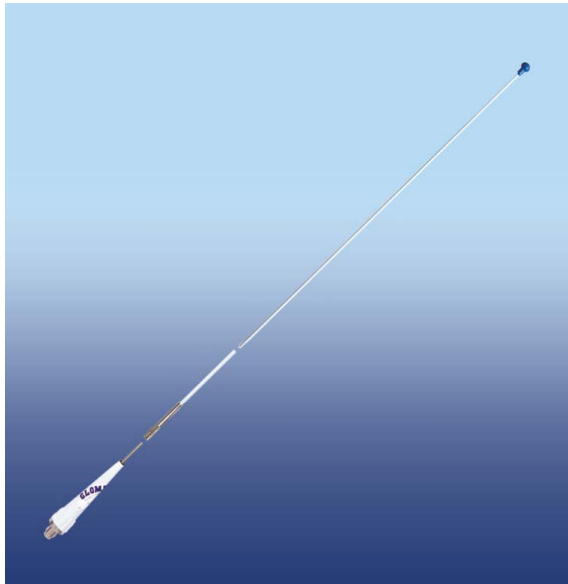

RA106GRPRIB

900mm (35") VHF antenna for R.I.B. with glossy fibreglass whip

Category: VHF

Subcategories: Aloud series

Code: RA106GRPRIB



🇬🇧 The RA106 series antennas are reliable and solid, ideal for any type of boat, whether a sailboat or a motorboat and for tenders as well (version RIB). RA106GRPRIB is a VHF antenna designed for iflatables RIB with a fibreglass rod which takes advantage of white polyurethane paint, assuring a total protection of the antennas' inside copper components. It's equipped with Glomex "RA106 solderless" special connector, waterproof and solderless, easing the installation.

Supplied accessories:

- ▶ coaxial cable 4,5m/15' RG58ALL
- ▶ PL259 male nichel-plated connector (code ra132)
- ▶ pvc rubber protection for connector (code RA138)
- ▶ nylon feed-thru (code RA140)
- ▶ Nylon 4 way ratchet mount with knob. Standard 1"x14 thread (code RA135)
- ▶ Stainless steel adaptor. Standard 1"x14 thread (code RA106ADAPT1X14)

FREQUENCY RANGE	156/162 MHz
GAIN AVERAGE	3dB
IMPEDANCE	50 ohms
POLARIZATION	Vertical
SWR	≤ 1,3 at 156,8 MHz
MAX IMPUT POWER	100 W
DC GROUND	yes
LENGHT	900mm/35"
WEIGHT	180g/6,35oz
TERMINATION	RA106 solderless connector
<i>More info on www.glomex.it</i>	

Les antennes de la série RA106 sont fiables et solides, idéales pour tout type de bateau, à voile et à moteur, mais aussi pour des « Zodiacs » et autres bateaux pneumatiques (version RIB). RA106GRPRIB est une antenne VHF conçue pour être installée sur les « Zodiacs » et autres bateaux pneumatiques avec le fouet en fibre de verre qui, grâce à une peinture polyuréthane de couleur blanche, assurant une protection totale aux composants en cuivre situés à l'intérieur de l'antenne. Elles sont toutes équipées du connecteur spécial Glomex "RA106 solderless" étanche et sans soudure pour en faciliter l'installation.

Accessoires inclus:

- ▶ câble coaxial 4,5m RG58ALL.
- ▶ Connecteur PL259 male nichelé (code RA132).
Protection pour connecteur (code RA138).
- ▶ Pass-fil en nylon (code RA140).
- ▶ Support en nylon avec double articulation avec blocage par molette (code RA135).
- ▶ Adaptateur en acier inoxydable electro-poli-filetage standard 1"x14 (RA106ADAPT1X14).

Le antenne della serie RA106 sono affidabili e robuste, ideali per tutti i tipi d'imbarcazione a vela, a motore e per i gommoni (versioni RIB). RA106GRPRIB è un'antenna VHF destinata ai gommoni, con stilo in fibra di vetro che dispone di una verniciatura poliuretanic di colore bianco che assicura la protezione totale dei componenti di rame interni. È dotata dello speciale connettore stagno Glomex "RA106 solderless", impermeabile e senza saldatura, che ne facilita l'installazione.

Prodotti inclusi con l'antenna:

- ▶ cavo coassiale da 4,5m RG58ALL.
- ▶ Connettore PL259 maschio nichelato (codice RA132).
- ▶ Protezione in gomma per connettore (codice RA138).
- ▶ Passacavo in nylon (codice RA140).
- ▶ Base a doppio snodo in nylon con bloccaggio a pomello (codice RA135).
- ▶ Adattatore in acciaio inox elettrolucidato. Filettatura standard 1"x14 (codice RA106ADAPT1X14).

SUPPLIED ACCESSORIES



▲ RG58ALL 4,5m (59') coax cable



▲ RA132 PL259 male nichel-plated connector



▲ RA138 pvc rubber protection for connector



▲ RA140 nylon feed-thru

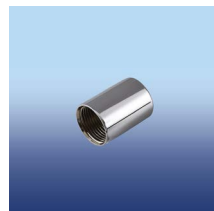

▲ RA106ADAPT1X14 1"x14 stainless steel adaptor.



▲ RA135 Nylon 4 way ratchet mount with knob

OPTIONAL ACCESSORIES



▲ RA201 VHF/AM-FM/AIS splitter



RA106SLSSB18

900mm (35") VHF antenna for sail boat with stainless steel whip, 18m (59') coax cable and masthead bracket

Category: VHF

Subcategories: Aloud series

Code: RA106SLSSB18



🇬🇧 The RA106 series antennas are reliable and solid, ideal for any type of boat, whether a sailboat or a motorboat and for tenders as well (version RIB). RA106SLSSB18 is a VHF antenna designed for sailboats with the tapered stainless steel rod which can absorb extreme forces without damage. It's equipped with Glomex "RA106 solderless" special connector, waterproof and solderless, easing the installation.

Supplied accessories:

- ▶ coaxial cable - 18m/59' RG58ALL.
- ▶ PL259 male nichel-plated connector (code ra132).
- ▶ Pvc rubber protection for connector (code RA138).
- ▶ Nylon feed-thru (code RA140).
- ▶ Electropolished stainless steel masthead bracket (code RA106BRACKINOX)

FREQUENCY RANGE	156/162 MHz
GAIN AVERAGE	3dB
IMPEDANCE	50 ohms
POLARIZATION	Vertical
SWR	≤ 1,3 at 156,8 MHz
MAX IMPUT POWER	100 W
DC GROUND	yes
LENGHT	900mm/35"
WEIGHT	180g/6,35oz
TERMINATION	RA106 solderless connector
<i>More info on www.glomex.it</i>	

Les antennes de la série RA106 sont fiables et solides, idéales pour tout type de bateau, à voile et à moteur, mais aussi pour des « Zodiacs » et autres bateaux pneumatiques (version RIB). RA106SLSSB18 est une antenne VHF conçue pour être installée sur les bateaux à voile, avec le fouet conique en acier inoxydable qui peut absorber les fluctuations sans subir de dommages. Elles sont toutes équipées du connecteur spécial Glomex "RA106 solderless" étanche et sans soudure pour en faciliter l'installation.

Accessoires inclus:

- ▶ câble coaxial 25m RG58ALL.
- ▶ Connecteur PL259 male nichelé (code RA132).
- ▶ Protection pour connecteur (code RA138).
- ▶ Pass-fil en nylon (code RA140).
- ▶ Support en acier inoxydable electro-poli pour installation sur tête de mât (code RA106BRACKINOX).

Le antenne della serie RA106 sono affidabili e robuste, ideali per tutti i tipi d'imbarcazione a vela, a motore e per i gommoni (versioni RIB). RA106SLSSB18 è un'antenna VHF destinata all'installazione su barche a vela con lo stilo in acciaio inox conificato Aisi 316 che può assorbire qualsiasi fluttuazione senza subire danni. È dotata dello speciale connettore stagno Glomex "RA106 solderless", impermeabile e senza saldatura, che ne facilita l'installazione.

Prodotti inclusi con l'antenna:

- ▶ cavo coassiale da 18m RG58ALL.
- ▶ Connettore PL259 maschio nichelato (codice RA132).
- ▶ Protezione in gomma per connettore (codice RA138).
- ▶ Passacavo in nylon (codice RA140).
- ▶ Staffa in acciaio inox elettrolucidato aisi 316 per installazione in testa d'albero. (Codice RA106BRACKINOX).

SUPPLIED ACCESSORIES



▲ RG58ALL 18m (59') coax cable



▲ RA132 PL259 male nickel-plated connector



▲ RA138 pvc rubber protection for connector



▲ RA140 nylon feed-thru



▲ RA106BRACKINOX stainless steel masthead bracket

OPTIONAL ACCESSORIES



▲ RA201 VHF/AM-FM/AIS splitter

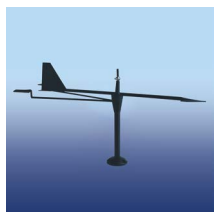

▲ RA179 wind indicator



RA106GRPSB18

900mm (35") VHF antenna for sail boat with glossy fibre-glass whip, 18m (59') coax cable and masthead bracket

Category: VHF

Subcategories: Aloud series

Code: RA106GRPSB18



🇬🇧 The RA106 series antennas are reliable and solid, ideal for any type of boat, whether a sailboat or a motorboat and for tenders as well (version RIB). RA106GRPSB18 is a VHF antenna designed for sailboats with a fibre-glass rod which takes advantage of white polyurethane paint, assuring a total protection of the antennas' inside copper components. It's equipped with Glomex "RA106 solderless" special connector, waterproof and solderless, easing the installation.

Supplied accessories:

- ▶ coaxial cable - 18m/59' RG58ALL - PL259
- ▶ male nichel-plated connector (code RA132)
- ▶ pvc rubber protection for connector (code RA138)
- ▶ nylon feed-thru (code RA140)
- ▶ electropolished stainless steel masthead bracket (code RA106BRACKINOX)

FREQUENCY RANGE	156/162 MHz
GAIN AVERAGE	3dB
IMPEDANCE	50 ohms
POLARIZATION	Vertical
SWR	≤ 1,3 at 156,8 MHz
MAX IMPUT POWER	100 W
DC GROUND	yes
LENGHT	900mm/35"
WEIGHT	180g/6,35oz
TERMINATION	RA106 solderless connector
<i>More info on www.glomex.it</i>	

Les antennes de la série RA106 sont fiables et solides, idéales pour tout type de bateau, à voile et à moteur, mais aussi pour des « Zodiacs » et autres bateaux pneumatiques (version RIB). RA106GRPSB18 est une antenne VHF conçue pour être installée sur les bateaux à voile avec le fouet en fibre de verre qui, grâce à une peinture polyuréthane de couleur blanche, assurant une protection totale aux composants en cuivre situés à l'intérieur de l'antenne. Elles sont toutes équipées du connecteur spécial Glomex "RA106 solderless" étanche et sans soudure pour en faciliter l'installation.

Accessoires inclus:

- ▶ câble coaxial 18m RG58ALL.
- ▶ Connecteur PL259 male nichelé (code RA132).
- ▶ Protection pour connecteur (code RA138).
- ▶ Pass-fil en nylon (code RA140).
- ▶ Support en acier inoxydable electro-poli pour installation sur tête de mât (code RA106BRACKINOX).

Le antenne della serie RA106 sono affidabili e robuste, ideali per tutti i tipi d'imbarcazione a vela, a motore e per i gommoni (versioni RIB). RA106GRPSB18 è un'antenna VHF destinata alle barche a vela, con stilo in fibra di vetro che dispone di una verniciatura poliuretana di colore bianco che assicura la protezione totale dei componenti di rame interni. È dotata dello speciale connettore stagno Glomex "RA106 solderless", impermeabile e senza saldatura, che ne facilita l'installazione.

Prodotti inclusi con l'antenna:

- ▶ cavo coassiale da 18m RG58ALL.
- ▶ Connettore PL259 maschio nichelato (codice RA132).
- ▶ Protezione in gomma per connettore (codice RA138).
- ▶ Passacavo in nylon (codice RA140).
- ▶ Staffa in acciaio inox elettrolucidato aisi 316 per installazione in testa d'albero (codice RA106BRACKINOX).

SUPPLIED ACCESSORIES



▲ RG58ALL 18m (59') coax cable



▲ RA132 PL259 male nickel-plated connector



▲ RA138 pvc rubber protection for connector



▲ RA140 nylon feed-thru



▲ RA106BRACKINOX stainless steel masthead bracket

OPTIONAL ACCESSORIES



▲ RA201 VHF/AM-FM/AIS splitter

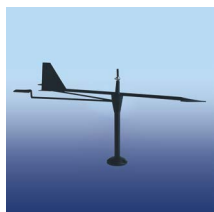

▲ RA179 wind indicator



RA106SLSSB25

900mm (35") VHF antenna for sail boat with stainless steel whip, 25m (82') coax cable and masthead bracket

Category: VHF

Subcategories: Aloud series

Code: RA106SLSSB25



🇬🇧 The RA106 series antennas are reliable and solid, ideal for any type of boat, whether a sailboat or a motorboat and for tenders as well (version RIB). RA106SLSSB25 is a VHF antenna designed for sailboats with the tapered stainless steel rod which can absorb extreme forces without damage. It's equipped with Glomex "RA106 solderless" special connector, waterproof and solderless, easing the installation.

Supplied accessories:

- ▶ coaxial cable - 25m/82' RG58ALL
- ▶ PL259 male nichel-plated connector (code RA132)
- ▶ RA132) pvc rubber protection for connector (code RA138)
- ▶ nylon feed-thru (code RA140)
- ▶ electropolished stainless steel masthead bracket (code RA106BRACKINOX)

FREQUENCY RANGE	156/162 MHz
GAIN AVERAGE	3dB
IMPEDANCE	50 ohms
POLARIZATION	Vertical
SWR	≤ 1,3 at 156,8 MHz
MAX IMPUT POWER	100 W
DC GROUND	yes
LENGHT	900mm/35"
TERMINATION	RA106 solderless connector
<i>More info on www.glomex.it</i>	

Les antennes de la série RA106 sont fiables et solides, idéales pour tout type de bateau, à voile et à moteur, mais aussi pour des « Zodiacs » et autres bateaux pneumatiques (version RIB). RA106SLSSB25 est une antenne VHF conçue pour être installée sur les bateaux à voile, avec le fouet conique en acier inoxydable qui peut absorber les fluctuations sans subir de dommages. Elles sont toutes équipées du connecteur spécial Glomex "RA106 solderless" étanche et sans soudure pour en faciliter l'installation.

Accessoires inclus:

- ▶ câble coaxial 25m RG58ALL.
- ▶ Connecteur PL259 male nichelé (code RA132)
- ▶ protection pour connecteur (code RA138)
- ▶ pass-fil en nylon (code RA140)
- ▶ support en acier inoxydable electro-poli pour installation sur tete de mat (code RA106BRACKINOX)

Le antenne della serie RA106 sono affidabili e robuste, ideali per tutti i tipi d'imbarcazione a vela, a motore e per i gommoni (versioni RIB). RA106SLSSB25 è un'antenna VHF destinata all'installazione su barche a vela con lo stilo in acciaio inox conificato Aisi 316 che può assorbire qualsiasi fluttuazione senza subire danni. È dotata dello speciale connettore stagno Glomex "RA106 solderless", impermeabile e senza saldatura, che ne facilita l'installazione.

Prodotti inclusi con l'antenna:

- ▶ cavo coassiale da 25m RG58ALL.
- ▶ Connettore PL259 maschio nichelato (codice RA132).
- ▶ Protezione in gomma per connettore (codice RA138).
- ▶ Passacavo in nylon (codice RA140).
- ▶ Staffa in acciaio inox elettrolucidato per installazione in testa d'albero (codice RA106BRACKINOX).

SUPPLIED ACCESSORIES



▲ RG58ALL 25m (82')
coax cable



▲ RA132 PL259 male
nichel-plated connector



▲ RA138 pvc rubber
protection for connector



▲ RA140 nylon feed-thru



▲ RA106BRACKINOX
stainless steel masthead
bracket

OPTIONAL ACCESSORIES



▲ RA201 VHF/AM-FM/AIS
splitter



▲ RA179 wind indicator



RA106GRPSB25

900mm (35") VHF antenna for sail boat with glossy fibre-glass whip, 25m (82') coax cable and masthead bracket

Category: VHF

Subcategories: Aloud series

Code: RA106GRPSB25



🇬🇧 The RA106 series antennas are reliable and solid, ideal for any type of boat, whether a sailboat or a motorboat and for tenders as well (version RIB). RA106GRPSB25 is a VHF antenna designed for sailboats with a fibre-glass rod which takes advantage of white polyurethane paint, assuring a total protection of the antennas' inside copper components. It's equipped with Glomex "RA106 solderless" special connector, waterproof and solderless, easing the installation.

Supplied accessories:

- ▶ coaxial cable - 25m/82' RG58ALL.
- ▶ PL259 male nichel-plated connector (code ra132).
- ▶ Pvc rubber protection for connector (code RA138).
- ▶ Nylon feed-thru (code RA140).
- ▶ Electropolished stainless steel masthead bracket (code RA106BRACKINOX).

FREQUENCY RANGE	156/162 MHz
GAIN AVERAGE	3dB
IMPEDANCE	50 ohms
POLARIZATION	Vertical
SWR	≤ 1,3 at 156,8 MHz
MAX IMPUT POWER	100 W
DC GROUND	yes
LENGHT	900mm/35"
TERMINATION	RA106 solderless connector
<i>More info on www.glomex.it</i>	

Les antennes de la série RA106 sont fiables et solides, idéales pour tout type de bateau, à voile et à moteur, mais aussi pour des « Zodiacs » et autres bateaux pneumatiques (version RIB). RA106GRPSB25 est une antenne VHF conçue pour être installée sur les bateaux à voile avec le fouet en fibre de verre qui, grâce à une peinture polyuréthane de couleur blanche, assurant une protection totale aux composants en cuivre situés à l'intérieur de l'antenne. Elles sont toutes équipées du connecteur spécial Glomex "RA106 solderless" étanche et sans soudure pour en faciliter l'installation.

Accessoires inclus:

- ▶ câble coaxial 25m RG58ALL
- ▶ Connecteur PL259 male nichelé (code RA132)
- ▶ protection pour connecteur (code RA138)
- ▶ pass-fil en nylon (code RA140)
- ▶ support en acier inoxydable electro-poli pour installation sur tête de mât (code RA106BRACKINOX)

Le antenne della serie RA106 sono affidabili e robuste, ideali per tutti i tipi d'imbarcazione a vela, a motore e per i gommoni (versioni RIB). RA106GRPSB25 è un'antenna VHF destinata alle barche a vela, con stilo in fibra di vetro che dispone di una verniciatura poliuretana di colore bianco che assicura la protezione totale dei componenti di rame interni. È dotata dello speciale connettore stagno Glomex "RA106 solderless", impermeabile e senza saldatura, che ne facilita l'installazione.

Prodotti inclusi con l'antenna:

- ▶ cavo coassiale da 25m RG58ALL.
- ▶ Connettore PL259 maschio nichelato (codice RA132).
- ▶ Protezione in gomma per connettore (codice RA138).
- ▶ Passacavo in nylon (codice RA140).
- ▶ Staffa in acciaio inox elettrolucidato per installazione in testa d'albero (codice RA106BRACKINOX).

SUPPLIED ACCESSORIES



▲ RG58ALL 25m (82') coax cable



▲ RA132 PL259 male nickel-plated connector



▲ RA138 pvc rubber protection for connector



▲ RA140 nylon feed-thru



▲ RA106BRACKINOX stainless steel masthead bracket

OPTIONAL ACCESSORIES



▲ RA201 VHF/AM-FM/AIS splitter

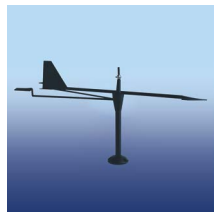

▲ RA179 wind indicator

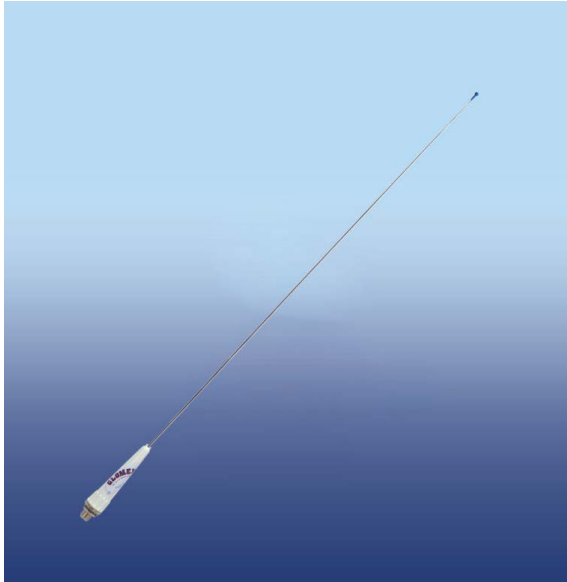

RA109SLS

900mm (35") VHF antenna with stainless steel whip and masthead bracket

Category: VHF

Subcategories: Aloud series

Code: RA109SLS



🇬🇧 The RA109 series antennas are expressly designed for installation on sailboats, and they stand out for their optimum performance. RA109SLS a VHF antenna compact in size, just 900 mm/35", in stainless steel rod.

Supplied accessories:

- ▶ PL259 male nichel-plated connector (code RA132)
- ▶ pvc rubber protection for connector (code RA138)
- ▶ nylon feed-thru (code RA140)
- ▶ electropolished stainless steel masthead bracket (code RA106BRACKINOX)

FREQUENCY RANGE	156/162 MHz
GAIN AVERAGE	3dB
IMPEDANCE	50 ohms
POLARIZATION	Vertical
SWR	≤ 1,3 at 156,8 MHz
MAX IMPUT POWER	100 W
DC GROUND	yes
LENGHT	900mm/35"
WEIGHT	180g/6,35oz
TERMINATION	SO239 for PL259 male connector
<i>More info on www.glomex.it</i>	

Les antennes de la série RA109 sont spécialement conçues pour être installées sur les voiliers, et se caractérisent par leurs performances optimales. RA109SLS est une antenne VHF de dimensions compactes, elle mesure seulement 900 mm/35", avec un fouet en acier inoxydable.

Accessoires inclus:

- ▶ connecteur PL259 male nichelé (code RA132).
- ▶ Protection pour connecteur (code RA138).
- ▶ Pass-fil en nylon (code RA140).
- ▶ Support en acier inoxydable electro-poli pour installation sur tête de mât (code RA106BRACKINOX).

Le antenne della serie RA109 sono appositamente studiate per l'installazione su barche a vela, e si contraddistinguono per le ottime performance. RA109SLS è un'antenna VHF compatta, alta appena 900 mm, con lo stilo in acciaio inox.

Prodotti inclusi con l'antenna:

- ▶ connettore PL259 maschio nichelato (codice RA132).
- ▶ Protezione in gomma per connettore (codice RA138).
- ▶ Passacavo in nylon (codice RA140).
- ▶ Staffa in acciaio inox elettrolucidato per installazione in testa d'albero (codice RA106BRACKINOX).

SUPPLIED ACCESSORIES



▲ RA132 PL259 male nickel-plated connector



▲ RA138 pvc rubber protection for connector



▲ RA140 nylon feed-thru



▲ RA106BRACKINOX stainless steel masthead bracket

OPTIONAL ACCESSORIES



▲ RA152/10 10m (33') coax cable



▲ RA152/20 20m (66') coax cable



RA109GRP

900mm (35") VHF antenna with glossy fibreglass whip and masthead bracket

Category: VHF

Subcategories: Aloud series

Code: RA109GRP



🇬🇧 The RA109 series antennas are expressly designed for installation on sailboats, and they stand out for their optimum performance. RA109GRP is a VHF antenna compact in size, just 900 mm/35", in fibreglass rod.

Supplied accessories:

- ▶ PL259 male nichel-plated connector (code RA132)
- ▶ pvc rubber protection for connector (code RA138)
- ▶ nylon feed-thru (code RA140)
- ▶ electropolished stainless steel masthead bracket (code RA106BRACKINOX)

FREQUENCY RANGE	156/162 MHz
GAIN AVERAGE	3dB
IMPEDANCE	50 ohms
POLARIZATION	Vertical
SWR	≤ 1,3 at 156,8 MHz
MAX IMPUT POWER	100 W
DC GROUND	yes
LENGHT	900mm/35"
WEIGHT	180g/6,35oz
TERMINATION	SO239 for PL259 male connector
<i>More info on www.glomex.it</i>	

Les antennes de la série RA109 sont spécialement conçues pour être installées sur les voiliers, et se caractérisent par leurs performances optimales. RA109GRP est une antenne VHF de dimensions compactes, elle mesure seulement 900 mm/35", avec un fouet en fibre de verre.

Accessoires inclus:

- ▶ connecteur PL259 male nichelé (code RA132)
- ▶ protection pour connecteur (code RA138)
- ▶ pass-fil en nylon (code RA140).
- ▶ Support en acier inoxydable electro-poli pour installation sur tête de mât (code RA106BRACKINOX)

Le antenne della serie RA109 sono appositamente studiate per l'installazione su barche a vela, e si contraddistinguono per le ottime performance. RA109GRP è un'antenna VHF compatta, alta appena 900 mm/35", con lo stilo in fibra di vetro.

Prodotti inclusi con l'antenna:

- ▶ connettore PL259 maschio nichelato (codice RA132).
- ▶ Protezione in gomma per connettore (codice RA138).
- ▶ Passacavo in nylon (codice RA140).
- ▶ Staffa in acciaio inox elettrolucidato per installazione in testa d'albero (codice RA106BRACKINOX).

SUPPLIED ACCESSORIES



▲ RA132 PL259 male nichel-plated connector



▲ RA138 pvc rubber protection for connector



▲ RA140 nylon feed-thru



▲ RA106BRACKINOX stainless steel masthead bracket

OPTIONAL ACCESSORIES



▲ RA152/10 10m (33') coax cable



▲ RA152/20 20m (66') coax cable



RA104SSAUS

1m (3') VHF antenna with self-supporting stainless steel mount

Category: VHF

Subcategories: Classic series

Code: RA104SSAUS



RA104SSAUS is the VHF Glomex antenna with a 2 way stainless steel integrated mount and plug-n-play! It's a solid antenna, thanks to a tube of double-layer fibreglass and protected by 5 layers of polyurethane paint it is resistant to UV-rays, and it's the perfect solution for the small mid sizes motor boat.

The internal $\frac{1}{2}$ wave antenna element assures the best communication possible, due to the resulting extended angle of transmission on the horizontal plane. For this reason RA104SSAUS, as well as having a premium look, is one of the most performing VHF antennas on the market

RA104SSAUS est l'antenne Glomex VHF, déjà complète à la base avec une rotule en acier inoxydable à 2 voies et prête à être installée! Elle est un antenne solide, grâce à son support à double-épaisseur en fibre de verre, protégé par 5 couches de vernis polyuréthane résistant aux rayons UV, et est la solution parfaite pour les petites et moyennes embarcations à moteur.

L'élément interne de l'antenne $\frac{1}{2}$ onde assure la meilleure communication possible sur un large angle d'irradiation sur le plan horizontal. Pour tous ces motifs, la RA104SSAUS outre à posséder un super look, c'est la meilleure antenne VHF existante sur le marché.

FREQUENCY RANGE	156/162 MHz
GAIN AVERAGE	3dB
IMPEDANCE	50 ohms
POLARIZATION	Vertical
SWR	$\leq 1,3$ at 156,8 MHz
MAX IMPUT POWER	100 W
DC GROUND	yes
LENGHT	1m/3"
WEIGHT	180g/6,35oz
TERMINATION	Cable
<i>More info on www.glomex.it</i>	

RA104SSAUS è l'antenna VHF Glomex completa di base a snodo in acciaio inox, pronta per essere installata! È un'antenna robusta, grazie al tubo in fibra di vetro a doppio spessore protetto con 5 strati di vernice poliuretana resistente ai raggi UV, ed è ideale per le piccole e medie imbarcazioni a motore.

L'elemento a $\frac{1}{2}$ onda interno dell'antenna assicura la migliore comunicazione possibile con un esteso lobo di irradiazione sul piano orizzontale. Per questo RA104SSAUS, oltre a possedere un look premium, è una delle antenne VHF più robuste e performanti esistenti sul mercato.

SUPPLIED ACCESSORIES



▲ RA132 PL259 male nickel-plated connector



▲ RG58ALL 4,5m (5') coax cable

RA104NYAUS

1m (3') VHF antenna with self-supporting nylon mount

Category: VHF

Subcategories: Classic series

Code: RA104NYAUS



🇺🇸 RA104NYAUS is the VHF Glomex antenna with a 2 way nylon integrated mount and plug-n-play! It's a solid antenna, thanks to a tube of double-layer fibreglass and protected by 5 layers of polyurethane paint it is resistant to UV-rays, and it's the perfect solution for the small mid sizes motor boat.

The internal $\frac{1}{2}$ wave antenna element assures the best communication possible, due to the resulting extended angle of transmission on the horizontal plane. For this reason RA104NYAUS, as well as having a premium look, is one of the most performing VHF antennas on the market.

🇮🇹 RA104NYAUS est l'antenne Glomex VHF, déjà complète à la base avec une rotule en nylon à 2 voies et prête à être installée! Elle est un antenne solide, grâce à son support à double-épaisseur en fibre de verre, protégé par 5 couches de vernis polyuréthane résistant aux rayons UV, et est la solution parfaite pour les petites et moyennes embarcations à moteur.

L'élément interne de l'antenne $\frac{1}{2}$ onde assure la meilleure communication possible sur un large angle d'irradiation sur le plan horizontal. Pour tous ces motifs, la RA104NYAUS outre à posséder un super look, c'est la meilleure antenne VHF existante sur le marché.

FREQUENCY RANGE	156/162 MHz
GAIN AVERAGE	3dB
IMPEDANCE	50 ohms
POLARIZATION	Vertical
SWR	$\leq 1,3$ at 156,8 MHz
MAX IMPUT POWER	100 W
DC GROUND	yes
LENGHT	1m/3"
WEIGHT	180g/6,35oz
TERMINATION	Cable

More info on www.glomex.it

🇮🇹 RA104NYAUS è l'antenna VHF Glomex completa di base a snodo in nylon, pronta per essere installata! È un'antenna robusta, grazie al tubo in fibra di vetro a doppio spessore protetto con 5 strati di vernice poliuretana resistente ai raggi UV, ed è ideale per le piccole e medie imbarcazioni a motore.

L'elemento a $\frac{1}{2}$ onda interno dell'antenna assicura la migliore comunicazione possibile con un esteso lobo di irradiazione sul piano orizzontale. Per questo RA104NYAUS, oltre a possedere un look premium, è una delle antenne VHF più robuste e performanti esistenti sul mercato.

SUPPLIED ACCESSORIES



▲ RA132 PL259 male nickel-plated connector



▲ RG58ALL 4,5m (5') coax cable

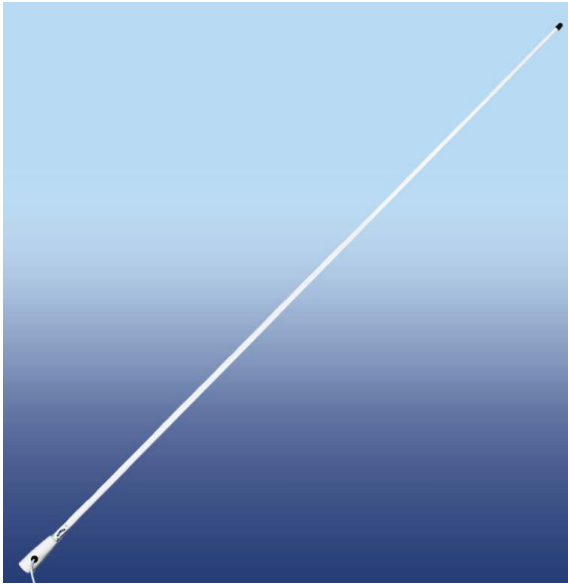

RA112

1,5m (5') VHF antenna with nylon ferrule and 4,5m (15') coax cable

Category: VHF

Subcategories: Classic series

Code: RA112



🇬🇧 The CLASSIC series antennas are designed to fit the specific needs of all motorboats. RA112 is the ideal choice for excellent performance and reduced size, just 1,5 m (5') height. It's a VHF antenna equipped with white nylon ferrule and polyurethane tube resistant to UV-rays.

Supplied accessories:

- ▶ coaxial cable - 4,5m/15' RG58ALL
- ▶ PL259 male nichel-plated connector (code RA132)

🇮🇹 Les antennes de la série CLASSIC sont spécialement conçues pour les bateaux à moteur. RA112 représentent le choix idéal pour qui recherche des résultats excellents et des dimensions réduites, une hauteur de seulement 1,5 m (5'). Elle est une antenne VHF avec embase de nylon blanc et tube en polyuréthane résistant aux rayons UV.

Accessoires inclus:

- ▶ câble coaxial 4,5m RG58ALL.
- ▶ Connecteur PL259 male nichelé (code RA132)

FREQUENCY RANGE	156/162 MHz
GAIN AVERAGE	3dB
IMPEDANCE	50 ohms
POLARIZATION	Vertical
SWR	≤ 1,3 at 156,8 MHz
MAX IMPUT POWER	100 W
DC GROUND	yes
LENGHT	1,5m/5"
WEIGHT	450g/15,90oz
TERMINATION	Cable
<i>More info on www.glomex.it</i>	

🇮🇹 Le antenne della serie CLASSIC sono state progettate per rispondere alle specifiche esigenze delle barche a motore. RA112 è la scelta ideale per chi ricerca risultati eccellenti e dimensioni compatte, appena 1,5 m (5') di altezza. È un'antenna VHF dotata di boccola in nylon bianco e tubo in poliuretano resistente agli UV.

Prodotti inclusi con l'antenna:

- ▶ cavo coassiale da 4,5m RG58ALL.
- ▶ Connettore PL259 maschio nichelato (codice RA132).

SUPPLIED ACCESSORIES



▲ RG58ALL 4,5m (15') coax cable



▲ RA132 PL259 male nichel-plated connector

OPTIONAL ACCESSORIES



▲ RA135 nylon 4 way ratchet mount

RA112CR

1,5m (5') VHF antenna with chromed brass ferrule and 4,5m (15') coax cable

Category: VHF

Subcategories: Classic series

Code: RA112CR



🇮🇹 The CLASSIC series antennas are designed to fit the specific needs of all motorboats. RA112CR is the ideal choice for excellent performance and reduced size, just 1,5 m (5') height. It's a VHF antenna equipped with chromed bushing and polyurethane tube resistant to UV-rays.

Supplied accessories:

- ▶ coaxial cable - 4,5m/15' RG58ALL
- ▶ PL259 male nichel-plated connector (code RA132)

🇮🇹 Les antennes de la série CLASSIC sont spécialement conçues pour les bateaux à moteur. RA112CR représentent le choix idéal pour qui recherche des résultats excellents et des dimensions réduites, une hauteur de seulement 1,5 m (5'). Elle est une antenne VHF avec embase chromée et tube en polyuréthane résistant aux rayons UV.

Accessoires inclus:

- ▶ câble coaxial 4,5m RG58ALL.
- ▶ Connecteur PL259 male nichelé (code RA132)



FREQUENCY RANGE	156/162 MHz
GAIN AVERAGE	3dB
IMPEDANCE	50 ohms
POLARIZATION	Vertical
SWR	≤ 1,3 at 156,8 MHz
MAX IMPUT POWER	100 W
DC GROUND	yes
LENGHT	1,5m/5"
WEIGHT	580g/20,45oz
TERMINATION	Cable

More info on www.glomex.it

🇮🇹 Le antenne della serie CLASSIC sono state progettate per rispondere alle specifiche esigenze delle barche a motore. RA112CR è la scelta ideale per chi ricerca risultati eccellenti e dimensioni compatte, appena 1,5 m (5') di altezza. È un'antenna VHF dotata di boccola cromata e tubo in poliuretano resistente agli UV.

Prodotti inclusi con l'antenna:

- ▶ cavo coassiale da 4,5m RG58ALL.
- ▶ Connettore PL259 maschio nichelato (codice RA132).

SUPPLIED ACCESSORIES



▲ RG58ALL 4,5m (15') coax cable



▲ RA132 PL259 male nichel-plated connector

OPTIONAL ACCESSORIES



▲ RA107SSFME stainless steel mount

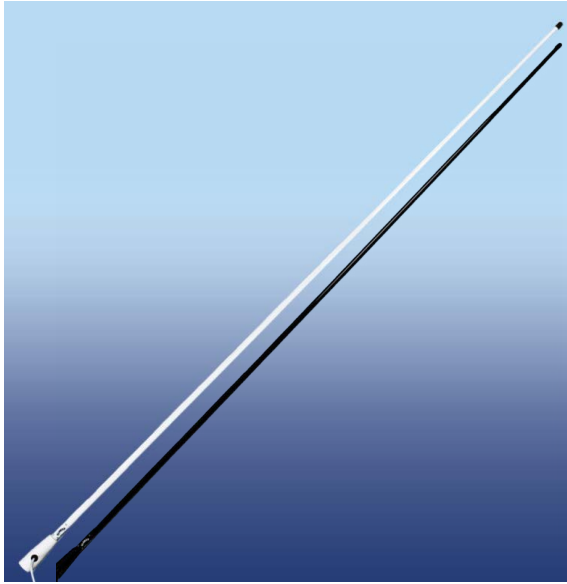

RA400

1,5m (5') VHF antenna with nylon ferrule and 4,5m (15') coax cable

Category: VHF

Subcategories: Basic line

Code: RA400, RA400/BK



RA400 is the new VHF antenna of the "BASIC LINE" series which guarantees exceptional quality that distinguishes Glomex but at a very smart price. With compact dimensions (just 1.5m/5'), anti UV nylon ferrule and an average gain of 3dB, this marine antenna is the ideal choice for those looking for excellent results and compact size for their motor boat.

Supplied accessories:

- ▶ Coaxial cable - 4,5m/15' RG58ALL
- ▶ PL259 male connector not included

La RA400 est la nouvelle antenne VHF de la série "BASIC LINE" qui garantit la qualité exceptionnelle de Glomex mais à un prix très abordable. Avec des dimensions compactes (seulement 1,5 m), embase en nylon anti-UV et un gain moyen de 3 dB, cette antenne marine est la choix idéale pour ceux qui recherchent d'excellents résultats et une taille compacte pour leur bateau à moteur.

Accessoires inclus:

- ▶ Câble coaxial 4,5m RG58ALL.
- ▶ Connecteur PL259 male ne pas inclus

FREQUENCY RANGE	156/162 MHz
GAIN AVERAGE	3dB
IMPEDANCE	50 ohms
POLARIZATION	Vertical
SWR	≤ 1,3 at 156,8 MHz
MAX IMPUT POWER	100 W
DC GROUND	yes
LENGHT	1,5m/5"
WEIGHT	450g/15,90oz
TERMINATION	Cable
<i>More info on www.glomex.it</i>	

La RA400 è la nuova antenna VHF della serie "BASIC LINE" che vi garantisce la qualità eccezionale che distingue Glomex ma ad un prezzo molto conveniente. Con dimensioni compatte (appena 1,5m), boccola in nylon anti U.V. ed un guadagno medio di 3dB, questa antenna marina la scelta ideale per chi ricerca risultati eccellenti e dimensioni compatte per la propria barca a motore.

Prodotti inclusi con l'antenna:

- ▶ cavo coassiale da 4,5m RG58ALL.
- ▶ Connettore PL259 maschio non incluso

SUPPLIED ACCESSORIES



▲ RG58ALL 4,5m (15') coax cable



▲ RA132GOLD PL259 male gold-plated connector



▲ RA132 PL259 male nickel-plated connector



▲ RA135 nylon 4 way ratchet mount

OPTIONAL ACCESSORIES

RA1206NY

2,4m (8') VHF antenna with nylon ferrule and 4,5m (15') coax cable

Category: VHF

Subcategories: Classic series

Code: RA1206NY

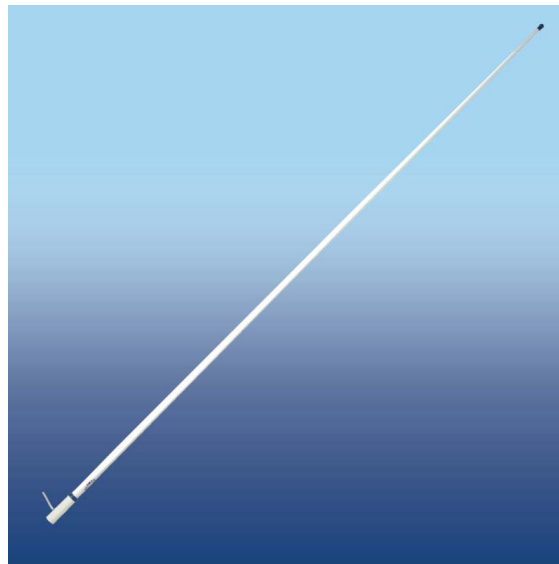

🇬🇧 The CLASSIC series antennas are designed to fit the specific needs of all motorboats. RA1206NY is an economical and light VHF antenna, containing solid brass components inside. It's equipped with nylon bushing and double-layer painted tube with polished polyurethane resistant to UV-rays.

Supplied accessories:

- ▶ coaxial cable - 4,5m/15' RG58ALL
- ▶ pl259 male nichel-plated connector (code ra132)

FREQUENCY RANGE	156/162 MHz
GAIN AVERAGE	6dB
IMPEDANCE	50 ohms
POLARIZATION	Vertical
SWR	≤ 1,3 at 156,8 MHz
MAX IMPUT POWER	100 W
DC GROUND	yes
LENGHT	2.4m/8"
WEIGHT	456g/16,08oz
TERMINATION	Cable

More info on www.glomex.it

🇫🇷 Les antennes de la série CLASSIC sont spécialement conçues pour les bateaux à moteur. RA1206NY est une antenne VHF économique et légère, qui contenant à l'intérieur de solides composants en laiton. Elle est dotée d'une embase en nylon et d'un fouet à double-épaisseur laqué en polyuréthane brillant résistant aux rayons UV.

Accessoires inclus:

- ▶ câble coaxial 4,5m RG58ALL.
- ▶ Connecteur PL259 male nichelé (code RA132)

🇮🇹 Le antenne della serie CLASSIC sono state progettate per rispondere alle specifiche esigenze delle barche a motore. RA1206NY è un'antenna VHF economica e leggera che presenta solidi elementi d'ottone al suo interno. È dotata di boccola in nylon bianco e tubo a doppio spessore laccato in poliuretano lucido resistente ai raggi U.V.

Prodotti inclusi con l'antenna:

- ▶ cavo coassiale da 4,5m RG58ALL.
- ▶ Connettore PL259 maschio nichelato (codice RA132).

SUPPLIED ACCESSORIES



▲ RG58ALL 4,5m (15') coax cable



▲ RA132 PL259 male nichel-plated connector

OPTIONAL ACCESSORIES



▲ RA135 nylon 4 way ratchet mount



▲ RA115 nylon 4 way ratchet mount

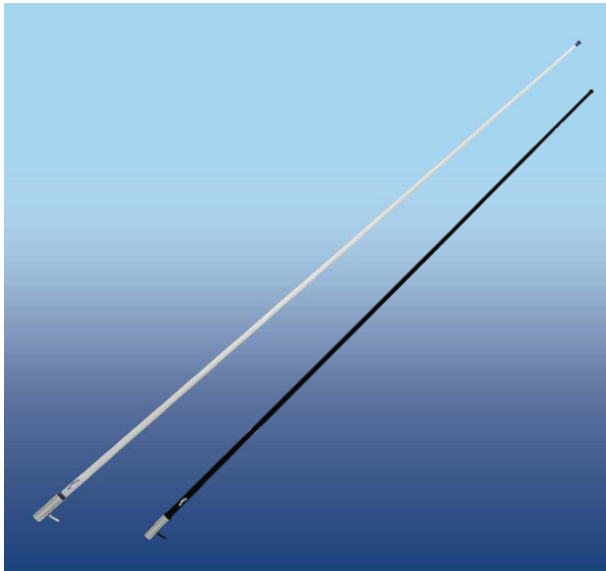

RA1206CR

2,4m (8') VHF antenna with chromed brass ferrule and 4,5m (15') coax cable

Category: VHF

Subcategories: Classic series

Code: RA1206CR, RA1206CR/BK



🇬🇧 The CLASSIC series antennas are designed to fit the specific needs of all motorboats. RA-1206CR is an economical and light VHF antenna, containing solid brass components inside. It's equipped with chromed bushing and double-layer painted tube with polished polyurethane resistant to UV-rays.

Supplied accessories:

- ▶ coaxial cable - 4,5m/15' RG58ALL
- ▶ PL259 male nichel-plated connector (code RA132)

🇮🇹 Les antennes de la série CLASSIC sont spécialement conçues pour les bateaux à moteur. RA1206CR est une antenne VHF économique et légère, qui contenant à l'intérieur de solides composants en laiton. Elle est dotée d'une embase chromée et d'un fouet à double-épaisseur laqué en polyuréthane brillant résistant aux rayons UV.

Accessoires inclus:

- ▶ Câble coaxial 4,5m RG58ALL
- ▶ Connecteur PL259 male nichelé (code RA132)

FREQUENCY RANGE	156/162 MHz
GAIN AVERAGE	6dB
IMPEDANCE	50 ohms
POLARIZATION	Vertical
SWR	≤ 1,3 at 156,8 MHz
MAX IMPUT POWER	100 W
DC GROUND	yes
LENGHT	2.4m/8"
WEIGHT	670g/23,63lb
TERMINATION	Cable
<i>More info on www.glomex.it</i>	

🇮🇹 Le antenne della serie CLASSIC sono state progettate per rispondere alle specifiche esigenze delle barche a motore. RA-1206CR è un'antenna VHF economica e leggera che presenta solidi elementi d'ottone al suo interno. È dotata di boccia cromata e tubo a doppio spessore laccato in poliuretano lucido resistente ai raggi U.V.

Prodotti inclusi con l'antenna:

- ▶ Cavo coassiale da 4,5m RG58ALL.
- ▶ Connettore PL259 maschio nichelato (codice RA132).

SUPPLIED ACCESSORIES



▲ RG58ALL 4,5m (15') coax cable



▲ RA132 PL259 male nichel-plated connector

OPTIONAL ACCESSORIES



▲ RA107SSFME stainless steel 4 way ratchet mount



▲ RA116SS stainless steel 4 way ratchet mount



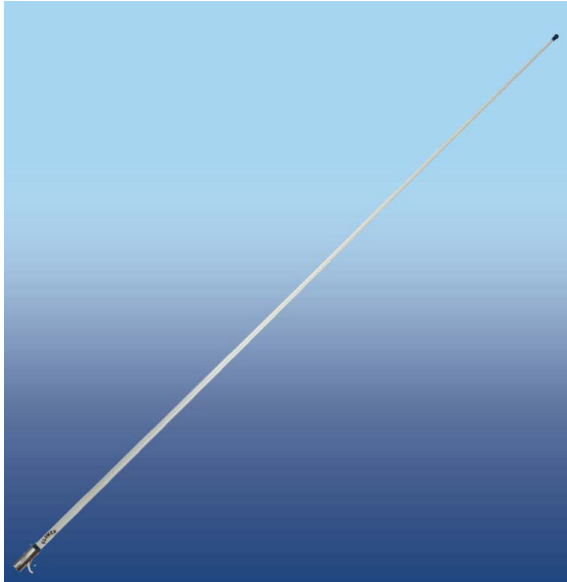

RA1225HP

2,4m (8') VHF high performance antenna with stainless steel ferrule, integrated stainless steel feed-thru, 7,6m (25') RG-8X coax cable with pre-wired FME connector and PL-259 adaptor

Category: VHF

Subcategories: High performance series

Code: RA1225HP



RA1225HP is a collinear antenna 2.40 m (8') in height, designed to assure excellent performance in terms of quality, operation and design. RA1225HP has the special integrated stainless steel feed-thru on the ferrule and is supplied with the PL-259 adaptor for an easy, fast and safe installation. Compared to the traditional antennas, whilst similar in shape, this antenna deeply differentiates itself due to the inside finish and the rod features. Made of spiral copper wires inserted in brass tubes, this antenna assures a long-range communication and best radio performance. The tube is made of fibreglass with polished polyurethane finish and resistant to UV-rays and is reinforced by a double layer (1,2 mm/0,05'.) RA1225HP is a vertical polarization antenna minimizing the effect of reflection on flat surfaces.

Supplied accessories:

- ▶ 7,6m/25' RG-8X coaxial cable with pre-wired FME connector
- ▶ FME/PL259 male nichel plated adaptor/connector (code RA352)

FREQUENCY RANGE	156/162 MHz
GAIN AVERAGE	3dB
IMPEDANCE	50 ohms
POLARIZATION	Vertical
SWR	≤ 1,3 at 156,8 MHz
MAX IMPUT POWER	100 W
DC GROUND	yes
LENGHT	2.4m/8"
WEIGHT	742g/26,17oz
TERMINATION	Cable
<i>More info on www.glomex.it</i>	



RA1225HP est une antenne colinéaire de 2,40 m (8') de haut, conçue pour garantir d'excellentes performances en termes de qualité, de fonctionnalité et de design. Le RA1225HP possède une pass-fil en acier inoxydable spécial et intégré sur la virole et est fourni avec l'adaptateur PL-259 pour une installation facile, rapide et sûre. Par rapport aux antennes traditionnelles, dont elle ne conserve que l'apparence, cette antenne se différencie par ses finitions intérieures et par les caractéristiques de son fouet. Fabriquée en fils de cuivre en spirale insérés dans des tubes en laiton, cette antenne assure une communication de longue portée et une très bonne réception radio. Le tube en fibres de verre avec finition en polyuréthane brillant résistant aux rayons UV, est renforcé par un tube à double épaisseur (1,2 mm/0,05') qui en renforce la structure. RA1225HP est une antenne à polarisation verticale qui minimise les effets de réflexion sur des surfaces planes.

Accessoires inclus:

- ▶ câble coaxial 7,6m RG-8X avec connecteur FME pre-installé
- ▶ Connecteur/adaptateur FME/PL259 male sans soudure.

RA1225HP è un'antenna collineare alta 2.40 m (8'), progettata per garantire performances eccellenti in termini di qualità, funzionalità e design. RA1225HP ha lo speciale passacavo in acciaio inossidabile integrato nella boccola ed è fornita con l'adattatore PL-259 per un'installazione facile, veloce e sicura. Rispetto alle antenne tradizionali, delle quali mantiene solo l'apparenza, si differenzia profondamente per le finiture interne e le caratteristiche dello stilo. Costruita con fili di rame spiralato inseriti in tubi d'ottone, assicura una comunicazione a lungo raggio e prestazioni ottimali delle radio. Il tubo, realizzato in fibra di vetro con finiture in poliuretano lucido resistente ai raggi U.V., presenta un tubo a doppio spessore (1,2 mm/0,05') che ne rinforza la struttura. RA1225HP è un'antenna a polarizzazione verticale che minimizza gli effetti di riflessione sulle superfici piane.

Prodotti inclusi con l'antenna:

- ▶ cavo coassiale da 7,6m RG-8X a bassa perdita con connettore FME per-cablato.
- ▶ Connettore/adattatore PL259/FME senza saldature

SUPPLIED ACCESSORIES



▲ RG-8X 7,6m (25') pre-wired coax cable

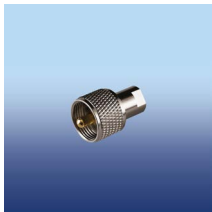

▲ RA352 FME/PL259 male nickel-plated adaptor/connector

OPTIONAL ACCESSORIES



▲ RA116SS stainless steel 4 way ratchet mount



RA121

VHF antenna - same size of Avior (code VT300) DVB-T2 TV antenna

Category: VHF

Subcategories: Match Appearance

Code: RA121



RA121 is a VHF antennas identical to the VT300 Avior omnidirectional TV antenna, allowing you to keep a balanced look of your boat. It's a compact VHF antenna (diameter 100 mm/4", height 210 mm/8") conceived for any vessel, whether sailboat or motorboat, and it's provided with all necessary accessories for installation.

Supplied accessories:

- ▶ coaxial cable - 9m/30' RG58ALL
- ▶ PL259 male nichel-plated connector (code RA132)
- ▶ nylon mount

RA121 est une antenne VHF de forme et de dimension identiques à l'antenne TV omnidirectionnelle V9114 Vega, pour conserver un aspect équilibré à votre bateau. Elle est une antenne VHF compacte (diamètre 100 mm/4", hauteur 210 mm/8") conçue pour tout type de bateau, aussi bien à voile qu'à moteur, et est équipée avec tous les accessoires nécessaires pour l'installation.

Accessoires inclus:

- ▶ câble coaxial 9m RG58ALL.
- ▶ Connecteur PL259 male nichelé (code RA132).
- ▶ Base en nylon

RA121 è un'antenna VHF identica per forma e dimensione all'antenna TV omnidirezionale V9114 Vega, che consente di mantenere un look bilanciato sulla propria imbarcazione. È un'antenna VHF compatta (diametro 100 mm/4", altezza 210 mm/8") destinata a tutti i tipi d'imbarcazione a vela e a motore, ed è fornita di tutti gli accessori necessari per l'installazione.

Prodotti inclusi con l'antenna:

- ▶ cavo coassiale da 9m rg58all.
- ▶ Connettore pl259 maschio nichelato (codice ra132).
- ▶ Base in nylon.

FREQUENCY RANGE	156/162 MHz
GAIN AVERAGE	1dB
IMPEDANCE	50 ohms
POLARIZATION	Vertical
SWR	≤ 1,3 at 156,8 MHz
MAX IMPUT POWER	50 W
DC GROUND	yes
LENGHT	210m/8"
WEIGHT	250g/8,81oz
TERMINATION	SO239 for PL259 male connector
<i>More info on www.glomex.it</i>	

SUPPLIED ACCESSORIES



▲ RG58ALL 9m (30') coax cable



▲ RA132 PL259 male nichel plated connector



▲ Nylon mount

OPTIONAL ACCESSORIES



▲ V9123 stainless steel masthead bracket



▲ V9124 stainless steel ratchet mount

RA124

VHF antenna - same size of Altair (code V9126AGC)
DVB-T2 TV antenna and weBBoat 4G Plus EVO (code IT1004PLUSEVO) coastal internet system

Category: VHF

Subcategories: Match Appearance

Code: RA124



RA124 is a VHF antennas identical to the V9126 Altair omnidirectional TV antenna, allowing you to keep a balanced look of your boat. It's a compact VHF antenna (diameter 250 mm/10", height 300 mm/12"), designed for motorboats, and it's provided with all necessary accessories for installation.

Supplied accessories:

- ▶ coaxial cable - 9m/30' RG58ALL PL259
- ▶ male nichel-plated connector (code RA132)
- ▶ nylon mount

RA124 est une antenne VHF de forme et de dimension identiques à l'antenne TV omnidirectionnelle V9126 Altair, pour conserver un aspect équilibré à votre bateau. Elle est une antenne VHF compacte (diamètre 250 mm/10", hauteur 300 mm/12") conçue pour les bateaux à moteur, et est équipée avec tous les accessoires nécessaires pour l'installation.

Accessoires inclus:

- ▶ câble coaxial 9m RG58ALL.
- ▶ Connecteur PL259 male nichelé (code RA132)
- ▶ base en nylon



FREQUENCY RANGE	156/162 MHz
GAIN AVERAGE	1dB
IMPEDANCE	50 ohms
POLARIZATION	Vertical
SWR	≤ 1,3 at 156,8 MHz
MAX IMPUT POWER	50 W
DC GROUND	no
LENGHT	300mm/12"
WEIGHT	430g/15,17oz
TERMINATION	SO239 for PL259 male connector
<i>More info on www.glomex.it</i>	

RA124 è un'antenna VHF identica per forma e dimensione all'antenna TV omnidirezionale V9126 Altair, che consente di mantenere un look bilanciato sulla propria imbarcazione. È un'antenna VHF compatta (diametro 250 mm/10", altezza 300 mm/12") destinata alle imbarcazioni a motore, ed è fornita di tutti gli accessori necessari per l'installazione.

Prodotti inclusi con l'antenna:

- ▶ cavo coassiale da 9m RG58ALL.
- ▶ Connettore PL259 maschio nichelato (codice RA132).
- ▶ Base in nylon.

SUPPLIED ACCESSORIES



▲ RG58ALL 9m (30') coax cable



▲ RA132 PL259 male nichel plated connector



▲ Nylon mount

OPTIONAL ACCESSORIES



▲ V9123 stainless steel masthead bracket



▲ V9124 stainless steel ratchet mount



RA111

140mm (5") masthead VHF antenna with 18m (59') coax cable

Category: VHF

Subcategories: Regatta & Emergency

Code: RA111



🇬🇧 The REGATTA & EMERGENCY series antennas are characterized by compactness and functionality. RA111 is a small VHF antenna (140mm/5"), protected by a tapered synthetic rubber tube that can be installed, on the sailboats or motorboats. It is equipped with 18m (59') of coaxial cable and with a PL259 male connector.

Supplied accessories:

- ▶ coaxial cable - 18m/59' RG58ALL PL259
- ▶ male nichel-plated connector (code RA132)

🇫🇷 Les antennes de la série Glomex REGATTA & EMERGENCY sont caractérisés par la compacité et la fonctionnalité. RA111 est une petite antenne VHF (140 mm/5"), protégée par un tube conique en caoutchouc synthétique, qui peut être installée sans distinction sur des bateaux à voiles ou à moteur. Elle est dotée d'un câble coaxial de 18 m (59') et d'un connecteur mâle PL259.

Accessoires inclus:

- ▶ câble coaxial 18m RG58ALL.
- ▶ Connecteur PL259 male nichelé (code RA132)

🇮🇹 Le antenna della serie Glomex REGATTA & EMERGENCY si caratterizzano per compattezza e funzionalità. RA111 è una piccola antenna VHF (140mm/5") protetta da un tubo conico di gomma sintetica che può essere installata, indistintamente, sulle barche a vela e a motore. È dotata di 18 m (59') di cavo coassiale e connettore maschio PL259.

Prodotti inclusi con l'antenna:

- ▶ cavo coassiale da 18m RG58ALL.
- ▶ Connettore PL259 maschio nichelato (codice RA132).

FREQUENCY RANGE	156/162 MHz
GAIN AVERAGE	1dB
IMPEDANCE	50 ohms
POLARIZATION	Vertical
SWR	≤ 1,3 at 156,8 MHz
MAX IMPUT POWER	50 W
DC GROUND	no
LENGHT	140mm/5"
WEIGHT	220g/7,76oz
TERMINATION	SO239 for PL259 male connector
<i>More info on www.glomex.it</i>	

SUPPLIED ACCESSORIES



▲ RG58ALL 18m (59') coax cable



▲ RA132 PL259 male nichel plated connector





RA114

350mm (14") Emergency antenna with 9m (30') coax cable and quick installation kit

Category: VHF

Subcategories: Regatta & Emergency

Code: RA114



🇬🇧 The REGATTA & EMERGENCY series antennas are characterized by compactness and functionality. RA114 is an emergency antenna, to be used in case the main antenna is broken or temporarily idle. This small antenna, only 350mm (14") high, is equipped with 9m (30') of coaxial cable and PL259 male connector.

Supplied accessories:

- ▶ 9m/30' RG58ALL coax cable
- ▶ PL259 male nickel-plated connector (code RA132)
- ▶ Quick installation kit

🇫🇷 Les antennes de la série Glomex REGATTA & EMERGENCY sont caractérisés par la compacité et la fonctionnalité. RA114 est une antenne de secours, à utiliser en cas de casse ou dysfonctionnement temporaire de l'antenne principale. Cette petite antenne, d'à peine 350 mm de haut, est dotée de 9 m (30') de câble coaxial et d'un connecteur mâle PL259.

Accessoires inclus:

- ▶ Câble coaxial RG58ALL 9m
- ▶ Connecteur PL259 mâle nickelé (code RA132)
- ▶ Kit d'installation

🇮🇹 Le antenna della serie Glomex REGATTA & EMERGENCY si caratterizzano per compattezza e funzionalità. RA114 è un'antenna d'emergenza da utilizzare in caso di rottura o temporanea inattività dell'antenna principale. Questa piccola antenna, alta appena 350 mm (14"), è dotata di 9 m (30') di cavo coassiale e connettore maschio PL259.

Prodotti inclusi con l'antenna:

- ▶ Cavo coassiale RG58ALL 9m
- ▶ Connettore PL259 maschio nichelato (codice RA132).
- ▶ Kit di installazione.

FREQUENCY RANGE	156/162 MHz
GAIN AVERAGE	1dB
IMPEDANCE	50 ohms
POLARIZATION	Vertical
SWR	≤ 1,3 at 156,8 MHz
MAX INPUT POWER	50 W
DC GROUND	no
LENGTH	140mm/5"
WEIGHT	220g/7,76oz
TERMINATION	SO239 for PL259 male connector
<i>More info on www.glomex.it</i>	

SUPPLIED ACCESSORIES



▲ 9m/30' RG58ALL coax cable



▲ PL259 male nickel-plated connector

RA201

VHF/AM-FM/AIS splitter

Category: AIS

Code: RA201



🇬🇧 The RA201 splitter allows to use just one VHF antenna to simultaneously receive the AM/FM and AIS radio signals; furthermore, the VHF transceiver can also be used. It is a compact, economical and safe element, easy to install in any place. It requires only a 12V power supply with maximum of just 25 mA power consumption. It is provided with a coaxial input for the antenna and three outputs for VHF, AM/FM radio and AIS. Thanks to an electronic circuit specifically developed by Glomex and the presence of a built-in preamplifier, the RA201 splitter is able to offer high performance in its three applications, ensuring effective transmission and reception for VHF. The splitter maximum power for VHF is 100 W, therefore twice as much as most devices on the market.

IMPEDANCE: 50 Ohm
RANGE OF RADIO RECEPTION: 100 KHz to 200 MHz (GO/PO/OC/FM included)
RANGE OF TRANSMISSION/RECEPTION VHF: 100 MHz to 200 MHz (marine/ham radio)
RANGE OF AIS RECEPTION: 100 MHz to 200 MHz
BUILT-IN PREAMPLIFIER: 15 dB shared on two inputs (to compensate power loss)
VHF POWER RANGE: from 0.2 watts min to 100 watts max
MAXIMUM CONSUMPTION: 25 mA
VOLTAGE SUPPLY: 13.8 V (from 10 V min. to 16 V max)
CABLE SUPPLY: length 60 cm (2 feet) red (+) and black (-)
PROTECTION: glass fuse 5x20 mm -315 mA (included)
VHF ANTENNA: SO239 jack
VHF: RG 58 C/U cable 60 cm (2 feet) long + male PL259 plug
RADIO: RG 59 A/U cable 60 cm (2 feet) long + male Motorola plug
AIS: RG 58 C/U cable 60 cm (2 feet) long + male BNC plug
CASING: length 83 mm (3" 1/4) x width 48 mm (2") x height 38 mm (3" 1/4)
ANTI-SPREADING METAL-EPOXY PAINT, HIGH RESISTANCE TO RUST AND OXIDIZATION
FIXING: by 4 M4 crews
<i>More info on www.glomex.it</i>

🇫🇷 Le répartiteur RA201 permet de utiliser une seule antenne pour recevoir les signaux VHF simultanément radio AM/FM et AIS, en plus de VHF. Il est un appareil compact, économique, sécuritaire et facile à installer partout qui nécessite 12 V avec un maximum de consommation de seulement 25 mA. Le répartiteur RA201 a une entrée coaxiale pour l'antenne et trois sorties dédiées à l'émetteur VHF, radio AM/FM et l'AIS. Grâce au circuit électronique développé spécifiquement par Glomex, et à la présence d'un amplificateur incorporé, RA201 est capable d'assurer haute performance dans les trois applications de son utilisation prévue, sans perte de qualité du signal. La puissance maximale prise en charge par le séparateur VHF est de 100 W, donc, le double de la puissance délivrée par la majorité des dispositifs sur le marché.

🇮🇹 Lo splitter RA201 permette di utilizzare un'unica antenna VHF per ricevere simultaneamente i segnali radio AM/FM e AIS, oltre a quelli VHF. Si tratta di un elemento compatto, economico, sicuro e facile da installare ovunque. Richiede un'alimentazione a 12 V con un assorbimento massimo di appena 25 mA. Lo splitter RA201 è dotato di un ingresso coassiale per l'antenna e di tre uscite dedicate al trasmettitore VHF, alla radio AM/FM e al ricevitore AIS. Grazie al circuito elettronico appositamente sviluppato da Glomex e alla presenza di un pre-amplificatore interno, RA201 è in grado di garantire prestazioni elevate nei tre impieghi cui è destinato, senza perdita di qualità del segnale. La potenza massima supportata dallo splitter per il VHF è di 100 W, dunque, il doppio della potenza erogata dalla maggior parte degli apparati in commercio.



RA111AIS

140mm (5") masthead AIS antenna with 9m (30') coax cable

Category: AIS

Code: RA111AIS



The Automatic Identification System (AIS) is a monitoring system of naval traffic, useful for navigation safety with difficult meteorological conditions (fog or nocturnal navigation.) The AIS system operates on 2 expressly dedicated VHF channels (161.975 and 162.025 MHz) and allows the user to receive real time information about the traffic in the surrounding area. Glomex has planned and produced a range of calibrated antennas exactly for the specific VHF frequencies and for the AIS standards. The RA111AIS antenna is protected by a tapered synthetic rubber tube and can be installed, on either sailboats or motorboats. Thanks to the V9181 support supplied, the RA111AIS can be installed in a vertical or horizontal position, on the mast or on the pulpit.

Supplied accessories:

- ▶ coaxial cable - 9m/30' RG58ALL with BNC male connector
- ▶ BNC female / TNC male adaptor (code RA155)
- ▶ PVC rubber protection for connector (code RA138)
- ▶ Mounting bracket in stainless steel electro-polished, for horizontal and vertical mount on tube diameter 7/8" (22mm) to 1"1/4 (30mm) (code: V9181)

FREQUENCY RANGE	161,975 – 162,025 MHz
GAIN AVERAGE	1dB
IMPEDANCE	50 ohms
POLARIZATION	Vertical
SWR	≤ 1,2 at 162 MHz
MAX IMPUT POWER	50 W
DC GROUND	no
LENGHT	140mm/5"
WEIGHT	220g/7,76oz
TERMINATION	SO239 for PL259 male connector
<i>More info on www.glomex.it</i>	

🇫🇷 L'Automatic Identification System (AIS) est un système de surveillance du trafic naval, utile pour la sécurité de la navigation dans des conditions météorologiques difficiles (brouillard ou navigation nocturne). Le système AIS fonctionne sur 2 canaux VHF dédiés (161.975 et 162.025 MHz) et permet de recevoir des informations sur le trafic alentour en temps réel. Glomex a conçu et réalisé une gamme d'antennes calibrées exactement pour les fréquences spécifiques de VHF et pour les normes AIS. L'antenne RA111AIS est protégée par un tube conique en caoutchouc synthétique et peut être installée aussi bien sur les bateaux à voiles que sur les bateaux à moteur. Grâce au support V9181 fourni, la RA111AIS peut être installée en position verticale ou horizontale, sur le mât ou sur le pont.

Accessoires inclus:

- ▶ Câble coaxial 9m RG58ALL avec connecteur BNC male.
- ▶ Adaptateur BNC female / TNC male (code RA155)
- ▶ Protection pour connecteur (code RA138)
- ▶ Rotule en acier inoxydable poli pour fixation horizontale ou verticale sur balcon de diamètre de 22 à 30 mm (code V9181)

🇮🇹 L'Automatic Identification System (AIS) è un sistema di monitoraggio del traffico navale, utile per la sicurezza della navigazione in condizioni meteorologiche difficili (nebbia o navigazione notturna). Il sistema AIS funziona su 2 canali VHF appositamente dedicati (il 161,975 Mhz e il 162,025 Mhz) e consente di ricevere informazioni in tempo reale sul traffico nell'area circostante. Glomex ha progettato e realizzato una gamma di antenne calibrate esattamente per le frequenze VHF specifiche per gli standard AIS. L'antenna RA111AIS è protetta da un tubo conico di gomma sintetica e può essere installata, indistintamente, sulle barche a vela e a motore. Grazie alla fornitura del supporto V9181, infatti, La RA111AIS può essere installata in posizione verticale od orizzontale, sull'albero o sul pulpito.

Prodotti inclusi con l'antenna:

- ▶ Cavo coassiale da 9m RG58ALL con connettore BNC maschio. Adattatore BNC femmina / TNC maschio (codice: RA155).
- ▶ Protezione in gomma per connettore (codice RA138).
- ▶ Staffa di supporto in acciaio inox elettrolucidato aisi 316 per installazione su tubo verticale o orizzontale con diametro da 22 a 30 mm (code: V9181).

OPTIONAL ACCESSORIES



▲ 9m/30' RG58ALL coax cable



▲ BNC female / TNC male adaptor



▲ Electropolished mounting bracket



▲ PVC protection

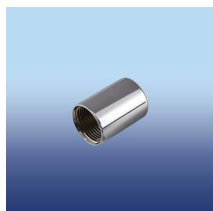

▲ RA106ADAPT1X14 1"x14 adaptor



RA110AIS

1m (3') AIS antenna

Category: AIS

Code: RA110AIS



The Automatic Identification System (AIS) is a monitoring system of naval traffic, useful for navigation safety with difficult meteorological conditions (fog or nocturnal navigation.) The AIS system operates on 2 expressly dedicated VHF channels (161.975 and 162.025 MHz) and allows the user to receive real time information about the traffic in the surrounding area. Glomex has planned and produced a range of calibrated antennas exactly for the specific VHF frequencies and for the AIS standards. The RA110AIS will receive signals on AIS frequencies very efficiently even when the antenna, because of the boat rolling and pitching, is not perfectly vertical. The polished polyurethane paint and the waterproof connector will allow this antenna to maintain an excellent performance for many years.

Supplied accessories:

- ▶ stainless steel adaptor standard 1"x14 thread (code RA106ADAPT1X14)

FREQUENCY RANGE	161,975 – 162,025 MHz
GAIN AVERAGE	3dB
IMPEDANCE	50 ohms
POLARIZATION	Vertical
SWR	≤ 1,2 at 162 MHz
MAX IMPUT POWER	50 W
DC GROUND	no
LENGHT	1m/3"
WEIGHT	536g/18,90oz
TERMINATION	SO239 for PL259 male connector
<i>More info on www.glomex.it</i>	

🇮🇹 L'Automatic Identification System (AIS) est un système de surveillance du trafic naval, utile pour la sécurité de la navigation dans des conditions météorologiques difficiles (brouillard ou navigation nocturne). Le système AIS fonctionne sur 2 canaux VHF dédiés (161.975 et 162.025 MHz) et permet de recevoir des informations sur le trafic alentour en temps réel. Glomex a conçu et réalisé une gamme d'antennes calibrées exactement pour les fréquences spécifiques de VHF et pour les normes AIS. La RA110AIS permet une réception efficace des signaux sur les fréquences AIS, même lorsque l'antenne, n'est pas parfaitement verticale à cause du roulis et du tangage du bateau. Le vernis en polyuréthane brillant et le connecteur étanche permettent à l'antenne de garder des performances élevées dans le temps.

Accessoires inclus:

- ▶ adaptateur en acier inoxydable electro-poli - filetage standard 1"x14 (CODE RA106ADAPT1X14).

🇮🇹 L'Automatic Identification System (AIS) è un sistema di monitoraggio del traffico navale, utile per la sicurezza della navigazione in condizioni meteorologiche difficili (nebbia o navigazione notturna). Il sistema AIS funziona su 2 canali VHF appositamente dedicati (il 161,975 Mhz e il 162,025 Mhz) e consente di ricevere informazioni in tempo reale sul traffico nell'area circostante. Glomex ha progettato e realizzato una gamma di antenne calibrate esattamente per le frequenze VHF specifiche per gli standard AIS. La RA110AIS consente di ricevere efficacemente il segnale sulle frequenze AIS anche quando l'antenna, a causa dei movimenti di rollio e beccheggio dell'imbarcazione, non è perfettamente in posizione verticale. La verniciatura in poliuretano lucido e il connettore stagno consentono all'antenna di mantenere prestazioni elevate nel tempo.

Prodotti inclusi con l'antenna:

- ▶ adattatore in acciaio inox elettrolucidato aisi 316, filettatura standard 1"x14 (codice RA106ADAPT1X14).

OPTIONAL ACCESSORIES



▲ RA152/10 10m (33')
RG58ALL low loss twin
screnn coax cable



▲ RA152/20 20m (66')
RG58ALL low loss twin
screnn coax cable

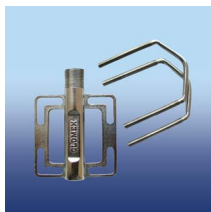

▲ V9171 electropolished
stainless steel pipe
mounting bracket

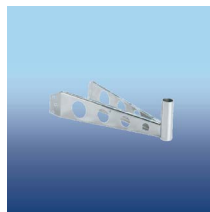

▲ V9173 electropolished
stainless steel masthead
bracket

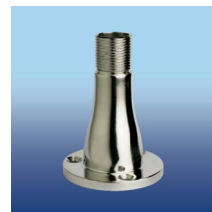

▲ V9174 electropolished
stainless steel mount



▲ V9176 electropolished
stainless steel masthead
L bracket



RA1281

300mm (12") AM/FM antenna with self-supporting mount

Category: AM/FM

Code: RA1281



🇬🇧 The AM/FM is a common VHF transmission mode. AM/FM bands are less prone to disturbances and interferences assuring a clear transmission and reception of signals. AM/FM antennas are often used to listen to radio stations also during navigation. RA1281 is a very solid AM-FM antenna, made of UV resistant synthetic rubber, and is 300mm (12") high.

Supplied accessories:

- ▶ coaxial cable - 3m/10' RG62

🇫🇷 Le mode de transmission AM-FM est utilisée pour la VHF. Les bandes AM/FM ne sont pas gênées par les perturbations et les interférences, assurant une transmission et une réception claires des signaux. Les antennes AM/FM sont souvent employées pour écouter les stations radio même pendant la navigation. La RA1281 est une antenne AM-FM très solide en caoutchouc synthétique incassable et qui ne jaunit pas, mesurant 300 mm (12") de haut.

Accessoires Inclus:

- ▶ Câble Coaxial 3m RG62.

FREQUENCY RANGE	161,975 – 162,025 MHz
GAIN AVERAGE	3dB
IMPEDANCE	50 ohms
POLARIZATION	Vertical
SWR	≤ 1,2 at 162 MHz
MAX IMPUT POWER	50 W
DC GROUND	no
LENGHT	1m/3"
WEIGHT	536g/18,90oz
TERMINATION	SO239 for PL259 male connector
<i>More info on www.glomex.it</i>	

🇮🇹 Quella in AM/FM è una modalità di trasmissione diffusa nel VHF. Le bande AM/FM infatti sono piuttosto immuni a disturbi e interferenze, garantendo una trasmissione e una ricezione chiara dei segnali. Le antenne AM/FM sono spesso utilizzate per ascoltare le stazioni radiofoniche anche in navigazione. RA1281 è un'antenna AM-FM molto solida, costruita in gomma sintetica anti-ingiallimento e antirottura, alta appena 300 mm (12").

Prodotti Inclusi Con L'antenna:

- ▶ Cavo Coassiale da 3m RG62.

SUPPLIED ACCESSORIES



▲ 3m (10') RG62 twin screen low loss coax cable

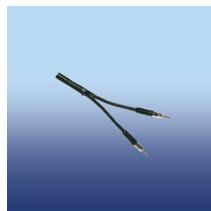

▲ V9149 2 way radio cable



▲ CE1262 3,6m (12") AM/FM radio extension cable



▲ CE1261/10 10m (33') AM/FM radio extension cable

OPTIONAL ACCESSORIES

RA128

1,5m (5') AM/FM antenan with nylon ferrule and 6m (20') coax cable

Category: AM/FM

Code: RA128



🇬🇧 The AM/FM is a common VHF transmission mode. AM/FM bands are less prone to disturbances and interferences assuring a clear transmission and reception of signals. AM/FM antennas are often used to listen to radio stations also during navigation. The RA128 is a 1,5 m (5') AM/FM antenna aimed for installation on motorboats and small yachts. Its shape is identical to that of the RA112 (VHF) and RA127 (CB) antennas for a balanced look of your boat.

Supplied accessories:

- ▶ coaxial cable - 6m/20' RG62

🇫🇷 Le mode de transmission AM-FM est utilisée pour la VHF. Les bandes AM/FM ne sont pas gênées par les perturbations et les interférences, assurant une transmission et une réception claires des signaux. Les antennes AM/FM sont souvent employées pour écouter les stations radio même pendant la navigation. La RA128 est une antenne AM-FM d'une hauteur de 1,5 m (5'), destinée à être installée sur des bateaux à moteur et sur de petits yachts. Sa forme est identique à celle des antennes RA112 (VHF) et RA127 (CB) pour conserver un aspect équilibré à votre bateau.

Accessoires inclus:

- ▶ câble coaxial 6m RG62

SUPPLIED ACCESSORIES



▲ 6m (20') RG62 twin screen low loss coax cable

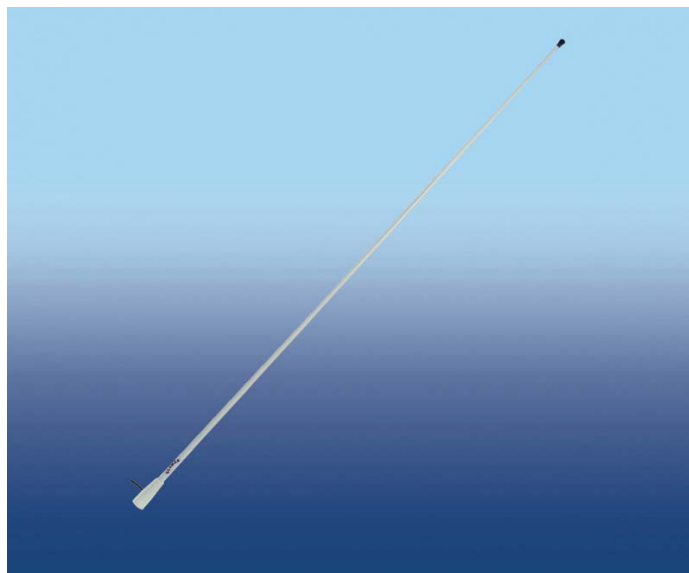

FREQUENCY RANGE	AM 550-1600 KHz - FM 88-108 MHz
IMPEDANCE	93 ohms
LENGHT	1,5m/5"
WEIGHT	490g/17,28oz
TERMINATION	Motorola plug

More info on www.glomex.it

🇮🇹 Quella in AM/FM è una modalità di trasmissione diffusa nel VHF. Le bande AM/FM infatti sono piuttosto immuni a disturbi e interferenze, garantendo una trasmissione e una ricezione chiara dei segnali. Le antenne AM/FM sono spesso utilizzate per ascoltare le stazioni radiofoniche anche in navigazione. RA128 è un'antenna AM-FM alta 1,5 m (5') destinata all'installazione su barche a motore e piccoli yacht. È identica per aspetto alle antenne RA112 (VHF) e RA127 (CB), per un look bilanciato sull'imbarcazione.

Prodotti inclusi con l'antenna:

- ▶ cavo coassiale da 6m RG62.

OPTIONAL ACCESSORIES



▲ RA135 nylon 4 way ratched mount

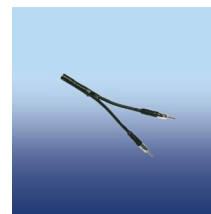

▲ V9149 2 way radio cable



▲ CE1262 3,6m (12") AM/FM radio extension cable



▲ CE1261/10 10m (33') AM/FM radio extension cable



RA127

1,5m (5') C.B. antenna with nylon ferrule and 4,5m (15') coax cable

Category: C.B.

Code: RA127



🇮🇹 The Citizens' Band, or CB, is a radio frequency band aimed for private communications. Ra127 is a cb antenna which assures a reliable and qualified communication system. Its shape is identical to that of the ra112 (vhf) and ra128 (am/fm) antennas for a balanced look of your boat.

Supplied accessories:

- ▶ Coaxial cable - 4,5m/15' RG58ALL
- ▶ PL-259 male nickel-plated connector (code RA132)

🇮🇹 L'antenne Citizens' Band, ou CB, est une bande de radiofréquence destinée à des communications privées. RA127 est une antenne CB qui assure un système de communication fiable et de qualité. Sa forme est identique à celle des antennes RA112 (VHF) et RA128 (AM/FM) pour conserver un aspect équilibré à votre bateau.

Accessoires inclus:

- ▶ Câble coaxial 4,5m RG58ALL.
- ▶ Connecteur PL-259 male nichelé (code RA132)

FREQUENCY RANGE	27 MHz
POLARIZATION	Vertical
IMPEDANCE	50 ohms on channel 20
SWR	≤ 1,2
MAX INPUT POWER	50 W
GAIN AVERAGE	Unity
DC GROUND	Yes
ANTENNA LENGHT	1,5m/5"
ANTENNA WEIGHT	1450g/15,90oz
TERMINATION	Cable
<i>More info on www.glomex.it</i>	

🇮🇹 La Citizens' Band, o CB, è una banda di frequenze radio destinata alle comunicazioni personali. RA127 è un'antenna CB che garantisce un sistema di comunicazione affidabile e di qualità. È identica per aspetto alle antenne RA112 (VHF) e RA128 (AM/FM), per un look bilanciato sull'imbarcazione.

Prodotti inclusi con l'antenna:

- ▶ Cavo coassiale da 4,5m RG58ALL.
- ▶ Connettore pl259 maschio nichelato (codice RA132).

SUPPLIED ACCESSORIES



▲ 4,5m (15') RG58C/U low loss twin screen coax cable



▲ PL259 male nickel-plated connector

OPTIONAL ACCESSORIES



▲ RA135 nylon 4 way ratched mount



▲ V9174 stainless steel mount

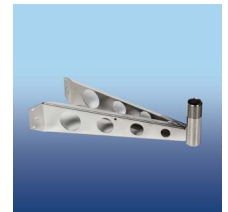

▲ V9173 electropolished stainless steel masthead bracket





RA135



4 way ratchet mount in reinforced nylon UV resistant design with knob, for deck or bulkhead.

Category: Mounts & accessories

Subcategories: Deck mounts

Code: RA135, RA135/BK



-  4 way ratchet mount in reinforced nylon UV resistant design with knob, for deck or bulkhead. Hole for GPS and feed-thru for coax cable. Usable with antennas no longer than 8' (2,4 m) in self supporting mode. Standard 1"x14 thread.
-  Support à double articulation en nylon traité anti-UV pour fixation sur pont ou cloison, avec blocage par molette. Passacâble pour câble coaxial. Pour antennes Glomeasy: RA106SLSFME, RA106GRPFME et RA300. Filetage 5/8"x24 .
-  Base a doppio snodo in nylon rinforzato resistente ai raggi UV con bloccaggio a manopola, per pulpito o ponte. CON SLOT CAVO E PASSACAVO. Utilizzabile con antenne non più lunghe di 2,4 m (8') autoportanti. Filettatura standard 1"x14.



RA115/BK



4 way ratchet black mount in reinforced nylon UV resistant design with handle locking, for deck or bulkhead. Hole for GPS and feed-thru for coax cable.

Category: Mounts & accessories

Subcategories: Deck mounts

Code: RA115, RA115/BK



-  4 way black ratchet mount in reinforced nylon UV resistant design with handle locking, for deck or bulkhead. Hole for GPS and feed-thru for coax cable. Usable with antennas no longer than 9' (2,7 m) in self supporting mode. Standard thread 1"x14.
-  Support noir à double articulation en nylon traité anti-UV pour fixation sur pont ou cloison, avec blocage par levier. Passacâble pour câble coaxial et GPS. Pour antennes de maximum 2,7 m (9') en fixations autoportantes. Filetage standard 1"x14.
-  Base nera a doppio snodo in nylon rinforzato resistente ai raggi UV, con bloccaggio a leva, per pulpito o ponte. Foro per cavo coassiale e passacavo per GPS. Utilizzabile con antenne autoportanti non più lunghe di 2,7 m (9'). Filettatura standard 1"x14.

V9175

Universal mount - reinforced nylon

Category: Mounts & accessories

Subcategories: Deck mounts

Code: V9175



🇬🇧 Universal mount reinforced nylon for GPS antennas only. Usable with RA129 extensions. Standard thread 1"x14, weight 2 oz (50 g), height 4" (100 mm).

🇫🇷 Support universel renforcé en nylon pour antennes GPS. Il peut être utilisé avec les rallonges RA129. Filetage standard 1"x14, poids 50 g (2 oz), hauteur 100 mm (4").

🇮🇹 Supporto universale in nylon rinforzato, adatto solo per antenne GPS. Utilizzabile con le prolunghe RA129. Filettatura standard 1"x14, peso 50 g (2 oz), altezza 100 mm (4").

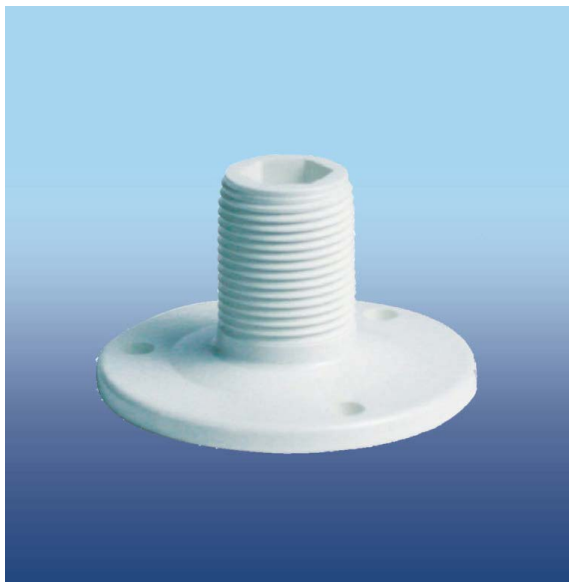

V9175OT



Universal mount - reinforced nylon

Category: Mounts & accessories

Subcategories: Deck mounts

Code: V9175OT



-  Universal mount reinforced nylon for GPS antennas only. Usable with RA129 extensions. Standard thread 1"x14, weight 1 oz (27 g), height 13/8" (40 mm).
-  Support universel renforcé en nylon pour antennes GPS. Il peut être utilisé avec les rallonges RA129. Filetage standard 1"x14, poids 27 g (1 oz), hauteur 40 mm (13/8").
-  Supporto universale in nylon rinforzato, adatto solo per antenne GPS. Utilizzabile con le prolunghe RA129. Filettatura standard 1"x14, peso 27 g (1 oz), altezza 40 mm (13/8").



RA116SS



Heavy duty 4 way ratched mout in stainless steel - handle locking - hole for cable - standard thread 1"x14.

Category: Mounts & accessories

Subcategories: Deck mounts

Code: RA116SS



-  Heavy duty 4 way ratchet mount polished stainless steel design with handle, for deck or bulkhead. Hole for GPS and feed-thru for coax cable. Standard 1"x14 thread.
-  Support double articulation en acier inoxydable poli, pour fixation sur pont ou cloison, avec blocage par levier. Passacâble pour câble coaxial et GPS. Filetage standard 1"x14.
-  Base a doppio snodo in acciaio inox elettrolucidato, con bloccaggio a leva, per pulpito o ponte. Foro per cavo GPS e passacavo per cavo coassiale. Filettatura standard 1"x14.

RA107SSFME

4 way ratched mout in stainless steel - locking by clamp - cable slot - standard thread 1"x14.

Category: Mounts & accessories

Subcategories: Deck mounts

Code: RA107SSFME



🇺🇸 4 way ratchet mount polished stainless steel design with clamp. Hole and feed-thru for coax cable. Standard 1"x14 thread. With special cable slot for a very easy passage of the cable without removal of most factory installed connectors

🇫🇷 Support double articulation en acier inoxydable poli, avec blocage à cliquet. Passacâble pour une installation très rapide. Filetage standard 1"x14.

🇮🇹 Base a doppio snodo in acciaio inox elettrolucidato Aisi 316, per una totale protezione dalla corrosione e dagli agenti atmosferici. Bloccaggio a levetta a scatto e PASSACAVO IMPERMEABILE. Dotata di slot laterale per cavo coassiale per il passaggio rapido senza la rimozione del connettore preinstallato. Filettatura standard 1"x14.

RA166/23

4 way ratched mout in stainless steel - handle locking - hole for cable - standard thread 1"x14.

Category: Mounts & accessories

Subcategories: Deck mounts

Code: RA166/23

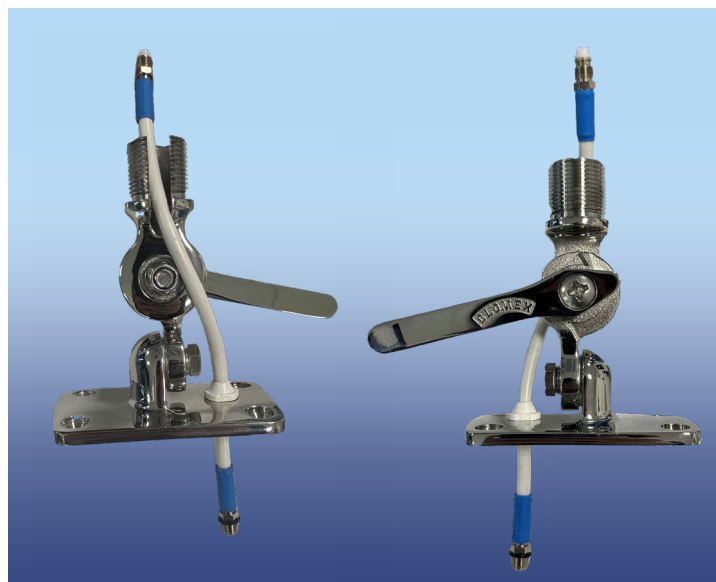

🇺🇸 4 way ratchet mount polished stainless steel design with handle locking, for deck or bulkhead. Hole for GPS and feed-thru for coax cable. Usable with antennas no longer than 9' (2,7 m) in self supporting mode. Standard 1"x14 thread.

🇫🇷 Support double articulation en acier inoxydable poli, pour fixation sur pont ou cloison, avec blocage à cliquet. Passacâble pour câble coaxial et GPS. Pour antennes de maximum 2,7m en fixations autoportantes. File-tage standard 1"x14.

🇮🇹 Base a doppio snodo in acciaio inox Aisi 316 elettrolucidato, con bloccaggio a leva, per pulpito o ponte. Foro per cavo GPS e passacavo per cavo coassiale. Utilizzabile con antenne non più lunghe di 2,7 m (9') autoportanti. Filettatura standard 1"x14.



RA176

4 way stainless steel free swivel mount - standard thread 1"x14 - must to be used with stand-off bracket.

Category: Mounts & accessories

Subcategories: Deck mounts

Code: RA176



🇬🇧 4 way stainless steel free swivel mount for any mounting location. Designed for a quick antenna lowering, it must be coupled with a stand-off bracket. Standard 1"x14 thread. Moreover, RA176 must be coupled with RA119 stand-off bracket (not included) for installing the following antennas: PRA702, PRA703 and PRA601.

🇫🇷 Support double articulation sans blocage en acier inoxydable, pour tous les emplacements de montage. Conçu pour une rapide descente de l'antenne, il doit être couplé avec un support intermédiaire. Filetage standard 1"x14. RA176 doit être utilisé avec le support intermédiaire RA119 (ne pas inclure) pour l'installation des antennes: PRA702, PRA703 et PRA601.

🇮🇹 Base libera a doppio snodo in acciaio inox, installabile in qualsiasi posizione. Progettata per un rapido e facile abbattimento dell'antenna, deve necessariamente essere abbinata ad uno stand-off bracket. Filettatura standard 1"x14.



V9177

Universal electropolished stainless steel mount for antennas and extensions - 40 mm (13/8") - standard thread 1"x14.

Category: Mounts & accessories

Subcategories: Deck mounts

Code: V9177



🇬🇧 Universal electropolished stainless steel mount for antennas and extensions - 40 mm (13/8") - standard thread 1"x14.

🇫🇷 V9177 est le support universel Glomex en acier inoxydable électro-poli pour antennes et rallonges - hauteur 40mm, filetage 1"x14

🇮🇹 V9177 è il nuovo supporto universale Glomex in acciaio inox elettrolucidato Aisi 316 per antenne e prolunghe.

V9174

Universal electropolished stainless steel mount for antennas and extensions - 100 mm (4") - standard thread 1"x14.

Category: Mounts & accessories

Subcategories: Deck mounts

Code: V9174



🇺🇸 Universal mount stainless steel for antennas and extensions. Standard thread 1"x14, weight 10 oz (280 g), height 4" (100 mm).

🇫🇷 Support universel renforcé en acier inoxydable poli pour antennes et rallonges. Filetage standard 1"x14, poids 280g, hauteur 100mm.

🇮🇹 Supporto universale in acciaio inox elettrolucidato, per antenne e prolunghe. Filettatura standard 1"x14, peso 280 g (5,3 oz), altezza 100 mm (13/8").



RA119

Stand-off bracket in reinforced nylon for SSB antennas and extensions

Category: Mounts & accessories

Subcategories: Deck mounts

Code: RA119



- Stand-off bracket reinforced nylon. For bulkhead and rail of Ø 1" (25 mm) and 1¼" (30 mm). It accepts Ø 1½" (38,5 mm) antennas and is supplied with plastic inserts for extensions diam. 1" (25 mm), 1 1/8" (28 mm) and 1¼" (30 mm).
- Support intermédiaire en nylon renforcé. Fixation sur cloison ou balcon (diam. 25mm ou 30mm). Pour antennes de diamètre de 38,5 mm et avec adaptateurs de diamètre de 25mm, 28 mm et 30mm.
- Staffa intermedia di fissaggio in nylon rinforzato per fissaggio su diametri di 25 mm (1"), 30 mm (1¼"). Adattabile anche ad antenne con diametro da 38,5 mm (1½") e fornita con accessori di diverso diametro per estensioni con diametro di 25 mm (1"), 28 mm (1 1/8") e 30 mm (1¼").



RA134

Rail swivel mount in reinforced nylon - horizontal and vertical rail - knob locking -hole for cable - standard thread 1"x14.

Category: Mounts & accessories

Subcategories: Rail mounts

Code: RA134



- Rail swivel mount in reinforced nylon UV resistant, design with knob locking and hole for GPS. Easy installation on vertical or horizontal rails of 7/8" (22mm) and 1" (25mm). Usable with antennas no longer than 8' (2,4 m) in self supporting mode. Standard 1"x14 thread.
- Rotule renforcée en nylon traité anti-UV, avec blocage par molette et passe-câble pour GPS. Fixation horizontale ou verticale sur balcon diamètre de 22mm a 25mm. Pour antennes de maximum 2,4 m (8') en fixations autoportantes. Filetage standard 1"x14.
- Base a snodo in nylon rinforzato resistente ai raggi UV con bloccaggio a manopola, CON SLOT CAVO. Installazione verticale od orizzontale su tubo di diametro compreso tra 22 mm (7/8") e 25 mm (1"). Utilizzabile con antenne non più lunghe di 2,4 m (8') autoportanti. Filettatura standard 1"x14.

RA125

Rail swivel mount in reinforced nylon - horizontal and vertical rail - handle locking - hole for cable - standard thread 1"x14.

Category: Mounts & accessories

Subcategories: Rail mounts

Code: RA125



🇺🇸 Rail swivel mount in reinforced nylon UV resistant, design with handle locking and hole for GPS. Easily installation on vertical or horizontal rails of 7/8" (22 mm) and 1" (25 mm). Usable with antennas no longer than 8' (2,4 m) in self supporting mode. Standard 1"x14 thread.

🇮🇹 Support orientable en nylon renforcée et traité anti-UV, avec blocage par levier et passe-câble pour GPS. Fixation horizontale ou verticale sur balcon diamètre de 22mm a 25mm. Pour antennes de maximum 2,4m en fixations autoportantes. Filetage standard 1"x14.

🇮🇹 Base a snodo in nylon rinforzato resistente ai raggi UV con bloccaggio a leva, CON SLOT CAVO. Installazione verticale od orizzontale su tubo di diametro compreso tra 22 mm (7/8") e 25 mm (1"). Utilizzabile con antenne non più lunghe di 2,4 m (8') autoportanti. Filettatura standard 1"x14.

RA145

Rail mount in reinforced nylon for gps antennas - horizontal rail - standard thread 1"x14.

Category: Mounts & accessories

Subcategories: Rail mounts

Code: RA145



🇺🇸 Rail mount in reinforced nylon UV resistant, for installation of GPS antennas on horizontal rails of 7/8" (22 mm) and 1" (25 mm). Usable with RA129 extension. Standard 1"x14 thread.

🇮🇹 Rotule renforcée en nylon traité anti-UV, pour installation d'antennes GPS sur balcon horizontale de diamètre de 22mm ou 25mm. Il peut être utilisé avec les rollonges RA129. Filetage standard 1"x14.

🇮🇹 Base in nylon rinforzato resistente ai raggi UV per l'installazione delle antenne GPS, su tubo orizzontale di diametro compreso tra 22 mm (7/8") e 25 mm (1"). Utilizzabile con prolunghie serie RA129. Filettatura standard 1"x14.



RA147EXT

Extension for antennas - 140 mm (5½") - white paint aluminium - 1"x14 standard thread.

Category: Mounts & accessories

Subcategories: Rail mounts

Code: RA147EXT



🇬🇧 RA147EXT is an aluminium extension for antennas, with glossy white paint and standard thread 1"X 14.

🇫🇷 RA147EXT est un rallonge pour antennes en aluminium laqué blanc, avec filetage standard 1"X 14.

🇮🇹 RA147EXT è una prolunga per antenne in alluminio laccato bianco e filettatura standard 1"X 14.



RA175

Adjustable rail mount in reinforced nylon and adaptors for rail diameters - horizontal rail

Category: Mounts & accessories

Subcategories: Rail mounts

Code: RA175



🇬🇧 Rail mount in reinforced nylon UV resistant, for installation of GPS antennas only on horizontal rails of 7/8" (22mm), 1" (25mm) and 1¼" (30 mm). Supplied with adaptors for all 3 rail diameters.

🇫🇷 Rotule renforcée en nylon traité anti-UV, pour installation d'antennes GPS sur balcon horizontale de diamètre de 22mm, 25mm ou 30mm. Fourni avec adaptateurs pour tous les 3 diamètres.

🇮🇹 Base in nylon rinforzato resistente ai raggi UV, per installazione solo su tubo orizzontale di diametro compreso tra 22 mm (7/8"), 25 mm (1") o 30 mm (1¼"), adattatori forniti.

RA147

Rail swivel mount in reinforced nylon with 100 mm (4") extension - horizontal and vertical rail - knob locking -hole for cable - standard thread 1"x14.

Category: Mounts & accessories

Subcategories: Rail mounts

Code: RA147



🇺🇸 Rail mount reinforced nylon UV resistant, design with knob locking, hole for GPS cable and extension 4" (100 mm). Easy installation on vertical or horizontal rails of 7/8" (22mm) and 1" (25mm). Usable with antennas no longer than 8' (2,4 m) in self-supporting mode. Standard thread 1"x14.

🇮🇹 Rotule renforcée en nylon traité anti-UV, avec blocage par molette, passe-câble pour GPS et rallonge de 100mm. Fixation horizontale ou verticale sur balcon diamètre de 22mm a 25mm. Pour antennes de maximum 2,4m en fixations autoportantes. Filetage standard 1"x14.

🇮🇹 Base a snodo in nylon rinforzato resistente ai raggi UV con bloccaggio a manopola, foro per cavo GPS e prolunga da 100 mm (4"). Installazione verticale od orizzontale su tubo di diametro compreso tra 22 mm (7/8") e 25 mm (1"). Utilizzabile con antenne non più lunghe di 2,4 m (8') autoportanti. Filettatura standard 1"x14.

RA165

Rail swivel mount in stainless steel - horizontal and vertical rail - handle locking - hole for cable - standard thread 1"x14.

Category: Mounts & accessories

Subcategories: Rail mounts

Code: RA165



🇺🇸 Rail ratchet mount stainless steel electropolished, design with handle locking and hole for GPS. Easily installation on vertical or horizontal rails of 7/8" (22mm) and 1" (25mm). Usable with antennas no longer than 8' (2,4 m) in self supporting mode. Standard thread 1"x14 .

🇮🇹 Rotule renforcée en acier inoxydable poli, avec blocage par levier et passe câble pour GPS. Fixation horizontale ou verticale sur balcon diamètre de 22mm a 25mm. Pour antennes de maximum 2,4 m (8') en fixations autoportantes. Filetage standard 1"x14.

🇮🇹 Base a snodo in acciaio inox elettrolucidato Aisi 316 con bloccaggio a leva e SLOT PER CAVO. Installazione verticale od orizzontale su tubo di diametro compreso tra 22 mm (7/8") e 25 mm (1"). Utilizzabile con antenne non più lunghe di 2,4 m (8') autoportanti. Filettatura standard 1"x14.

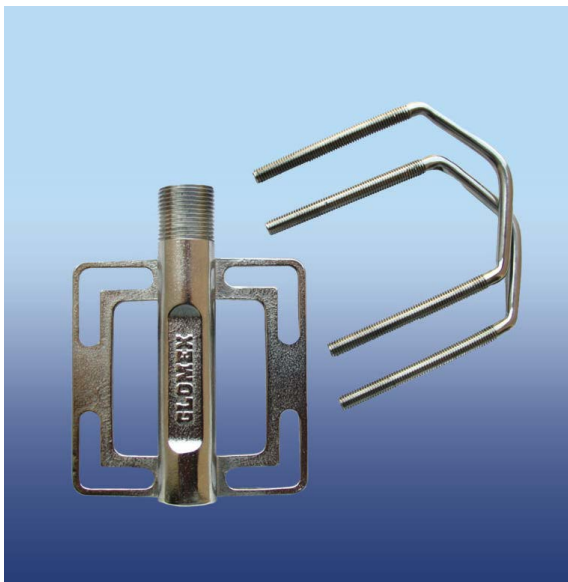

V9171

Stainless steel bracket - horizontal and vertical rail - standard thread 1"x14.

Category: Mounts & accessories

Subcategories: Rail mounts

Code: V9171



- 🇬🇧 Pipe mounting bracket in stainless steel. Mounts on vertical or horizontal rails diam. 7/8" (22 m) to 3" (80 m). Standard thread 1"x14, weight 21 oz (600 gr).
- 🇮🇹 Rotule en acier inox inoxydable pour fixation horizontale ou verticale sur balcon de diamètre de 22 à 80 mm. Filetage standard 1"x14, poids 600 grs.
- 🇮🇹 Staffa in acciaio inox elettrolucidato, per installazione su tubo orizzontale o verticale di diametro da 22 (7/8") a 80 mm (3"). Filettatura standard 1"x14, peso 600 gr.



RA106BRACKINOX-L

Stainless steel L masthead bracket

Category: Mounts & accessories

Subcategories: Masthead mounts and brackets

Code: RA106BRACKINOX-L



- 🇬🇧 Electropolished stainless steel L masthead bracket.
- 🇮🇹 Support en L en acier inoxydable électro-poli pour installation sur tête de mât
- 🇮🇹 Staffa in acciaio inox elettrolucidato Aisi 316 per installazione in testa d'albero.

V9181

Mounting bracket in stainless steel - horizontal and vertical rail - standard thread 1"x14.

Category: Mounts & accessories

Subcategories: Rail mounts

Code: V9181

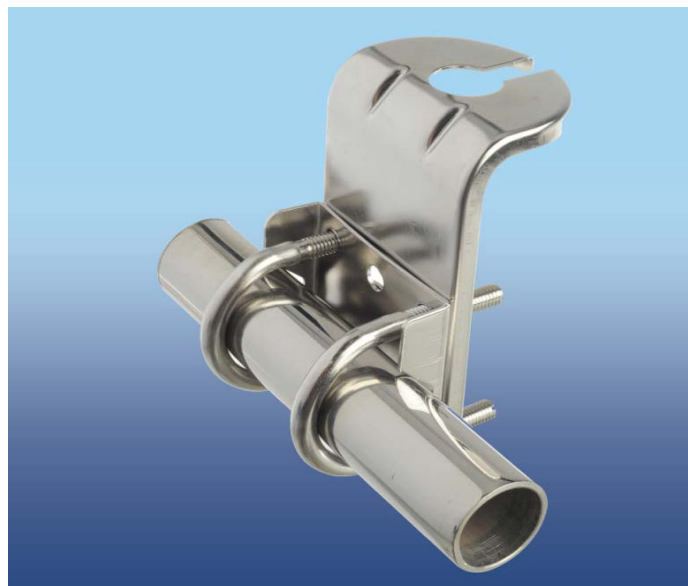

🇺🇸 Antenna mounting bracket in stainless steel electropolished. For horizontal and vertical mounting on rail diameter 7/8" (22 mm) to 1 1/4" (30 mm). Standard thread 1"x14.

🇮🇹 Rotule pour antenne en acier inoxydable poli. Pour fixation horizontale ou verticale sur balcon de diamètre de 22 à 30 mm. Filetage standard 1"x14.

🇮🇹 Staffa di supporto in acciaio inox elettrolucidato Aisi 316. Per installazione su tubo verticale o orizzontale con diametro da 22 mm (7/8") a 30 mm (1 1/4"). Filettatura standard 1"x14.

RA106BRACKINOX

Stainless steel masthead bracket

Category: Mounts & accessories

Subcategories: Masthead mounts and brackets

Code: RA106BRACKINOX



🇺🇸 Electropolished stainless steel masthead bracket.

🇮🇹 Support en acier inoxydable électro-poli pour installation sur tête de mât.

🇮🇹 Staffa in acciaio inox elettrolucidato AISI 316 per installazione in testa d'albero.



RA106BRACKET



Aluminium masthead bracket

Category: Mounts & accessories

Subcategories: Masthead mounts and brackets

Code: RA106BRACKET



-  Aluminium masthead bracket. White glossy polyester UV resistant painted.
-  Support en aluminium pour installation sur tête de mât. Peinture brillante en polyester blanc, résistant aux rayons UV.
-  Staffa in alluminio per installazione in testa d'albero. Verniciatura in poliestere UV resistente, colore bianco.



V9176

L masthead bracket in stainless steel - standard thread 1"x14

Category: Mounts & accessories

Subcategories: Masthead mounts and brackets

Code: V9176



-  L masthead bracket in stainless steel electropolished, standard thread 1"x14, height 8" (200 mm)
-  Support L en acier inoxydable pour installation sur tête de mât. Filetage standard 1"x14 en acier inoxydable poli, hauteur 200mm.
-  Supporto ad L in acciaio inox Aisi 316 elettrolucidato per testa ad albero, filettatura standard 1"x14, altezza 200 mm (8").

V9173

Masthead bracket in stainless steel - standard thread 1"x14

Category: Mounts & accessories

Subcategories: Masthead mounts and brackets

Code: V9173



🇺🇸 Masthead bracket in stainless steel - standard thread 1"x14

🇫🇷 Support en acier inoxydable pour l'installation sur tête de mât.

🇮🇹 Staffa in acciaio inox per installazione in testa d'albero - filettatura standard 1"x14.

RA106ADAPT1X14

Chromed adaptor - standard thread 1"x14

Category: Mounts & accessories

Subcategories: Masthead mounts and brackets

Code: RA106ADAPT1X14

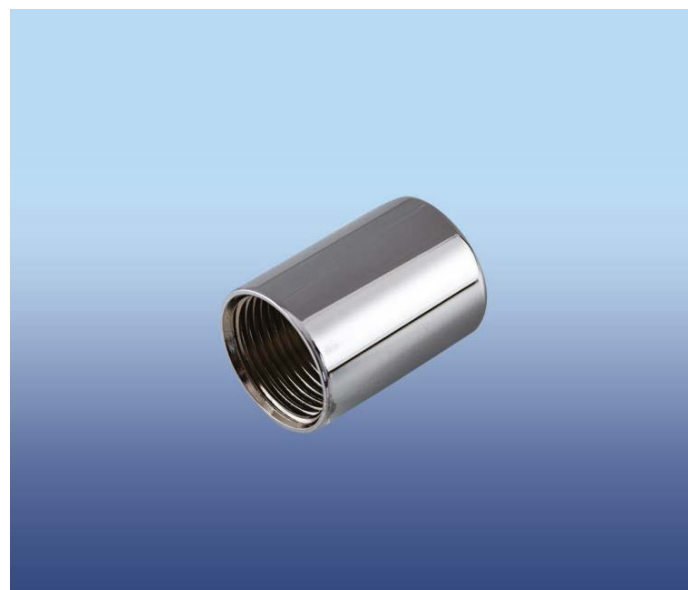

🇺🇸 Chromed adaptor for RA106 PB antennas. Standard thread 1"x14

🇫🇷 Adaptateur chromé pour les antennes RA106 PB. Filetage standard 1"x14.

🇮🇹 Adattatore cromato per antenne RA106 - Filettatura standard 1"x14.

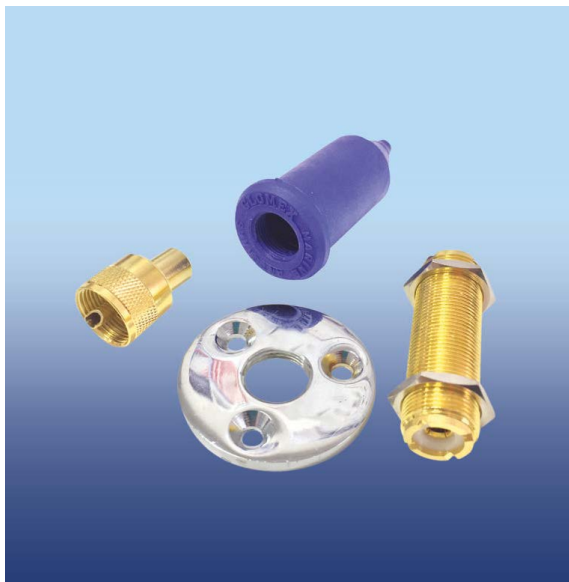

RA105

Coaxial gold plated feed - thru supplied with RA132GLOLD and RA138

Category: Mounts & accessories

Subcategories: Masthead mounts and brackets

Code: RA105U



- 🇬🇧 Coaxial Gold Plated feed-thru supplied with PVC threaded protection (RA138) for the external connector and PL259 Twist Gold Plated Connector (RA132GOLD).
- 🇫🇷 Passe-pont coaxial plaqué or et fourni avec manchon d'étanchéité caoutchouc (RA 138) pour le connecteur extérieur et connecteur PL259 plaqué or (RA132GOLD)
- 🇮🇹 Passacavo coassiale placcato oro, fornito con protezione in PVC (RA138) per connettore esterno e connettore dorato PL259 (RA132GOLD).



RA140

Nylon feed - thru with connector passage

Category: Mounts & accessories

Subcategories: Masthead mounts and brackets

Code: RA140



- 🇬🇧 Nylon feed -thru for deck passage of 1 or 2 coaxial cables and connectors.
- 🇫🇷 Obturateur/passe-fils en nylon pour 1 ou 2 cables coaxiaux et connecteurs.
- 🇮🇹 Passacavo in nylon per 1 o 2 cavi coassiali con connettore montato.

RA140U

Brass chromed feed through for cable 1/4" (6mm)

Category: Accessories

Subcategory: Deck mounts

Code: RA140U



RA179

Wind indicator for masthead or antennas RA106SLS SB and RA109 series

Category: Mounts & accessories

Subcategories: Masthead mounts and brackets

Code: RA179



🇬🇧 Wind indicator 12" (300 mm) for masthead or VHF antennas RA106SLS SB (with stainless steel whip) and RA109 series.

🇫🇷 Girouette de 300mm pour tête de mat ou antennes série RA-106SLS SB (avec un fouet en acier inoxydable) et RA109.

🇮🇹 Indicatore vento 300 mm (12") per testa d'albero o antenne VHF delle serie RA106SLS SB (con stilo in acciaio inox) e RA109.

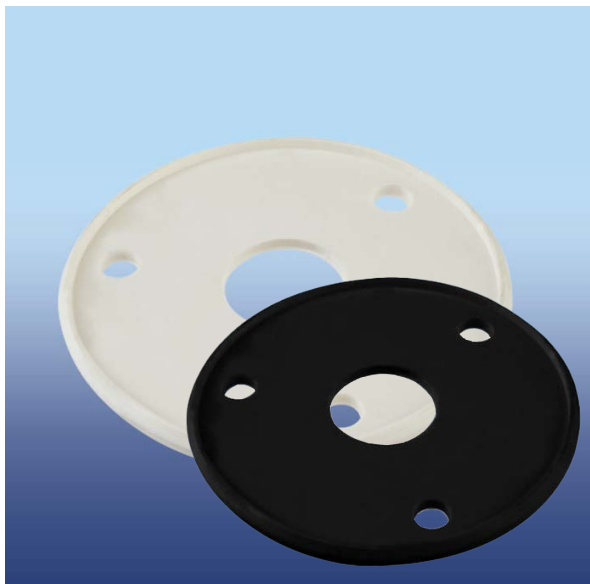

V9101/W

White rubber gasket for supports V9124, V9174 and V9177.

Category: Mounts & accessories

Subcategories: Gaskets

Code: V9101/W, V9101/B



 Synthetic rubber white gasket for alluminium surface insulation, for V9174, V9124 and V9177.

 Joint PVC pour supports V9174, V9124 et V9177.

 Guarnizione in gomma sintetica bianca per isolamento su superfici in alluminio, per supporti V9174, V9124 e V9177.

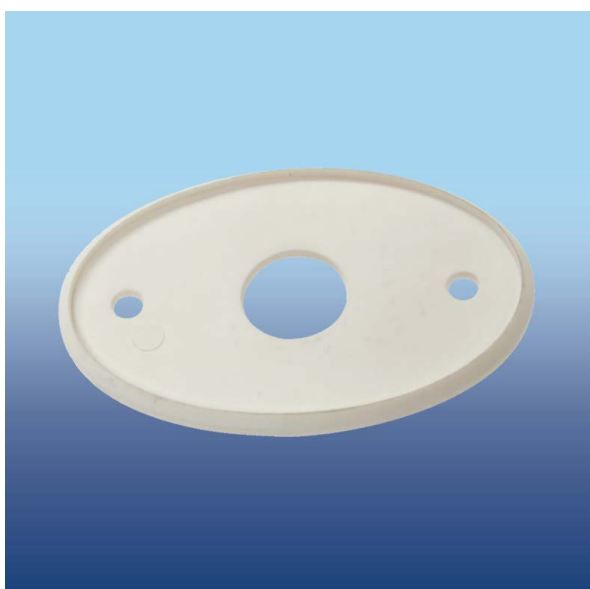

V9102

Synthetic rubber gasket for V9172.

Category: Mounts & accessories

Subcategories: Gaskets

Code: V9102



 Synthetic rubber gasket for alluminium surface insulation for V9172.

 Joint en gomme synthétique pour isoler des ponts en aluminium, pour V9172.

 Guarnizione in gomma sintetica per l'isolamento di superfici in alluminio, per V9172.

RA101

Set of 3 rectangular wedges 0-1° 0-2,5° and 0- 5° for swivel ratchet mount

Category: Mounts & accessories

Subcategories: wedges

Code: RA101

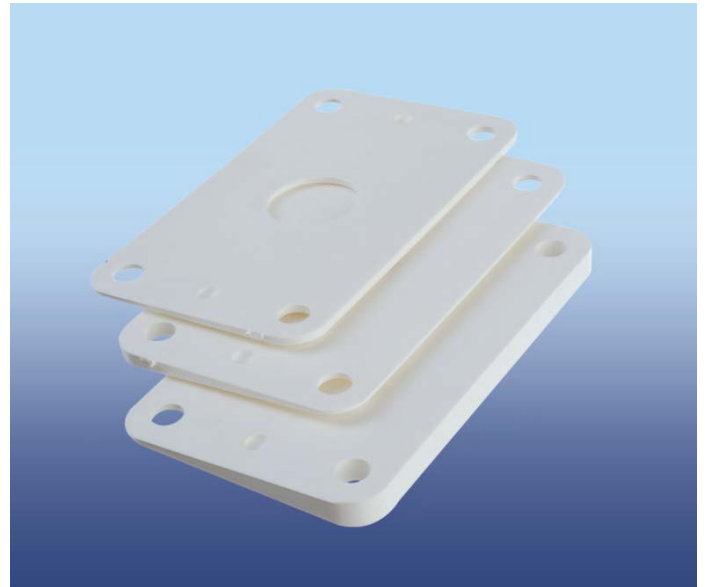

🇺🇸 Set of 3 rectangular 0-1° 0-2,5° and 0- 5° wedges for Glomex ratchet mounts to keep the antenna vertical on inclined surfaces.

🇫🇷 Jeu de 3 cales rectangulaires 0-1° 0-2,5° et 0- 5° pour supports orientables Glomex, qui permettant de maintenir l'antenne verticale sur une surface inclinée.

🇮🇹 Set 3 spessori rettangolari 0-1° 0-2,5° e 0- 5° per basi a snodo Glomex, che consentono di mantenere l'antenna in posizione verticale su superfici inclinate.

RA102

Set of 2 round wedges 0-5° for glomex universal mounts

Category: Mounts & accessories

Subcategories: wedges

Code: RA102

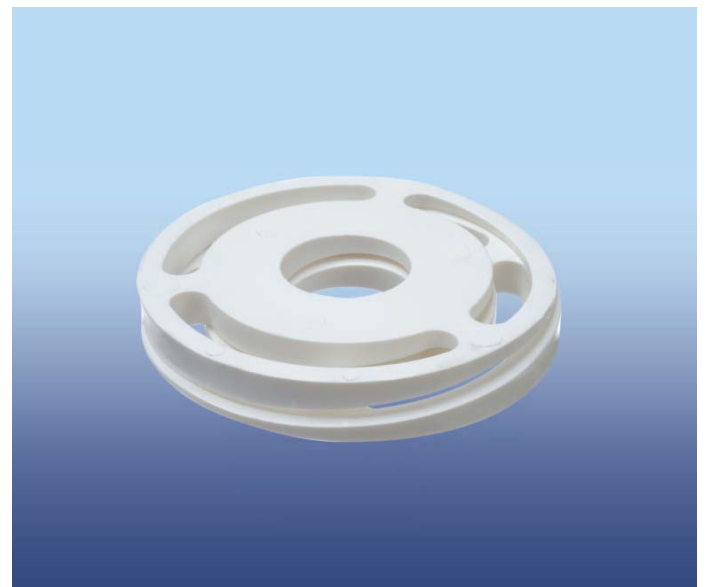

🇺🇸 Set of 2 round wedges 0-5° for glomex universal mounts. Set of 2 round wedges 0-5° for glomex universal mounts V9124, V9174, V9175 and V9177 to keep the antenna vertical on inclined surfaces.

🇫🇷 Jeu de 2 cales rondes 0-5° pour supports universel Glomex V9124, V9174, V9175 et V9177 qui maintiennent l'antenne verticale sur une surface inclinée.

🇮🇹 Set 2 spessori rotondi 0-5° per supporti universali Glomex V9124, V9174, V9175 e V9177 che permettono di mantenere l'antenna in posizione verticale su superfici inclinate.

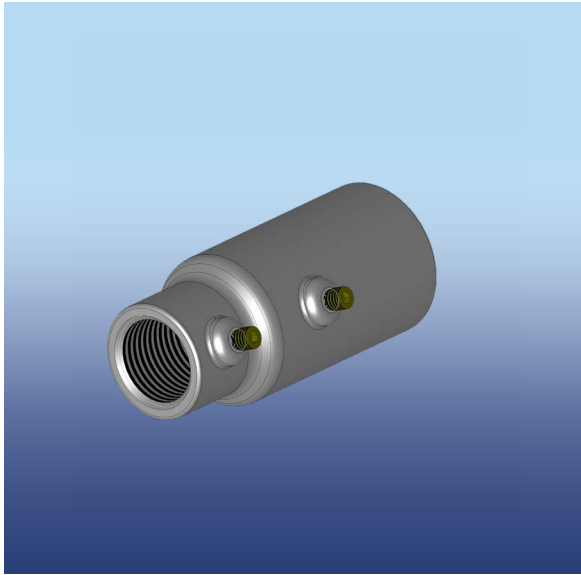

ITM003SL

Stainless steel Starlink antenna adaptor to a 1"x14 threaded. The overall height is 3 1/2" (88mm)

Category: Mounts & accessories

Subcategories: Starlink

Code: ITM003SL



OPTIONAL ACCESSORIES



▲ V9177



▲ RA107

RA138

Threaded rubber protection for PL259 connectors



Category: Mounts & accessories

Subcategories: Masthead mounts and brackets

Code: RA138



 Synthetic rubber threaded protection for PL259 connectors.

 Manchon d'étanchéité caoutchouc pour connecteurs PL259.  Protezione in gomma sintetica per connettori PL259.

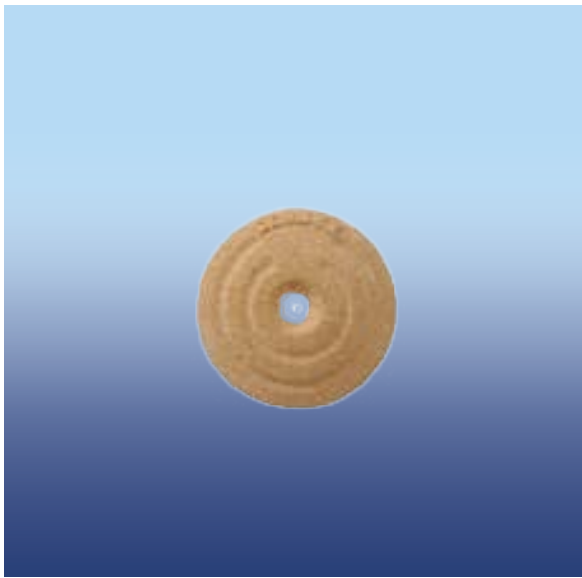

RA206

ø 55 mm (2 1/4") is conceived for tanks in order to neutralize static electricity on metal tanks or on metal parts inside of plastic tanks.



RA202

ø 128 mm (5"). Needs only one hole instead of the two needed to install rectangular plates.
Surface 1.7 m²

GENERATORS GENERAL APPLIANCES



RA203

155x51x13mm
(6x2x1/2").
Surface 1,15 m²

SUPPLIED ACCESSORIES

Bronze screw, nuts and bolts ▶

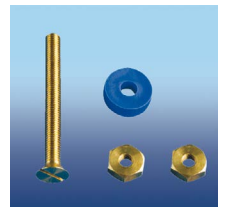

RA204

205x64x13mm
(8x2 1/2x1/2").
Surface 2 m²



RA205

300x80x13mm
(12x3x1/2").
Surface 3,45 m²



RA207

455x150x13mm (18x6x1/2").
Surface 5,75 m²



SUPPLIED ACCESSORIES

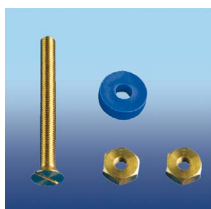

← Bronze screw, nuts
and bolts





- 🇺🇸 Glomex ground plates are the necessary interface between on board electronic devices and the heat sink: water. Ground plates are made of golden sintered phosphorous bronze, that consist of tens of thousands microspheres, joined together by an exclusive cooking mode, creating a surface tens of times than the actual one. They can have either a rectangular or a circular shape, and are fastened to the hull by means of bronze bolts and nuts, made with the same material of the ground plates, highly resistant to corrosion, and rubber spacers. The exclusive shape with hollows, offered by Glomex, assures a 15% larger surface and a better strength.
- 🇫🇷 Les plaques de masse Glomex sont une interface nécessaire entre les dispositifs électroniques de bord et l'élément de dissipation thermique: l'eau. Les plaques de masse sont faites en bronze phosphoreux fritté doré, c'est-à-dire, qu'elles se composent des dizaines de milliers de microsphères reliées entre elles par un mode de cuisson exclusif pouvant atteindre une superficie des dizaines de fois supérieure à celle de la plaque. Elles peuvent être de forme rectangulaire ou ronde et sont fixées au-dessous de la coque à l'aide de vis et d'écrous réalisé avec le même matériau que le plaques de masse, hautement résistants à la corrosion, et d'entretoises isolantes en caoutchouc. Sa forme exclusive avec des creux, conçue par Glomex, garantit une augmentation de 15% de la surface et une meilleure résistance.
- 🇮🇹 Le piastre di massa sono la necessaria interfaccia tra la strumentazione elettrica ed elettronica di bordo e l'elemento dissipatore: l'acqua. Le piastre di massa Glomex sono realizzate in bronzo fosforoso sinterizzato dorato, ovvero, sono composte da decine di migliaia di microsferi unite insieme da un esclusivo processo di cottura, sviluppando così una superficie decine di volte superiore a quella reale. Possono essere di forma rettangolare o circolare, e vengono fissate sotto la carena per mezzo di viti e dadi dello stesso materiale delle piastre di massa, altamente resistenti alla corrosione, e distanziali isolanti in gomma. La forma esclusiva composta da rientranze, inoltre, assicura un incremento del 15% della superficie ed una maggiore robustezza.



15% MORE SURFACE
thanks to the exclusive shape with hollows





MODEL	RA206	RA202	RA203	RA204	RA205	RA207
DIMENSION	Ø 55 mm (2")	Ø 128 mm (5")	155x51x13 mm (6x2x1/2")	205x64x13 mm (8x2 1/2x1/2")	300x80x13 mm (12x3x1/2")	455x150x13 mm (18x6x1/2")
WEIGHT	0,12 kg (0,3 lb)	0,6 kg (1,3 lb)	0,52 kg (1,2 lb)	0,8 kg (1,8 lb)	1,65 kg (3,6 lb)	4,2 kg (9,3 lb)
GROUND AREA EQUIVALENT		1,7 m ² (18,3 ft ²)	1,15 m ² (12,4 ft ²)	2 m ² (21,5 ft ²)	3,45 m ² (37,1 ft ²)	5,75 m ² (61,9 ft ²)
USE	Tanks in general	AC Generators general grounding	AC Generators general grounding	2 Plates SSB radio 400W AC Generators	2 Plates SSB radio 800W AC Generators	2 Plates SSB radio 800W
						 Sall Boat  Power Boat



RA103/15

150 mm (6") stainless steel antenna extension - 1"x14 standard thread

Category: Extensions

Subcategories: Stainless steel

Code: RA103/15



🇬🇧 Glomex antennas' extensions are used for vertical elevation of the antenna in order to clear the reception/transmission field. They can be made of stainless steel or UV resistant fibreglass, with standard 1"x14 thread on both sides, and they are the ideal complement to all Glomex antennas (VHF, AIS, etc.). NOT FOR GLOMEASY ANTENNAS RA103/15 is a stainless steel extension, 150 mm/6" high.

🇫🇷 Les rallonges pour antennes Glomex sont utilisées pour élever verticalement l'antenne et rendre la zone de réception/transmission libre. Elle peuvent être en acier inoxydable ou en fibre de verre peinte en polyuréthane, avec filetage standard 1"x14, et sont le complément parfaitement pour toutes les antennes à fouet Glomex (VHF, AIS, etc.) sauf les antennes Glomeasy. RA103/15 est une rallonge en acier inoxydable, haute 150 mm.

🇮🇹 Le piastre di massa sono la necessaria interfaccia tra la strumentazione elettronica di bordo e l'elemento dissipatore: l'acqua. Le piastre di massa Glomex sono realizzate in bronzo dorato sinterizzato, ovvero, sono composte da milioni di microsferiche che sviluppano una superficie fino a 10 volte superiore a quella reale. Possono essere di forma rettangolare o circolare, e vengono fissate sotto la carena per mezzo di viti e dadi in bronzo, altamente resistenti alla corrosione, e distanziali isolanti in gomma. La forma esclusiva proposta da Glomex assicura una maggiore superficie ed una maggiore robustezza.

RA103/30

300 mm (12") stainless steel antenna extension - 1"x14 standard thread

Category: Extensions

Subcategories: Stainless steel

Code: RA103/30

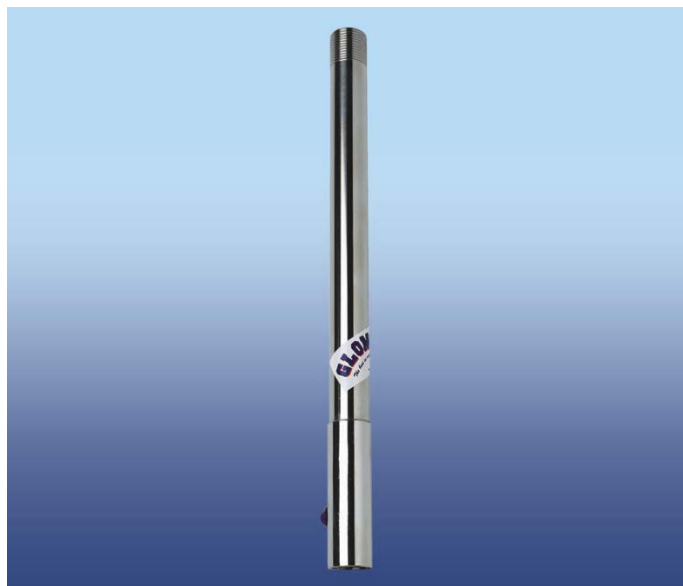

🇺🇸 Glomex antennas' extensions are used for vertical elevation of the antenna in order to clear the reception/transmission field. They can be made of stainless steel or UV resistant fibreglass, with standard 1"x14 thread on both sides, and they are the ideal complement to all Glomex antennas (VHF, AIS, etc.). NOT FOR GLOMEASY ANTENNAS RA103/30 is a stainless steel extension, 300 mm/12" high.

🇫🇷 Les rallonges pour antennes Glomex sont utilisées pour élever verticalement l'antenne et rendre la zone de réception/transmission libre. Elle peuvent être en acier inoxydable ou en fibre de verre peinte en polyuréthane, avec filetage standard 1"x14, et sont le complément parfaitement pour toutes les antennes à fouet Glomex (VHF, AIS, etc.) sauf les antennes Glomeasy. RA103/30 est une rallonge en acier inoxydable, haute 300 mm.

🇮🇹 Le piastre di massa sono la necessaria interfaccia tra la strumentazione elettronica di bordo e l'elemento dissipatore: l'acqua. Le piastre di massa Glomex sono realizzate in bronzo dorato sinterizzato, ovvero, sono composte da milioni di microsferiche che sviluppano una superficie fino a 10 volte superiore a quella reale. Possono essere di forma rettangolare o circolare, e vengono fissate sotto la carena per mezzo di viti e dadi in bronzo, altamente resistenti alla corrosione, e distanziali isolanti in gomma. La forma esclusiva proposta da Glomex assicura una maggiore superficie ed una maggiore robustezza.

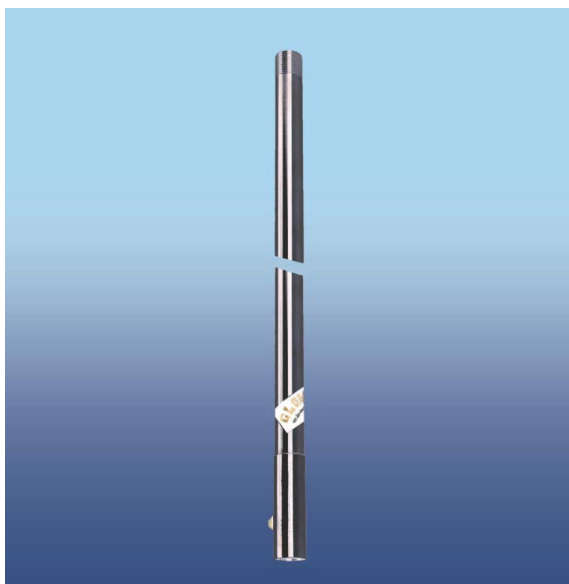

RA103/60

600 mm (24") stainless steel antenna extension - 1"x14 standard thread

Category: Extensions

Subcategories: Stainless steel

Code: RA103/60



🇬🇧 Glomex antennas' extensions are used for vertical elevation of the antenna in order to clear the reception/transmission field. They can be made of stainless steel or UV resistant fibreglass, with standard 1"x14 thread, and they are the ideal complement to all Glomex antennas (VHF, AIS, etc.). RA103/60 is a stainless steel extension, 600 mm/24" high.

🇫🇷 Les rallonges pour antennes Glomex sont utilisées pour élever verticalement l'antenne et rendre la zone de réception/transmission libre. Elle peuvent être en acier inoxydable ou en fibre de verre peinte en polyuréthane, avec filetage standard 1"x14, et sont le complément parfaitement pour toutes les antennes à fouet Glomex (VHF, AIS, etc.) sauf les antennes Glomeasy. RA103/60 est une rallonge en acier inoxydable, haute 600 mm.

🇮🇹 Le prolunghe per antenne Glomex sono utilizzate per elevare verticalmente l'antenna, liberando il campo di ricezione/trasmisione. Possono essere in acciaio inox Aisi 316, o in fibra di vetro verniciata in poliuretano, con filettatura standard 1"X 14 in entrambe le terminazioni e sono il completamento ideale per tutte le antenne a stilo Glomex (VHF, AIS, etc.). NON PER ANTENNE GLOMEASY RA103/15 è una prolunga in acciaio inox Aisi 316, alta 150 mm/6".

RA120

2 m (6.6') Fibreglass antenna extension - 1"x14 standard thread

Category: Extensions

Subcategories: Fiberglass

Code: RA120



🇬🇧 Glomex antennas' extensions are used for vertical elevation of the antenna in order to clear the reception/transmission field. They can be made of stainless steel or UV resistant fibreglass, with standard 1"x14 thread, and they are the ideal complement to all Glomex antennas (VHF, AIS, etc.). RA120 is a fibreglass extension, 2 m/6,6' high.

🇫🇷 Les rallonges pour antennes Glomex sont utilisées pour élever verticalement l'antenne et rendre la zone de réception/transmission libre. Elle peuvent être en acier inoxydable ou en fibre de verre peinte en polyuréthane, avec filetage standard 1"x14, et sont le complément parfaitement pour toutes les antennes à fouet Glomex (VHF, AIS, etc.). RA120 est une rallonge en fibre de verre, haute.

🇮🇹 Le prolunghe per antenne Glomex sono utilizzate per elevare verticalmente l'antenna, liberando il campo di ricezione/trasmissione. Possono essere in acciaio inox Aisi 316, o in fibra di vetro verniciata in poliuretano, con filettatura standard 1"X 14 in entrambe le terminazioni e sono il completamento ideale per tutte le antenne a stilo Glomex (VHF, AIS, etc.). NON PER ANTENNE GLOMEASY. RA123 è una prolunga in acciaio inox Aisi 316, alta 1,5 m/5'.



RA122/60

600 mm (24") fibreglass antenna extension - 1"x14 standard thread

Category: Extensions

Subcategories: Fiberglass

Code: RA122/60



🇬🇧 Glomex antennas' extensions are used for vertical elevation of the antenna in order to clear the reception/transmission field. They can be made of stainless steel or UV resistant fibreglass, with standard 1"x14 thread, and they are the ideal complement to all Glomex antennas (VHF, AIS, etc.), NOT FOR GLOMEASY ANTENNAS RA122/60 is a fibreglass extension, 600 mm/24" high.

🇫🇷 Les rallonges pour antennes Glomex sont utilisées pour élever verticalement l'antenne et rendre la zone de réception/transmission libre. Elle peuvent être en acier inoxydable ou en fibre de verre peinte en polyuréthane, avec filetage standard 1"x14, et sont le complément parfaitement pour toutes les antennes à fouet Glomex (VHF, AIS, etc.) sauf les antennes Glomeasy. RA122/60 est une rallonge en fibre de verre, haute 600mm.

🇮🇹 Le prolunghe per antenne Glomex sono utilizzate per elevare verticalmente l'antenna, liberando il campo di ricezione/trasmisione. Possono essere in acciaio inox Aisi 316, o in fibra di vetro verniciata in poliuretano, con filettatura standard 1"X 14 e sono il completamento ideale per tutte le antenne a stilo Glomex (VHF, AIS, etc.). RA103/60 è una prolunga in acciaio inox Aisi 316, alta 600 mm/24".

RA149

1,2 m (4') fibreglass antenna extension - 1"x14 standard thread

Category: Extensions

Subcategories: Fiberglass

Code: RA149



🇺🇸 Glomex antennas' extensions are used for vertical elevation of the antenna in order to clear the reception/transmission field. They can be made of stainless steel or UV resistant fibreglass, with standard 1"x14 thread on both sides and they are the ideal complement to all Glomex antennas (VHF, AIS, etc.). NOT FOR GLOMEASY ANTENNAS LINE RA149 is a fibreglass extension, 1.2 m/4' high.

🇫🇷 Les rallonges pour antennes Glomex sont utilisées pour élever verticalement l'antenne et rendre la zone de réception/transmission libre. Elle peuvent être en acier inoxydable ou en fibre de verre peinte en polyuréthane, avec filetage standard 1"x14, et sont le complément parfaitement pour toutes les antennes à fouet Glomex (VHF, AIS, etc.) sauf les antennes Glomeasy. RA149 est une rallonge en fibre de verre, haute 1,2m.

🇮🇹 Glomex antennas' extensions are used for vertical elevation of the antenna in order to clear the reception/transmission field.. They can be made of stainless steel or UV resistant fibreglass, with standard 1"x14 thread on both sides, and they are the ideal complement to all Glomex antennas (VHF, AIS, etc.). NOT FOR GLOMEASY ANTENNAS. RA123 is a stainless steel extension, 1,5 m/5' high.



RA129/15

150 mm (6") - white paint aluminium extension for GPS antennas - 1"x14 standard thread

Category: Extensions

Subcategories: Aluminium

Code: RA129/15



🇬🇧 Alluminium extensions in glossy white paint for GPS antennas. They're available in various lengths, with standard 1"x14 thread, allow the central and side passage of the GPS antenna cable. RA129/15 is an extension 150 mm/6" high.

🇫🇷 Rallonges en aluminium laqué blanc spécifiques pour antennes GPS. Elles sont disponibles en différentes longueurs, avec filetage standard 1"X 14, et elles permettent le passage centrale et latérale de câble. RA129/15 est une rallonge, haute 150 mm.

🇮🇹 Le prolunghe per antenne Glomex sono utilizzate per elevare verticalmente l'antenna, liberando il campo di ricezione/trasmisione. Possono essere in acciaio inox, o in fibra di vetro verniciata in poliuretano, con filettatura standard 1"X 14 e sono il completamento ideale per tutte le antenne a stilo Glomex (VHF, AIS, etc.). RA120 è una prolunga in fibra di vetro, alta 2 m/6,6'.



RA129/30

300 mm (12") - white paint aluminium extension for GPS antennas - 1"x14 standard thread

Category: Extensions

Subcategories: Aluminium

Code: RA129/30



🇬🇧 Alluminium extensions in glossy white paint for GPS antennas. They're available in various lengths, with standard 1"x14 thread, allow the central and side passage of the GPS antenna cable. RA129/30 is an extension 300 mm/12" high.

🇫🇷 Rallonges en aluminium laqué blanc spécifiques pour antennes GPS. Elles sont disponibles en différentes longueurs, avec filetage standard 1"X 14, et elles permettent le passage centrale et latérale de câble. RA129/30 est une rallonge, haute 300mm.

🇮🇹 Le prolunghe per antenne Glomex sono utilizzate per elevare verticalmente l'antenna, liberando il campo di ricezione/trasmisione. Possono essere in acciaio inox, o in fibra di vetro verniciata in poliuretano, con filettatura standard 1"X 14 in entrambe le terminazioni e sono il completamento ideale per tutte le antenne a stilo Glomex (VHF, AIS, etc.). NON PER LE ANTENNE GLOMEASY RA150 è una prolunga in fibra di vetro, alta 2,4 m/8'.

RA129/60

600 mm (24") - white paint aluminium extension for GPS antennas - 1"x14 standard thread

Category: Extensions

Subcategories: Aluminium

Code: RA129/60



🇬🇧 Alluminium extensions in glossy white paint for GPS antennas. They're available in various lengths, with standard 1"x14 thread, allow the central and side passage of the GPS antenna cable. RA129/60 is an extension 600 mm/24" high.

🇫🇷 Rallonges en aluminium laqué blanc spécifiques pour antennes GPS. Elles sont disponibles en différentes longueurs, avec filetage standard 1"X 14, et elles permettent le passage centrale et latérale de cable. RA129/60 est une rallonge, haute 600mm.

🇮🇹 Prolunghe in alluminio laccato bianco specifiche per le antenne GPS. Sono disponibili diverse lunghezze, con filettatura standard 1"X 14, e permettono il passaggio centrale e laterale del cavo. RA129/15 è una prolunga alta 150 mm/6".

RA129/120

1,2 m (4') - white paint aluminium extension for GPS antennas - 1"x14 standard thread

Category: Extensions

Subcategories: Aluminium

Code: RA129/120



🇬🇧 Alluminium extensions in glossy white paint for GPS antennas. They're available in various lengths, with standard 1"x14 thread, allow the central and side passage of the GPS antenna cable. RA129/120 is an extension 1,2 m/4' high.

🇫🇷 Rallonges en aluminium laqué blanc spécifiques pour antennes GPS. Elles sont disponibles en différentes longueurs, avec filetage standard 1"X 14, et elles permettent le passage centrale et latérale de cable. RA129/120 est une rallonge, haute 1,2m.

🇮🇹 Prolunghe in alluminio laccato bianco specifiche per le antenne GPS. Sono disponibili diverse lunghezze, con filettatura standard 1"X 14, e permettono il passaggio centrale e laterale del cavo. RA129/30 è una prolunga alta 300 mm/12".

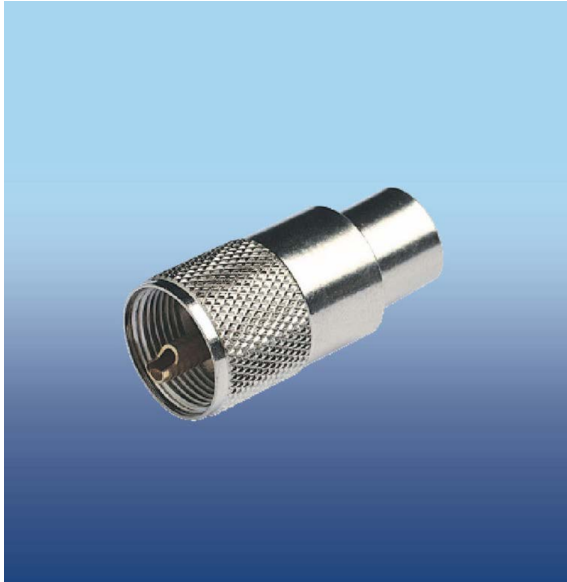

RA131

PL-259 male connector for RG213/U cable (VHF)

Category: Connectors

Subcategories: 50 Ohm

Code: RA131



 PL-259 male connector for RG213/U cable (VHF)

 Connecteur PL259 mâle pour câble RG213/U (VHF).

 Connettore PL-259 maschio per cavo RG213/U (VHF)



RA132

PL-259 male connector for RG58/U cable (VHF/CB).
Twist on

Category: Connectors

Subcategories: 50 Ohm

Code: RA132



 PL-259 male connector for RG58/U cable (VHF/CB). Twist on

 Connecteur PL259 mâle pour câble RG58/U (VHF/CB).

 Connettore PL259 maschio per cavo RG213/U (VHF)

RA131GOLD

Gold plated PL-259 male connector for RG213/U cable (VHF)

Category: Connectors

Subcategories: 50 Ohm

Code: RA131GOLD



 Gold plated PL-259 male connector for RG213/U cable (VHF)

 Connecteur PL259 mâle pour câble RG213/U. Plaqué or.

 Connettore PL-259 maschio, placcato oro, per cavo RG213/U (VHF)

RA132GOLD

Gold plated PL-259 male connector, twist on for RG58/U cable

Category: Connectors

Subcategories: 50 Ohm

Code: RA132GOLD



 Gold plated PL-259 male connector, twist on for RG58/U cable

 Connecteur PL259 mâle plaqué or pour câble RG58/U.

 Connettore PL259 maschio dorato per cavo RG213/U (VHF)



RA132SOLDERLESS

Solderless PL-259 male gold plated connector for RG58C/U

Category: Connectors

Subcategories: 50 Ohm

Code: RA132SOLDERLESS



 Solderless PL-259 male gold plated connector for RG58/U cable

 Connecteur PL-259 sans soudure. Plaqué or. Pour RG58C/U.

 Connettore PL-259 maschio senza saldatura, placcato oro, per cavo RG58/U (VHF/CB)



RA133GOLD

Gold plated PL-258 double female connector for PL-259 (VHF/CB)

Category: Connectors

Subcategories: 50 Ohm

Code: RA133GOLD



 Gold plated PL-258 double female connector for PL-259 (VHF/CB)

 PL258 double femelle connecteur pour PL259. Plaqué or(VHF/CB).

 Connettore PL-258 doppia femmina per PL-259. Placcato oro (VHF/CB)

RA133

PL-258 double female connector for PL-259. Nickel plated (VHF/CB)

Category: Connectors

Subcategories: 50 Ohm

Code: RA133



🇺🇸 PL-258 double female connector for PL-259. Nickel plated (VHF/CB)

🇫🇷 PL258 double femelle connecteur pour PL259. Plaqué nickel (VHF/CB).

🇮🇹 Connettore PL-258 doppia femmina per PL-259. Nichelato (VHF/CB)

RA155

BNC female to TNC male adaptor (cell)

Category: Connectors

Subcategories: 50 Ohm

Code: RA155



🇺🇸 BNC female to TNC male adaptor (cell)

🇫🇷 Connecteur adaptateur BNC femelle/TNC mâle (cell).

🇮🇹 Connettore/adattatore BNC femmina / TNC maschio (cell)



RA153

BNC female connector for RG-213U (cellular). 50 Ohms

Category: Connectors

Subcategories: 50 Ohm

Code: RA153



 BNC female connector for RG-213U (cellular). 50 Ohms

 Connecteur BNC mâle - nickelé pour RG213U. 50 Ohms

 Connettore BNC maschio, nichelato, per cavo RG214/U. 50 Ohms



RA157

Mini UHF male connector for RG-58C/U (cell)

Category: Connectors

Subcategories: 50 Ohm

Code: RA157



 Mini UHF male connector for RG-58C/U (cell)

 Mini connecteur UHF mâle pour câble RG58C/U (cell).

 Mini connettore UHF per cavo RG58C/U (cell)

RA156

TNC male connector for RG-58C/U (cell)

Category: Connectors

Subcategories: 50 Ohm

Code: RA156



 TNC male connector for RG-58C/U (cell)

 Connecteur TNC mâle pour câble RG58C/U (cell).



 Connettore TNC maschio per cavo RG58C/U (cell)

RA159

N female to TNC female adaptor

Category: Connectors

Subcategories: 50 Ohm

Code: RA159



 N female to TNC female adaptor

 Adaptateur N femelle/TNC femelle



 Adattatore N femmina / TNC femmina



RA158

N male connector for RG-213/U cable (CELL/VHF)

Category: Connectors

Subcategories: 50 Ohm

Code: RA158



 N male connector for RG-213/U cable (CELL/VHF)

 Connecteur N mâle pour câble rg213/u (cell/vhf).

 Connettore N maschio per cavo RG-213/U (cell/VHF)



V9137

Gold plated 9.5mm IEC male connector for TV cable

Category: Connectors

Subcategories: 75 Ohm

Code: V9137



 Gold plated 9.5mm IEC male connector for TV cable

 Connecteur IEC femelle 9.5mm plaqué or pour câble TV

 Connettore IEC femmina 9,5mm, placcato oro, per cavo TV

RA163

Gold plated F/F female connector to extend TV cable

Category: Connectors

Subcategories: 75 Ohm

Code: RA163



 Gold plated F/F female connector to extend TV cable

 Connecteur F/F femelle plaqué or pour prolonger le câble TV

 Connettore F/F femmina, placcato oro, per prolunga cavo TV

V9141

F female / IEC 9,5mm male adaptor for TV cable

Category: Connectors

Subcategories: 75 Ohm

Code: V9141



 F female / IEC 9,5mm male adaptor for TV cable

 Adaptateur F femelle / IEC 9,5mm pour câble TV

 Adattatore F femmina / IEC 9,5mm maschio per cavo TV



V9137/F

9.5mm IEC female connector for TV cable

Category: Connectors

Subcategories: 75 Ohm

Code: V9137/F



 9.5mm IEC female connector for TV cable

 Connecteur IEC femelle 9.5mm IEC pour câble TV

 Connettore IEC femmina 9,5mm per cavo TV



V9145

F termination - 75 Ohms

Category: Connectors

Subcategories: 75 Ohm

Code: V9145



 F termination – 75 Ohms

 Charge F - 75 Ohms

 Tappo di chiusura F – 75 Ohms

V9144

Male gold plated connector for RG-59/U and V9135 Glomex coax cables

Category: Connectors

Subcategories: 75 Ohm

Code: V9144



🇺🇸 Male gold plated connector for RG-59/U and V9135 Glomex coax cables

🇫🇷 Connecteur mâle plaqué or pour les câbles coaxiales RG-59/U et V9135

🇮🇹 Connettore maschio placcato oro per cavi coassiali RG-59/U e V9135 Glomex

V9146

F female to F male 90° adaptor for F male/female connectors

Category: Connectors

Subcategories: 75 Ohm

Code: V9146



🇺🇸 F female to F male 90° adaptor for F male/female connectors – nickel plated

🇫🇷 Adaptateur 90° F femelle/F mâle pour connecteurs F mâle/femelle – nickelé

🇮🇹 Adattatore 90° da F femmina a F maschio per connettori F maschio/femmina



RA117

100 m (328') RG-58/U mil C17 white coax cable

Category: Coax cables

Subcategories: 50 Ohm

Code: RA117



🇬🇧 Coaxial cables transmit signals to and from the antenna. Poor quality cables will dramatically reduce the efficiency of both antenna and transceivers. All coaxial cables can lose efficiency over time due to humidity. Glomex cables are specifically designed and manufactured for use in the marine environment. All Glomex cables have been developed in cooperation with coaxial cables specialists to ensure minimal signal distortion or loss and long term reliability.

🇫🇷 Les câbles coaxiaux transmettent les signaux vers l'antenne et vice-versa. Les câbles coaxiaux peuvent perdre de leur efficacité avec le temps dans un milieu humide, mais les câbles Glomex sont conçus et fabriqués spécialement pour être utilisés dans un milieu marin et pour résister aussi longtemps aux effets négatifs du brouillard salin. Tous les câbles Glomex ont été développés en coopération avec des spécialistes du câble coaxial pour minimiser la distorsion et la perte de la qualité du signal et assurer une fiabilité à long terme.

🇮🇹 I cavi coassiali costituiscono l'elemento che trasferisce il segnale dall'antenna al ricevitore/trasmittitore. Cavi di qualità scadente e di lunghezza elevata possono quindi compromettere il buon funzionamento di una antenna, vanificandone l'efficienza con il risultato di prestazioni insufficienti indipendentemente dalle caratteristiche dell'antenna. Altro elemento di grande importanza per i cavi coassiali è la perdita di efficacia nel tempo a causa dell'umidità: Glomex, per questi motivi, ha progettato e produce cavi specifici per l'ambiente marino. Tutti i cavi coassiali Glomex sono studiati in collaborazione con il produttore di cavi, per garantire una bassa attenuazione nel lungo periodo ed elevata qualità.

RA118

100 m (328') RG-213/U mil C17 white coax cable

Category: Coax cables

Subcategories: 50 Ohm

Code: RA118



🇬🇧 Coaxial cables transmit signals to and from the antenna. Poor quality cables will dramatically reduce the efficiency of both antenna and transceivers. All coaxial cables can lose efficiency over time due to humidity. Glomex cables are specifically designed and manufactured for use in the marine environment. All Glomex cables have been developed in cooperation with coaxial cables specialists to ensure minimal signal distortion or loss and long term reliability.

🇫🇷 Les câbles coaxiaux transmettent les signaux vers l'antenne et vice-versa. Les câbles coaxiaux peuvent perdre de leur efficacité avec le temps dans un milieu humide, mais les câbles Glomex sont conçus et fabriqués spécialement pour être utilisés dans un milieu marin et pour résister aussi longtemps aux effets négatifs du brouillard salin. Tous les câbles Glomex ont été développés en coopération avec des spécialistes du câble coaxial pour minimiser la distorsion et la perte de la qualité du signal et assurer une fiabilité à long terme.

🇮🇹 I cavi coassiali costituiscono l'elemento che trasferisce il segnale dall'antenna al ricevitore/trasmittitore. Cavi di qualità scadente e di lunghezza elevata possono quindi compromettere il buon funzionamento di una antenna, vanificandone l'efficienza con il risultato di prestazioni insufficienti indipendentemente dalle caratteristiche dell'antenna. Altro elemento di grande importanza per i cavi coassiali è la perdita di efficacia nel tempo a causa dell'umidità: Glomex, per questi motivi, ha progettato e produce cavi specifici per l'ambiente marino. Tutti i cavi coassiali Glomex sono studiati in collaborazione con il produttore di cavi, per garantire una bassa attenuazione nel lungo periodo ed elevata qualità.



RA152/10

10 m (33') RG-58ALL white low loss coax cable

Category: Coax cables

Subcategories: 50 Ohm

Code: RA152/10



Coaxial cables transmit signals to and from the antenna. Poor quality cables will dramatically reduce the efficiency of both antenna and transceivers. All coaxial cables can lose efficiency over time due to humidity. Glomex cables are specifically designed and manufactured for use in the marine environment. All Glomex cables have been developed in cooperation with coaxial cables specialists to ensure minimal signal distortion or loss and long term reliability.

Les câbles coaxiaux transmettent les signaux vers l'antenne et vice-versa. Les câbles coaxiaux peuvent perdre de leur efficacité avec le temps dans un milieu humide, mais les câbles Glomex sont conçus et fabriqués spécialement pour être utilisés dans un milieu marin et pour résister aussi longtemps aux effets négatifs du brouillard salin. Tous les câbles Glomex ont été développés en coopération avec des spécialistes du câble coaxial pour minimiser la distorsion et la perte de la qualité du signal et assurer une fiabilité à long terme.

I cavi coassiali costituiscono l'elemento che trasferisce il segnale dall'antenna al ricevitore/trasmittitore. Cavi di qualità scadente e di lunghezza elevata possono quindi compromettere il buon funzionamento di una antenna, vanificandone l'efficienza con il risultato di prestazioni insufficienti indipendentemente dalle caratteristiche dell'antenna. Altro elemento di grande importanza per i cavi coassiali è la perdita di efficacia nel tempo a causa dell'umidità: Glomex, per questi motivi, ha progettato e produce cavi specifici per l'ambiente marino. Tutti i cavi coassiali Glomex sono studiati in collaborazione con il produttore di cavi, per garantire una bassa attenuazione nel lungo periodo ed elevata qualità.

RA152

100 m (328') RG-58ALL white low loss coax cable

Category: Coax cables

Subcategories: 50 Ohm

Code: RA152



🇬🇧 Coaxial cables transmit signals to and from the antenna. Poor quality cables will dramatically reduce the efficiency of both antenna and transceivers. All coaxial cables can lose efficiency over time due to humidity. Glomex cables are specifically designed and manufactured for use in the marine environment. All Glomex cables have been developed in cooperation with coaxial cables specialists to ensure minimal signal distortion or loss and long term reliability.

🇫🇷 Les câbles coaxiaux transmettent les signaux vers l'antenne et vice-versa. Les câbles coaxiaux peuvent perdre de leur efficacité avec le temps dans un milieu humide, mais les câbles Glomex sont conçus et fabriqués spécialement pour être utilisés dans un milieu marin et pour résister aussi longtemps aux effets négatifs du brouillard salin. Tous les câbles Glomex ont été développés en coopération avec des spécialistes du câble coaxial pour minimiser la distorsion et la perte de la qualité du signal et assurer une fiabilité à long terme.

🇮🇹 I cavi coassiali costituiscono l'elemento che trasferisce il segnale dall'antenna al ricevitore/trasmittitore. Cavi di qualità scadente e di lunghezza elevata possono quindi compromettere il buon funzionamento di una antenna, vanificandone l'efficienza con il risultato di prestazioni insufficienti indipendentemente dalle caratteristiche dell'antenna. Altro elemento di grande importanza per i cavi coassiali è la perdita di efficacia nel tempo a causa dell'umidità: Glomex, per questi motivi, ha progettato e produce cavi specifici per l'ambiente marino. Tutti i cavi coassiali Glomex sono studiati in collaborazione con il produttore di cavi, per garantire una bassa attenuazione nel lungo periodo ed elevata qualità.



V9135

100 m (328') 75 Ohm white low loss and twin screening TV coax cable

Category: Coax cables

Subcategories: 75 Ohm

Code: V9135



Coaxial cable is the component for transferring signal from the antenna to the receiver/sender. Low quality and very long cables can impair the operation of a good antenna, by reducing efficiency, and for this reason Glomex have designed coaxial cables specifically for application in the marine environment and in a high quality to ensure long lasting performance.

Les câbles coaxiaux transmettent les signaux vers l'antenne et vice-versa. Les câbles coaxiaux peuvent perdre de leur efficacité avec le temps dans un milieu humide, mais les câbles Glomex sont conçus et fabriqués spécialement pour être utilisés dans un milieu marin et pour résister aussi longtemps aux effets négatifs du brouillard salin. Tous les câbles Glomex ont été développés en coopération avec des spécialistes du câble coaxial pour minimiser la distorsion et la perte de la qualité du signal et assurer une fiabilité à long terme.

I cavi coassiali costituiscono l'elemento che trasferisce il segnale dall'antenna al ricevitore/trasmittitore. Cavi di qualità scadente e di lunghezza elevata possono quindi compromettere il buon funzionamento di una antenna, vanificandone l'efficienza con il risultato di prestazioni insufficienti indipendentemente dalle caratteristiche dell'antenna. Altro elemento di grande importanza per i cavi coassiali è la perdita di efficacia nel tempo a causa dell'umidità: Glomex, per questi motivi, ha progettato e produce cavi specifici per l'ambiente marino. Tutti i cavi coassiali Glomex sono studiati in collaborazione con il produttore di cavi, per garantire una bassa attenuazione nel lungo periodo ed elevata qualità.

RA152/20

20 m (66') RG-58ALL white low loss coax cable

Category: Coax cables

Subcategories: 50 Ohm

Code: RA152/20



🇬🇧 Coaxial cables transmit signals to and from the antenna. Poor quality cables will dramatically reduce the efficiency of both antenna and transceivers. All coaxial cables can lose efficiency over time due to humidity. Glomex cables are specifically designed and manufactured for use in the marine environment. All Glomex cables have been developed in cooperation with coaxial cables specialists to ensure minimal signal distortion or loss and long term reliability.

🇫🇷 Les câbles coaxiaux transmettent les signaux vers l'antenne et vice-versa. Les câbles coaxiaux peuvent perdre de leur efficacité avec le temps dans un milieu humide, mais les câbles Glomex sont conçus et fabriqués spécialement pour être utilisés dans un milieu marin et pour résister aussi longtemps aux effets négatifs du brouillard salin. Tous les câbles Glomex ont été développés en coopération avec des spécialistes du câble coaxial pour minimiser la distorsion et la perte de la qualité du signal et assurer une fiabilité à long terme.

🇮🇹 I cavi coassiali costituiscono l'elemento che trasferisce il segnale dall'antenna al ricevitore/trasmittitore. Cavi di qualità scadente e di lunghezza elevata possono quindi compromettere il buon funzionamento di una antenna, vanificandone l'efficienza con il risultato di prestazioni insufficienti indipendentemente dalle caratteristiche dell'antenna. Altro elemento di grande importanza per i cavi coassiali è la perdita di efficacia nel tempo a causa dell'umidità: Glomex, per questi motivi, ha progettato e produce cavi specifici per l'ambiente marino. Tutti i cavi coassiali Glomex sono studiati in collaborazione con il produttore di cavi, per garantire una bassa attenuazione nel lungo periodo ed elevata qualità.



V9139/20

20 m (66') 75 Ohm white low loss and twin screening TV coax cable

Category: Coax cables

Subcategories: 75 Ohm

Code: V9139/20



🇬🇧 Coaxial cables transmit signals to and from the antenna. Poor quality cables will dramatically reduce the efficiency of both antenna and transceivers. All coaxial cables can lose efficiency over time due to humidity. Glomex cables are specifically designed and manufactured for use in the marine environment. All Glomex cables have been developed in cooperation with coaxial cables specialists to ensure minimal signal distortion or loss and long term reliability. Connectors are not included.

🇫🇷 Les câbles coaxiaux transmettent les signaux vers l'antenne et vice-versa. Les câbles coaxiaux peuvent perdre de leur efficacité avec le temps dans un milieu humide, mais les câbles Glomex sont conçus et fabriqués spécialement pour être utilisés dans un milieu marin et pour résister aussi longtemps aux effets négatifs du brouillard salin. Tous les câbles Glomex ont été développés en coopération avec des spécialistes du câble coaxial pour minimiser la distorsion et la perte de la qualité du signal et assurer une fiabilité à long terme. Connecteurs pas inclus.

🇮🇹 I cavi coassiali costituiscono l'elemento che trasferisce il segnale dall'antenna al ricevitore/trasmittitore. Cavi di qualità scadente e di lunghezza elevata possono quindi compromettere il buon funzionamento di una antenna, vanificandone l'efficienza con il risultato di prestazioni insufficienti indipendentemente dalle caratteristiche dell'antenna. Altro elemento di grande importanza per i cavi coassiali è la perdita di efficacia nel tempo a causa dell'umidità: Glomex, per questi motivi, ha progettato e produce cavi specifici per l'ambiente marino. Tutti i cavi coassiali Glomex sono studiati in collaborazione con il produttore di cavi, per garantire una bassa attenuazione nel lungo periodo ed elevata qualità.



GLOMEASY

Glomeasy line concept

Fast fitting system

All Glomeasy VHF/FM/AIS/DAB marine antennas have a special FME fast fitting termination which allows a quick and easy installation of the antenna. Each Glomeasy coax cable does

not need to be altered, as it is terminated on each end with a professional grade, high quality and rugged FME connector that does not need to be soldered.

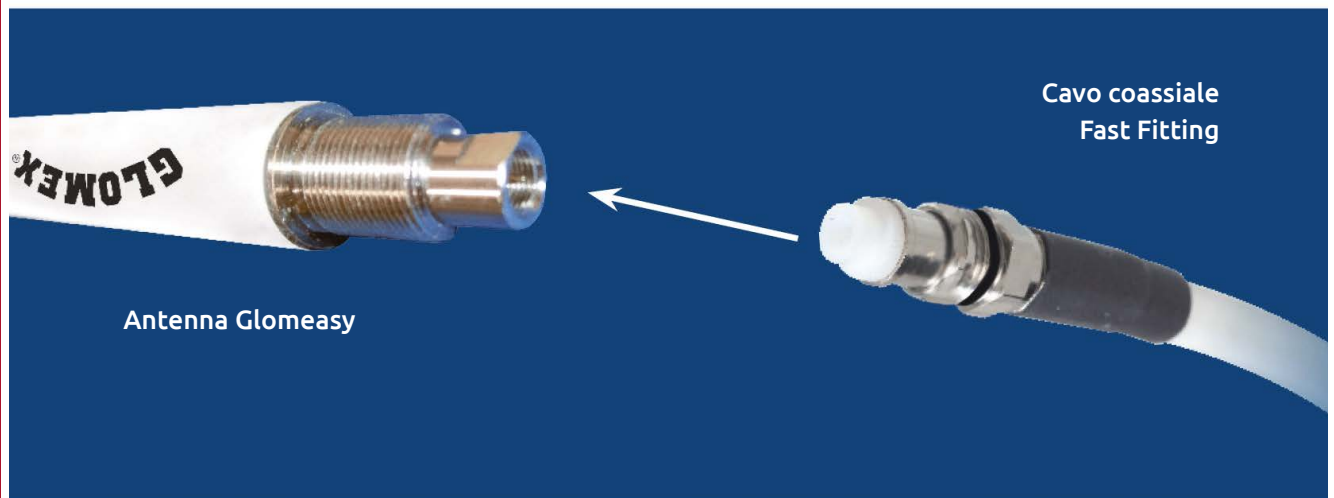

Waterproof Connection

The Glomeasy fast fitting connection is completely waterproof, so it ensures the

best possible connection and performance from the antenna to the radio.

GLOMEASY

Glomeasy line concept

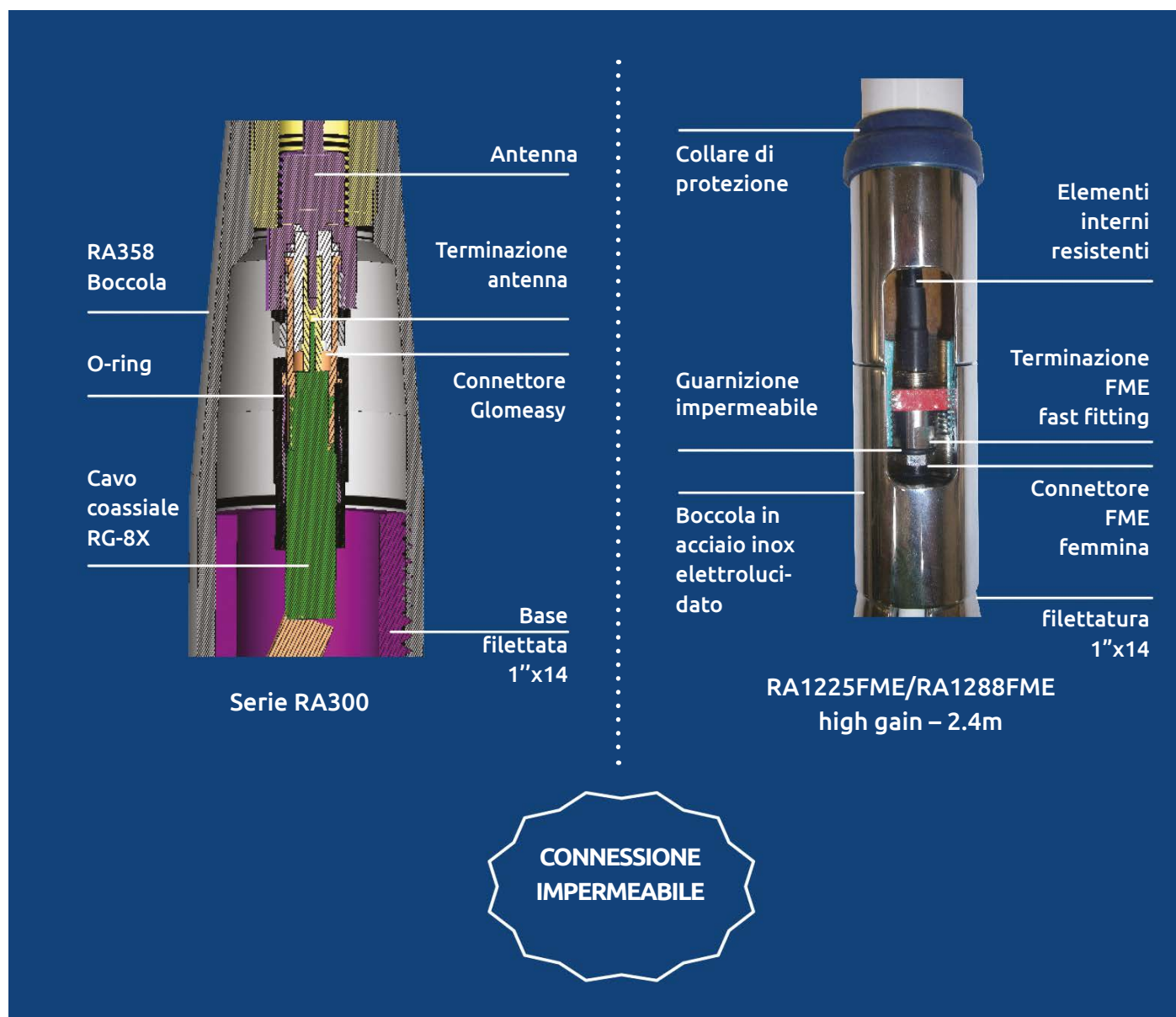

Flexibility and Easy Customization

Glomeasy is a range of single components that can be assembled together to create

a completely customizable solution for any application. Unlike other fast fitting systems, they do not require a specific mount to be used.



RA304

250 mm (10") white 3db small deck and regatta vhf fast fitting glomeasy antenna

Category: VHF

Subcategory: 250mm (10")

Code: RA304, RA304/BK



Glomex wants to make life easier for boat owners by offering a new very compact, rugged, high performance, adaptable to every need and fast fitting VHF antenna. The new antenna, made with the best raw materials, is composed of a fibreglass tube, resistant to stress and treated with anti-yellowing material, which protects the internal brass elements.

- ▶ Long 250mm (10"), with a gain of 3dB, the antenna is both for masthead installation in order to have the best transmission performance, and for the installation on motor boats thanks to various optional supports.
- ▶ On the bottom, the antenna has a 5/8"x24 threaded ferrule that can be matched with optional brackets and mounts.
- ▶ Moreover, the antenna can be provided with the Glomeasy high quality and low loss coaxial cable RG8X offered in various lengths and already pre-installed at both terminations with a special professional and miniaturized FME connector.

All these features allow boat owners to have a great freedom in the implementation of the VHF system and to have an extremely easy and fast installation, thanks to the FME-UHF adapter and various optional supports.

FREQUENCY RANGE	156/162 MHz
GAIN AVERAGE	3dB
IMPEDANCE	50 ohms
POLARIZATION	Vertical
SWR	≤ 1,3 at 156,8 MHz
MAX INPUT POWER	100 W
DC GROUND	Yes
ANTENNA LENGHT	250mm (10")
ANTENNA WEIGHT	150g
TERMINATION	FME
<i>More info on www.glomex.it</i>	



- ▶ Glomeasy Fast Fitting System
- ▶ No Soldering / No Cable Cutting

Glomex veut simplifier la vie aux plaisanciers en leur offrant une antenne VHF très compacte, robuste, performante, facilement adaptable pour chaque exigence et très rapide à installer. La nouvelle antenne, réalisée avec les meilleures matières premières, se compose d'une canne en fibre de verre, résistante aux contraintes, traitée avec un matériel anti-jaunissement, qui protège les éléments internes en laiton.

- ▶ Longue 250mm avec un gain de 3dB, l'antenne est indiquée pour l'installation en tête de mât du bateau afin d'avoir la meilleure performance de réception et de transmission, et aussi, grâce aux diverses options de supports, peut être installée également sur des bateaux à moteur.
- ▶ Sur l'extrémité inférieure, l'antenne dispose d'une virole fileté 5/8"x24 à laquelle on peut brancher des équerres et supports pour une installation extrêmement facile et rapide et le nouveau câble coaxial RG8X Glomeasy, de haute qualité, à faible perte et de différentes longueurs avec un connecteur spécial FME, professionnel et miniaturisé déjà inséré dans les deux extrémités.

Toutes ces caractéristiques permettent à l'antenne d'être extrêmement flexible, ce qui permet au plaisancier, une grande liberté dans la composition du système VHF et d'une installation extrêmement facile et rapide avec les différents supports en option.

Glomex vuole semplificare la vita dei diportisti offrendo loro un'antenna VHF molto compatta, robusta, performante, facilmente adattabile ad ogni esigenza e estremamente veloce da installare. La nuova antenna, realizzata con le migliori materie prime, è composta da una canna in fibra di vetro, resistente alle sollecitazioni e trattata con materiali anti-ingiallimento, che protegge gli elementi interni in ottone.

- ▶ Lunga 250mm, con un guadagno di 3dB, l'antenna è indicata sia per l'installazione sul ponte e in testa d'albero al fine di avere le migliori performance di ricezione e trasmissione.
- ▶ All'estremità inferiore l'antenna ha una boccola filettata 5/8"x24 su cui è possibile installare in maniera estremamente facile e rapida il nuovo cavo coassiale RG8X Glomeasy di altissima qualità e a bassa perdita offerto in varie lunghezze e già pre-installato in entrambe le estremità con lo speciale connettore FME, professionale e miniaturizzato.

Tutte queste caratteristiche permettono all'antenna di essere estremamente flessibile, consentendo al diportista una grande libertà nella composizione dell'impianto VHF ed un'installazione estremamente facile e rapida, grazie anche all'adattatore FME-UHF e ai vari supporti opzionali.

OPTIONAL ACCESSORIES



▲ RA369 Deck flange with nut and washer - chrome plated.



▲ RA135FME 4 Way ratched mount in reinforced nylon, knob locking, thread 5/8"x24



▲ RA107SSFME 4 Way ratched mount in stainless steel, locking by clamp, with cable slot, 1"x14 standard thread

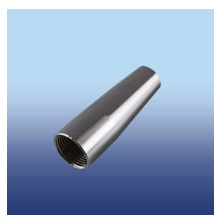

▲ RA358 Adaptor ferrule 5/8"x24 to 1"x14



▲ RA106BRACKINOX Electropolished stainless steel masthead bracket

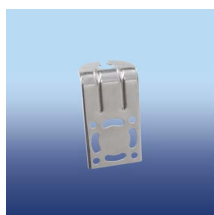

▲ RA106BRACKINOX-L Electropolished stainless steel L masthead bracket

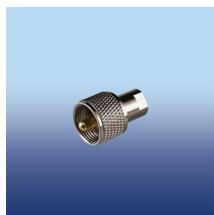

▲ RA352 FME male to PL259 male adaptor

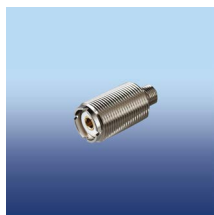

▲ RA351 FME Female to SO239 Adaptor



▲ RA350/3FME 3m (10') RG-8X low loss coaxial cable with pre-wired FME connectors



▲ RA350/6FME 6m (20') RG-8X low loss coaxial cable with pre-wired FME connectors



▲ RA350/12FME 12m (39') RG-8X low loss coaxial cable with pre-wired FME connectors



▲ RA350/18FME 18m (59') RG-8X low loss coaxial cable with pre-wired FME connectors



▲ RA350/25FME 25m (82') RG-8X low loss coaxial cable with pre-wired FME connectors



▲ RA350/30FME 30m (100') RG-8X low loss coaxial cable with pre-wired FME connectors

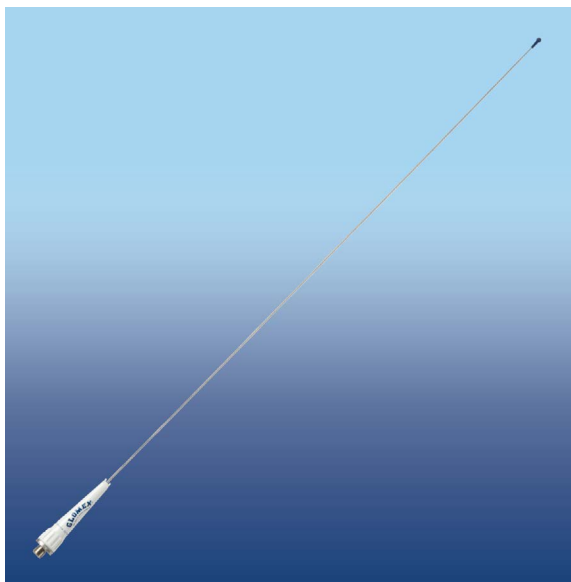

RA106SLSFME

900 mm (35") VHF 3dB fast fitting Glomeasy antenna with stainless steel whip

Category: VHF

Subcategory: 900mm (35")

Code: RA106SLSFME



Glomeasy line antennas are the new VHF antennas, specifically developed to make life easier for boat owners and, at the same time, to ensure the thirty-year security of Glomex antennas thanks to the attention and care in the selection of materials and in the technological research.

RA106SLSFME has a stainless steel whip, is high-performance, rugged and ideal for all types of small and medium size sailing and motor yachts. The innovative element of these antennas is their ability to offer a great flexibility to the boat owners in the implementation of its VHF system.

With Glomeasy VHF antennas, Glomex wants to meet the multiple needs of antenna installation providing an antenna that can be matched with different mounts and brackets and a high quality and low loss coaxial cable, offered in various lengths and already plugged at both ends with a special professional and miniaturized FME connector.

All this allows boat owners to have a great freedom in the implementation of the VHF system and to have an extremely easy and fast installation, thanks to the FME-SO239 adapter (code RA351) and various optional supports.

FREQUENCY RANGE	156/162 MHz
GAIN AVERAGE	3dB
IMPEDANCE	50 ohms
POLARIZATION	Vertical
SWR	≤ 1,3 at 156,8 MHz
MAX INPUT POWER	100 W
DC GROUND	Yes
ANTENNA LENGHT	900mm/35"
ANTENNA WEIGHT	180g/6,35oz
TERMINATION	FME
<i>More info on www.glomex.it</i>	



- ▶ Glomeasy Fast Fitting System
- ▶ No Soldering / No Cable Cutting

Les antennes VHF Glomeasy simplifient la vie des plaisanciers et, en même temps assurent la 30 ans sécurité des antennes Glomex grâce à l'attention en choisir les meilleurs matériaux de construction et à la fiabilité de fonctionnement.

RA106SLSFME a le style en acier inoxydable et est une antenne performante, robuste et idéale pour tous les types d'embarcation à voile et bateaux à moteur de petite et moyenne dimension. L'élément novateur de cette antenne est sa capacité à offrir une grande souplesse aux plaisanciers dans la réalisation du système VHF.

Avec les antennes Glomeasy, Glomex en fait veut répondre aux multiples exigences que ce soit en la fourniture comme sur l'installation de l'antenne à laquelle vous pouvez connecter différents supports et un câble coaxial de haute qualité, à faible perte et de différentes longueurs avec un connecteur spécial FME, professionnel et miniaturisé déjà inséré dans les deux extrémités.

Ce qui permet une grande liberté au plaisancier dans la composition du système VHF et une installation extrêmement simple et rapide, grâce à l'adaptateur FME-SO239 (code RA351) et aux différentes supports en option.

Le nuove antenne VHF della gamma Glomeasy semplificano la vita dei diportisti assicurando, allo stesso tempo, la trentennale sicurezza delle antenne Glomex nella scelta dei migliori materiali costruttivi e nell'affidabilità di funzionamento.

L'antenna RA106SLSFME è dotata di uno stilo in acciaio inox Aisi 316 e si distingue per essere performante, robusta ed ideale per tutti i tipi d'imbarcazione a vela e a motore, dalle piccole e medie dimensioni. L'elemento innovativo delle antenne Glomeasy è la loro capacità di offrire una grande flessibilità al diportista nella realizzazione del proprio impianto VHF.

Glomex, infatti, vuole venire incontro alle molteplici esigenze di installazione offrendo un'antenna a cui è possibile associare differenti supporti ed un cavo coassiale di altissima qualità e a bassa perdita offerto in varie lunghezze e già cablato in entrambe le estremità con lo speciale connettore FME, professionale e miniaturizzato.

Tutto questo consente al diportista una grande libertà nella composizione dell'impianto VHF ed un'installazione estremamente facile e rapida, grazie anche all'adattatore FME-SO239 (RA351) e ai vari supporti opzionali.

OPTIONAL ACCESSORIES



▲ RA135FME 4 Way ratched mout in reinforced nylon, knob locking, thread 5/8"x24



▲ RA107SSFME 4 Way ratched mout in stainless steel, locking by clamp, with cable slot, 1"x14 standard thread

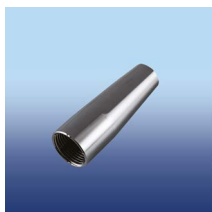

▲ RA358 Adaptor ferrule 5/8"x24 to 1"x14



▲ RA106BRACKINOX Electropolished stainless steel masthead bracket

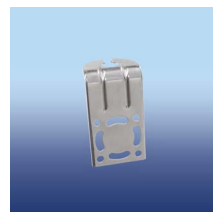

▲ RA106BRACKINOX-L Electropolished stainless steel L masthead bracket



▲ RA352 FME male to PL259 male adaptor



▲ RA351 FME Female to SO239 Adaptor



▲ RA350/3FME 3m (10') RG-8X low loss coaxial cable with pre-wired FME connectors



▲ RA350/6FME 6m (20') RG-8X low loss coaxial cable with pre-wired FME connectors



▲ RA350/12FME 12m (39') RG-8X low loss coaxial cable with pre-wired FME connectors



▲ RA350/18FME 18m (59') RG-8X low loss coaxial cable with pre-wired FME connectors



▲ RA350/25FME 25m (82') RG-8X low loss coaxial cable with pre-wired FME connectors



▲ RA350/30FME 30m (100') RG-8X low loss coaxial cable with pre-wired FME connectors

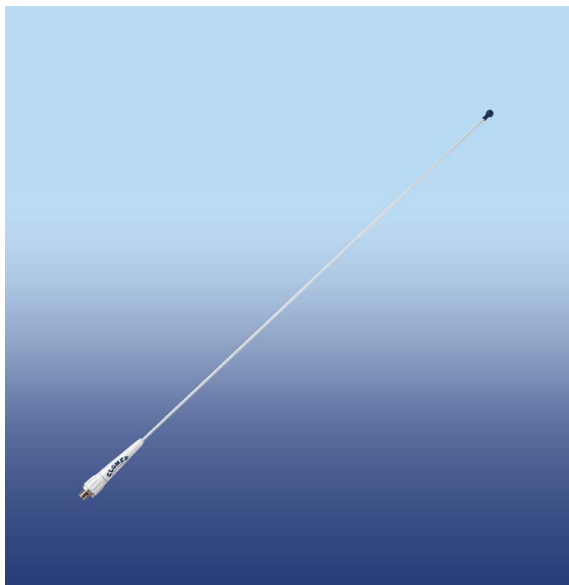

RA106GRPFME

900 mm (35") VHF 3dB fast fitting Glomeasy antenna with fiberglass whip

Category: VHF

Subcategory: 900mm (35")

Code: RA106GRPFME



Glomeasy line antennas are the new VHF antennas, specifically developed to make life easier for boat owners and, at the same time, to ensure the thirty-year security of Glomex antennas thanks to the attention and care in the selection of materials and in the technological research.

RA106GRPFME has a fiberglass whip, is high-performance, rugged and ideal for all types of small and medium size sailing and motor yachts. The innovative element of these antennas is their ability to offer a great flexibility to the boat owners in the implementation of its VHF system.

With Glomeasy VHF antennas, Glomex wants to meet the multiple needs of antenna installation providing an antenna that can be matched with different mounts and brackets and a high quality and low loss coaxial cable, offered in various lengths and already plugged at both ends with a special professional and miniaturized FME connector.

All this allows boat owners to have a great freedom in the implementation of the VHF system and to have an extremely easy and fast installation, thanks to the FME-SO239 adapter (code RA351) and various optional supports.

FREQUENCY RANGE	156/162 MHz
GAIN AVERAGE	3dB
IMPEDANCE	50 ohms
POLARIZATION	Vertical
SWR	≤ 1,3 at 156,8 MHz
MAX INPUT POWER	100 W
DC GROUND	Yes
ANTENNA LENGHT	900mm/35"
ANTENNA WEIGHT	180g/6,35oz
TERMINATION	FME
<i>More info on www.glomex.it</i>	



- ▶ Glomeasy Fast Fitting System
- ▶ No Soldering / No Cable Cutting

Les antennes VHF Glomeasy simplifient la vie des plaisanciers et, en même temps assurent la 30 ans sécurité des antennes Glomex grâce à l'attention en choisir les meilleurs matériaux de construction et à la fiabilité de fonctionnement.

RA106GRPFME a le style en fibre de verre et est une antenne performante, robuste et idéale pour tous les types d'embarcation à voile et bateaux à moteur de petite et moyenne dimension. L'élément novateur de cette antenne est sa capacité à offrir une grande souplesse aux plaisanciers dans la réalisation du système VHF.

Avec les antennes Glomeasy, Glomex en fait veut répondre aux multiples exigences que ce soit en la fourniture comme sur l'installation de l'antenne à laquelle vous pouvez connecter différents supports et un câble coaxial de haute qualité, à faible perte et de différentes longueurs avec un connecteur spécial FME, professionnel et miniaturisé déjà inséré dans les deux extrémités.

Ce qui permet une grande liberté au plaisancier dans la composition du système VHF et une installation extrêmement simple et rapide, grâce à l'adaptateur FME-SO239 (code RA351) et aux différentes supports en option.

Le nuove antenne VHF della gamma Glomeasy semplificano la vita dei diportisti assicurando, allo stesso tempo, la trentennale sicurezza delle antenne Glomex nella scelta dei migliori materiali costruttivi e nell'affidabilità di funzionamento.

L'antenna RA106GRPFME è dotata di uno stilo in fibra di vetro e si distingue per essere performante, robusta ed ideale per tutti i tipi d'imbarcazione a vela e a motore, dalle piccole e medie dimensioni. L'elemento innovativo delle antenne Glomeasy è la loro capacità di offrire una grande flessibilità al diportista nella realizzazione del proprio impianto VHF.

Glomex, infatti, vuole venire incontro alle molteplici esigenze di installazione offrendo un'antenna a cui è possibile associare differenti supporti ed un cavo coassiale di altissima qualità e a bassa perdita offerto in varie lunghezze e già cablato in entrambe le estremità con lo speciale connettore FME, professionale e miniaturizzato.

Tutto questo consente al diportista una grande libertà nella composizione dell'impianto VHF ed un'installazione estremamente facile e rapida, grazie anche all'adattatore FME-SO239 (RA351) e ai vari supporti opzionali.

OPTIONAL ACCESSORIES



▲ RA135FME 4 Way ratched mout in reinforced nylon, knob locking, thread 5/8"x24



▲ RA107SSFME 4 Way ratched mout in stainless steel, locking by clamp, with cable slot, 1"x14 standard thread

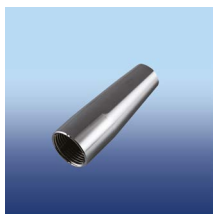

▲ RA358 Adaptor ferrule 5/8"x24 to 1"x14



▲ RA106BRACKINOX Electropolished stainless steel masthead bracket



▲ RA106BRACKINOX-L Electropolished stainless steel L masthead bracket

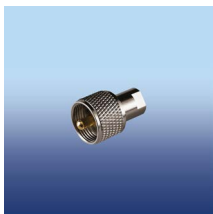

▲ RA352 FME male to PL259 male adaptor

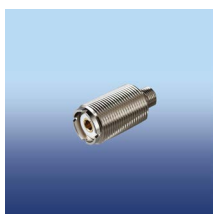

▲ RA351 FME Female to SO239 Adaptor



▲ RA350/3FME 3m (10') RG-8X low loss coaxial cable with pre-wired FME connectors



▲ RA350/6FME 6m (20') RG-8X low loss coaxial cable with pre-wired FME connectors



▲ RA350/12FME 12m (39') RG-8X low loss coaxial cable with pre-wired FME connectors



▲ RA350/18FME 18m (59') RG-8X low loss coaxial cable with pre-wired FME connectors



▲ RA350/25FME 25m (82') RG-8X low loss coaxial cable with pre-wired FME connectors



▲ RA350/30FME 30m (100') RG-8X low loss coaxial cable with pre-wired FME connectors



RA300

1,2 m (4') VHF 3dB Fast fitting Glomeasy antenna

Category: VHF

Subcategory: 1,2m (4')

Code: RA300, RA300/BK



Glomex wants to make life easier for boat owners by offering a new universal, rugged, high performance, adaptable to every need and fast fitting VHF antenna RA300. The new antenna, made with the best raw materials, is composed of a fibreglass tube, resistant to stress and treated with anti-yellowing material, which protects the internal brass elements.

Long 1.2 m (4'), with a gain of 3dB, the antenna is both for masthead installation in order to have the best transmission performance, and for the installation on motor boats thanks to various optional supports.

On the bottom, the antenna has a 5/8"x24 threaded ferrule that can be matched with optional brackets and mounts. Moreover, the antenna can be provided with the new Glomex high quality and low loss coaxial cable RG8X offered in various lengths and already pre-installed at both terminations with a special professional and miniaturized FME connector. If, however, it is necessary to have a longer antenna, you can use the new 1,2m (4') rugged extension RA303, made with the same construction materials of the VHF antenna to get outstanding aesthetics.

This extension is easily mountable on the bottom of the antenna and is equipped with an internal, integrated 1"x14 ferrule to easily install it on any Glomex mounts. All these features allow boat owners to have a great freedom in the implementation of the VHF system and to have an extremely easy and fast installation, thanks to the FME-UHF adapter and various optional supports.

FREQUENCY RANGE	156/162 MHz
GAIN AVERAGE	3dB
IMPEDANCE	50 ohms
POLARIZATION	Vertical
SWR	≤ 1,3 at 156,8 MHz
MAX INPUT POWER	100 W
DC GROUND	Yes
ANTENNA LENGTH	1,2m'
ANTENNA WEIGHT	325g/11,46oz
TERMINATION	FME
<i>More info on www.glomex.it</i>	



- ▶ **Glomeasy Fast Fitting System**
- ▶ **No Soldering / No Cable Cutting**

Glomex veut simplifier la vie aux plaisanciers en leur offrant une antenne universelle VHF robuste, performante, facilement adaptable pour chaque exigence et très rapide à installer. La nouvelle antenne, réalisée avec les meilleures matières premières, se compose d'une canne en fibre de verre, résistante aux contraintes, traitée avec un matériel anti-jaunissement, qui protège les éléments internes en laiton.

Longue 1,2m avec un gain de 3dB, l'antenne est indiquée pour l'installation en tête de mât du bateaux afin d'avoir la meilleure performance de réception et de transmission, et aussi, grâce aux diverses options de supports, peut être installée également sur des bateaux à moteur. Sur l'extrémité inférieure, l'antenne dispose d'une virole filetée 5/8"x24 à laquelle on peut brancher des équerres et supports pour une installation extrêmement facile et rapide et le nouveau câble coaxial RG8X de Glomex, de haute qualité, à faible perte et de différentes longueurs avec un connecteur spécial FME, professionnel et miniaturisé déjà inséré dans les deux extrémités.

Si, toutes fois, il est nécessaire d'avoir une antenne plus longue, vous pouvez utiliser la nouvelle extension construite avec les mêmes matériaux robustes sous-ensembles de l'antenne VHF pour obtenir une esthétique exceptionnelle. Cette rallonge est facilement montable sur l'extrémité inférieure de l'antenne et est équipée d'une virole interne intégré 1"x14 pour faciliter son fixage sur toutes les supports Glomex.

Toutes ces caractéristiques permettent à l'antenne d'être extrêmement flexible, ce qui permet au plaisancier, une grande liberté dans la composition du système VHF et d'une installation extrêmement facile et rapide avec les différentes supports en option.

Glomex vuole semplificare la vita dei diportisti offrendo loro un'antenna universale VHF robusta, performante, facilmente adattabile ad ogni esigenza ed estremamente veloce da installare. La nuova antenna, realizzata con le migliori materie prime, è composta da una canna in fibra di vetro, resistente alle sollecitazioni e trattata con materiali anti-ingiallimento, che protegge gli elementi interni in ottone.

Lunga 1,2m, con un guadagno di 3dB, l'antenna è indicata sia per l'installazione in testa d'albero al fine di avere le migliori performance di ricezione e trasmissione sia, grazie a varie basi opzionali, per l'installazione su imbarcazioni a motore. All'estremità inferiore l'antenna ha una boccola filettata 5/8"x24 su cui è possibile installare in maniera estremamente facile e rapida il nuovo cavo coassiale RG8X di Glomex di altissima qualità e a bassa perdita offerto in varie lunghezze e già pre-installato in entrambe le estremità con lo speciale connettore FME, professionale e miniaturizzato.

Qualora, invece, fosse necessario avere un'antenna più lunga, è possibile utilizzare la nuova robusta prolunga di 1,2m, realizzata con gli stessi materiali costruttivi dell'antenna VHF per ottenere un'estetica eccezionale. Tale prolunga è facilmente montabile sull'estremità inferiore dell'antenna ed è dotata di una boccola interna integrata 1"x14 per facilitare il suo fissaggio su qualsiasi base Glomex.

Tutte queste caratteristiche permettono all'antenna di essere estremamente flessibile, consentendo al diportista una grande libertà nella composizione dell'impianto VHF ed un'installazione estremamente facile e rapida, grazie anche all'adattatore FME-UHF e ai vari supporti opzionali.

OPTIONAL ACCESSORIES



▲ RA135FME 4 Way ratched mout in reinforced nylon, knob locking, thread 5/8"x24



▲ RA107SSFME 4 Way ratched mount in stainless steel, locking by clamp, with cable slot, 1"x14 standard thread

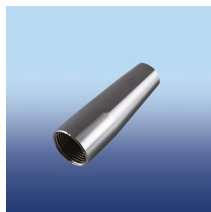

▲ RA358 Adaptor ferrule 5/8"x24 to 1"x14



▲ RA106BRACKINOX Electropolished stainless steel masthead bracket



▲ RA106BRACKINOX-L Electropolished stainless steel L masthead bracket



▲ RA352 FME male to PL259 male adaptor



▲ RA351 FME Female to SO239 Adaptor



▲ RA350/3FME 3m (10') RG-8X low loss coaxial cable with pre-wired FME connectors



▲ RA350/6FME 6m (20') RG-8X low loss coaxial cable with pre-wired FME connectors



▲ RA350/12FME 12m (39') RG-8X low loss coaxial cable with pre-wired FME connectors



▲ RA350/18FME 18m (59') RG-8X low loss coaxial cable with pre-wired FME connectors



▲ RA350/25FME 25m (82') RG-8X low loss coaxial cable with pre-wired FME connectors



▲ RA350/30FME 30m (100') RG-8X low loss coaxial cable with pre-wired FME connectors



▲ RA303 - 1,2m (4') fiberglass extension



RA303

1,2 m (4') fast fitting Glomeasy extension

Category: Accessories

Code: RA303



Glomeasy line accessories are specifically developed to make life easier for boat owners and, at the same time, to ensure the thirty-year security of Glomex antennas thanks to the attention and care in the selection of materials and in the technological research.

RA303 is the extension for the universal VHF/FM/DAB/AIS antenna RA300 and is used for vertical elevation of the antenna in order to clear the reception/transmission field.

This 1,2m (4') rugged fiberglass extension is made with the same construction materials of the universal antenna RA300 to get outstanding aesthetics.

This extension is easily mountable on the bottom of the antenna and is equipped with an internal, integrated 1"x14 ferrule to easily install it on any Glomex mounts.

Les accessoires Glomeasy simplifient la vie des plaisanciers et, en même temps assurent la 30 ans sécurité des antennes Glomex grâce à l'attention en choisir les meilleurs matériaux de construction et à la fiabilité de fonctionnement.

RA303 est une rallonge pour l'antenne universelle VHF RA300 et elle est utilisées pour élever verticalement l'antenne et rendre la zone de réception/transmission libre.

RA303 est en fibre de verre et est construite avec les même matériaux robustes sous-ensembles de l'antenne universelle VHF RA300 pour obtenir une esthétique exceptionnelle.

Cette rallonge est facilement montable sur l'extrémité inférieure de l'antenne et est équipée d'un virole interne intégré 1"x14 pour faciliter son fixage sur toutes les supports Glomex.

OPTIONAL ACCESSORIES

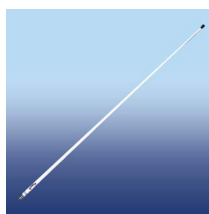

▲ RA300 1,2m (4') VHF Glomeasy fast fitting antenna

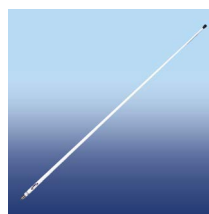

▲ RA300FM 1,2m (4') FM Glomeasy fast fitting antenna

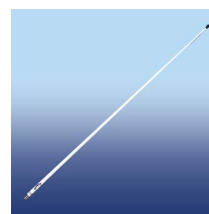

▲ RA300AIS 1,2m (4') AIS Glomeasy fast fitting antenna

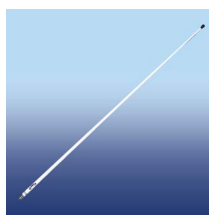

▲ RA300DAB 1,2m (4') DAB Glomeasy fast fitting antenna



▲ 4 Way ratched mount in stainless steel, locking by clamp, with cable slot, 1"x14 standard thread

I nuovi accessori della gamma Glomeasy semplificano la vita dei deportisti assicurando, allo stesso tempo, la trentennale sicurezza delle antenne Glomex nella scelta dei migliori materiali costruttivi e nell'affidabilità di funzionamento.

RA301 è la prolunga per l'antenna universale VHF/FM/DAB/AIS RA300, è utilizzata per elevare verticalmente l'antenna, liberando il campo di ricezione/trasmissione.

Tale prolunga in fibra di vetro, lunga 1,2 m, si distingue per essere estremamente robusta e realizzata con gli stessi materiali costruttivi dell'antenna RA300 per ottenere un'estetica eccezionale.

Tale prolunga è facilmente montabile sull'estremità inferiore dell'antenna ed è dotata di una boccola interna integrata 1"x14 per facilitare il suo fissaggio su qualsiasi base Glomex.



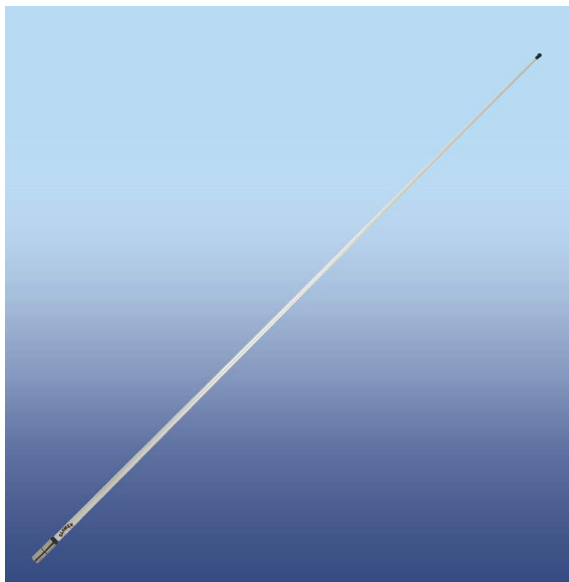

RA1225FME

2,4 m (8') VHF 6dB High Performance fast fitting Glomeasy antenna with special stainless steel ferrule

Category: High Performance VHF

Subcategory: 2,4m (8')

Code: RA1225FME



RA1225FME is the new 2.40 m (8') collinear VHF antenna with FME termination, designed to assure excellent performance in terms of quality, operation and design. It has a special stainless steel ferrule for a very easy installation.

Compared to the traditional antennas, whilst similar in shape, this antenna deeply differentiates itself due to two very important aspects:

- ▶ it has the FME termination for a very quick and more comfortable installation. Thanks to the FME termination, you will use the Glomex FME coaxial cables (code RA350), in different lengths, with a pre-installed professional, high quality and rugged FME connector that can be fitted on the antenna in a few seconds without soldering or cutting the cable;
- ▶ the inside finish and the rod features. Made of spiral copper wires inserted in brass tubes, this antenna assures a long-range communication and best radio performance. The tube is made of fibreglass with polished polyurethane finish and resistant to UV-rays and is reinforced by a double-layer (1,2 mm/0,05'.)

Moreover, RA1225FME is a vertical polarization antenna minimizing the effect of reflection on flat surfaces, always ensuring the best possible performance. For its installation, RA1225FME needs a mount with cable slot: RA107SSFME.

FREQUENCY RANGE:	156 / 162 MHz
GAIN AVERAGE:	6 dB
IMPEDANCE:	50 ohms
SWR:	≤ 1.3 at 156.8 MHz
MAX INPUT POWER:	100 W
POLARIZATION:	Vertical
DC GROUND:	Yes
ANTENNA LENGTH:	2.4m / 4'
ANTENNA WEIGHT:	750g / 26.3 oz
TERMINATION:	FME
<i>More info on www.glomex.it</i>	

Special Glomeasy Dual Ferrule for a very east installation



RA1225FME est la nouvelle antenne colinéaire VHF haute 2,40 m avec la terminaison FME, conçue pour garantir d'excellentes performances en termes de qualité, de fonctionnalité et de design.

Par rapport aux antennes traditionnelles, dont elle ne conserve que l'apparence, cette antenne se différencie par deux aspects très importants :

- ▶ elle est dotée de la terminaison FME pour une facile installation. Merci à la terminaison FME, vous pouvez utiliser les câbles coaxiaux de Glomex (code RA350), en différentes longueurs, avec un connecteur pré-installé, professionnel, de haute qualité et robuste qui peut être monté sur l'antenne en quelques secondes sans soudure ou couper le câble ;
- ▶ ses finitions intérieures et par les caractéristiques de son foudet. Fabriquée en fils de cuivre en spirale insérés dans des tubes en laiton, cette antenne assure une communication de longue portée et une très bonne réception radio.

Le tube en fibres de verre avec finition en polyuréthane brillant résistant aux rayons UV, est renforcé par un tube à doublé épaisseur (1,2 mm/0,05") qui en renforce la structure. RA1225FME est une antenne à polarisation verticale qui minimise les effets de réflexion sur des surfaces planes, en garantissant toujours le meilleur rendement possible

RA1225FME è la nuova antenna collineare alta 2.40 m con la terminazione FME, progettata per garantire performances eccellenti in termini di qualità, funzionalità e design. Dotata di una speciale boccola in acciaio inox per una facile installazione.

Rispetto alle antenne tradizionali, delle quali mantiene solo l'apparenza, si differenzia profondamente per due caratteristiche molto importanti:

- ▶ è dotata della terminazione FME per una installazione molto veloce e facile. Grazie alla terminazione FME, potrete utilizzare i cavi coassiali Glomex FME (codice RA350), in diverse lunghezze, con un connettore pre-installato, professionale, di alta qualità e robusto che può essere montato nell'antenna in un pochi secondi senza saldatura o tagliare il cavo;
- ▶ le finiture interne e le caratteristiche dello stilo. Costruita con fili di rame spiralato inseriti in tubi d'ottone, assicura una comunicazione a lungo raggio e prestazioni ottimali delle radio. Il tubo, realizzato in fibra di vetro con finiture in poliuretano lucido resistente ai raggi U.V., presenta un tubo a doppio spessore (1,2 mm/0,05") che ne rinforza la struttura.

Inoltre, RA1225FME è un'antenna a polarizzazione verticale che minimizza gli effetti di riflessione sulle superfici piane garantendo sempre le migliori prestazioni possibili. Per la sua installazione, occorre utilizzare una base con passacavo: RA107SSFME.

OPTIONAL ACCESSORIES

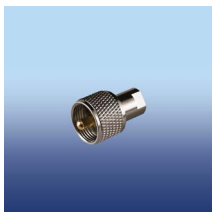

▲ RA352 FME male to PL259 male adaptor



▲ RA107SSFME 4 Way ratched mount in stainless steel, locking by clamp, with cable slot, 1"x14 standard thread



▲ RA351 FME Female to SO239 Adaptor



▲ RA350/3FME 3m (10') RG-8X low loss coaxial cable with pre-wired FME connectors



▲ RA350/6FME 6m (20') RG-8X low loss coaxial cable with pre-wired FME connectors



▲ RA350/12FME 12m (39') RG-8X low loss coaxial cable with pre-wired FME connectors



▲ RA350/18FME 18m (59') RG-8X low loss coaxial cable with pre-wired FME connectors



▲ RA350/25FME 25m (82') RG-8X low loss coaxial cable with pre-wired FME connectors



▲ RA350/30FME 30m (100') RG-8X low loss coaxial cable with pre-wired FME connectors

NEW



RA1206FME

2,4 m (8') VHF 6dB Fast fitting Glomeasy antenna with special stainless steel ferrule

Category: VHF

Subcategory: 2,4m (8')

Code: RA1206FME



RA1206FME is the new 2.40 m (8'), 6 dB, VHF, brass elements J-Pole antenna with FME termination, designed to assure excellent performance in terms of quality, operation and design. It has a special stainless steel dual ferrule to avoid cable twisting for a very easy installation. Compared to the traditional antennas, whilst similar in shape, this antenna deeply differentiates itself due to two very important aspects:

- ▶ it has the FME termination for a very quick and more comfortable installation. Thanks to the FME termination, you will use the Glomex FME coaxial cables (code RA350), in different lengths, with a pre-installed professional, high quality and rugged FME connector that can be fitted on the antenna in a few seconds without soldering or cutting the cable;
- ▶ the inside finish and the rod features. Made of spiral copper wires inserted in brass tubes, this antenna assures long-range communication and the best radio performance. The tube is made of fibreglass with a polished polyurethane finish and resistant to UV-rays and is reinforced by a double-layer (1,2 mm/0,05'.)

Why choose Glomex RA1206FME over competitors' fast fitting systems?

Glomeasy line antennas are the only fast fitting system in the market with waterproof connection that is not made between the mount and the antenna, but between the cable and the antenna. So it's completely independent and waterproof. This ensures an extremely longer-lasting and safer communication system than competing antennas.

Moreover, RA1206FME is a vertical polarization antenna minimizing the effect of reflection on flat surfaces, always ensuring the best possible performance. For its installation, RA1206FME needs a mount with a cable slot: RA107SSFME.

FREQUENCY RANGE:	156 / 162 MHz
GAIN AVERAGE:	6 dB
IMPEDANCE:	50 ohms
SWR:	≤ 1.3 at 156.8 MHz
MAX INPUT POWER:	100 W
POLARIZATION:	Vertical
DC GROUND:	Yes
ANTENNA LENGTH:	2.4m / 4'
ANTENNA WEIGHT:	750g / 26.3 oz
TERMINATION:	FME
<i>More info on www.glomex.it</i>	

Special Glomeasy Dual Ferrule for a very easy installation



YouTube

RA1206FME est la nouvelle antenne j-Pole VHF haute 2,40 m avec la terminaison FME, conçue pour garantir d'excellentes performances en termes de qualité, de fonctionnalité et de design. Par rapport aux antennes traditionnelles, dont elle ne conserve que l'apparence, cette antenne se différencie par deux aspects très importants :

- ▶ elle est dotée de la terminaison FME pour une facile installation. Merci à la terminaison FME, vous pouvez utiliser les câbles coaxiaux de Glomex (code RA350), en différentes longueurs, avec un connecteur pré-installé, professionnel, de haute qualité et robuste qui peut être monté sur l'antenne en quelques secondes sans soudure ou couper le câble ;
- ▶ ses finitions intérieures et par les caractéristiques de son fouet. Fabriquée en fils de cuivre en spirale insérés dans des tubes en laiton, cette antenne assure une communication de longue portée et une très bonne réception radio. Le tube en fibres de verre avec finition en polyuréthane brillant résistant aux rayons UV, est renforcé par un tube à double épaisseur (1,2 mm/0,05') qui renforce la structure. RA1206FME est une antenne à polarisation verticale qui minimise les effets de réflexion sur des surfaces planes, en garantissant toujours le meilleur rendement possible

Pourquoi choisir Glomex RA1206FME par rapport aux systèmes de montage rapide des concurrents ?

Les antennes Glomeasy sont les seules antennes avec système fast-fitting sur le marché à avoir une connexion étanche. La connexion n'est pas entre la base et l'antenne, mais entre le câble et l'antenne. Cela garantit une connexion entièrement indépendante et étanche à l'eau. Le système de communication Glomeasy est donc plus sûr et durable que les systèmes concurrents.

De plus, le RA1206FME est une antenne à polarisation verticale qui minimise les effets de réflexion sur les surfaces planes en garantissant toujours les meilleures performances possibles. Pour son installation, il faut utiliser une base avec passage de câble: RA107SSFME.

RA1206FME è la nuova antenna J-Pole alta 2.40 m con la terminazione FME, progettata per garantire performances eccellenti in termini di qualità, funzionalità e design. Dotata di una speciale boccola in acciaio inox per una facile installazione. Rispetto alle antenne tradizionali, delle quali mantiene solo l'apparenza, si differenzia profondamente per due caratteristiche molto importanti:

- ▶ è dotata della terminazione FME per una installazione molto veloce e facile. Grazie alla terminazione FME, potrete utilizzare i cavi coassiali Glomex FME (codice RA350), in diverse lunghezze, con un connettore pre-installato, professionale, di alta qualità e robusto che può essere montato nell'antenna in un pochi secondi senza saldatura o tagliare il cavo;
- ▶ le finiture interne e le caratteristiche dello stilo. Costruita con fili di rame spiralato inseriti in tubi d'ottone, assicura una comunicazione a lungo raggio e prestazioni ottimali delle radio. Il tubo, realizzato in fibra di vetro con finiture in poliuretano lucido resistente ai raggi U.V., presenta un tubo a doppio spessore (1,2 mm/0,05') che ne rinforza la struttura.

Perché scegliere Glomex RA1206FME rispetto ai sistemi di montaggio rapido dei concorrenti?

Le antenne Glomeasy sono le uniche antenne con sistema fast fitting presenti sul mercato ad avere la connessione impermeabile. La connessione non è tra la base e l'antenna, ma è tra il cavo e l'antenna. Ciò garantisce un connessione completamente indipendente e impermeabile all'acqua. Il sistema di comunicazione Glomeasy, pertanto, è più sicuro e duraturo nel tempo rispetto ai sistemi concorrenti.

Inoltre, RA1206FME è un'antenna a polarizzazione verticale che minimizza gli effetti di riflessione sulle superfici piane garantendo sempre le migliori prestazioni possibili. Per la sua installazione, occorre utilizzare una base con passacavo: RA107SSFME.

OPTIONAL ACCESSORIES



▲ RA107SSFME 4 Way ratched mount in stainless steel, locking by clamp, with cable slot, 1"x14 standard thread



▲ RA106BRACKINOX Electropolished stainless steel masthead bracket



▲ RA106BRACKINOX-L Electropolished stainless steel L masthead bracket

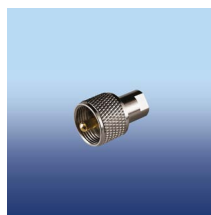

▲ RA352 FME male to PL259 male adaptor

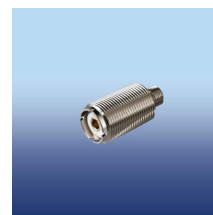

▲ RA351 FME Female to SO239 Adaptor



▲ RA350/6FME 6m (20') RG-8X low loss coaxial cable with pre-wired FME connectors



▲ RA350/18FME 18m (59') RG-8X low loss coaxial cable with pre-wired FME connectors



▲ RA350/30FME 30m (100') RG-8X low loss coaxial cable with pre-wired FME connectors



RA300FM

1,2 m (4') FM fast fitting Glomeasy antenna

Category: FM

Subcategory: 1,2m (4')

Code: RA300FM, RA300FM/BK



The FM is a common VHF transmission mode. FM bands are less prone to disturbances and interferences assuring a clear transmission and reception of signals. FM antennas are often used to listen to radio stations also during navigation. Glomex wants to make life easier for boat owners by offering a new universal, rugged, high performance and adaptable to every need FM antenna RA300FM. The new antenna, made with the best raw materials, is composed of a fibreglass tube, resistant to stress and treated with anti-yellowing material, which protects the internal brass elements. Long 1.2 m (4'), the antenna is both for masthead installation in order to have the best receiving performance, and for the installation on motor boats thanks to various optional supports. On the bottom, the antenna has a 5/8"x24 threaded ferrule that can be matched with optional brackets and mounts.

Moreover, the antenna can be provided with the new Glomex high quality and low loss coaxial cable RG62 offered in various lengths and already pre-installed at one side with a special professional and miniaturized FME connector to install it on the antenna and, on the other side, with a Motorola plug to easily assemble your FM system. If, however, it is necessary to have a longer antenna, you can use the new 1,2m (4') rugged extension RA301, made with the same construction materials of the FM antenna to get outstanding aesthetics. This extension is easily mountable on the bottom of the antenna and is equipped with an internal, integrated 1"x14 ferrule to easily install it on any Glomex mounts. All these features allow boat owners to have a great freedom in the implementation of the FM system and to have an extremely easy and fast installation, thanks to various optional supports.

FREQUENCY RANGE:	88 / 108 MHz
IMPEDANCE:	93 ohms
ANTENNA LENGTH:	1.2 / 4'
ANTENNA WEIGHT:	325g / 11.46 oz
TERMINATION:	FME
<i>More info on www.glomex.it</i>	



- ▶ Glomeasy Fast Fitting System
- ▶ No Soldering / No Cable Cutting

Le mode de transmission FM est utilisée pour la VHF. Les bandes FM ne sont pas gênées par les perturbations et les interférences, assurant une réception claires des signaux. Les antennes FM sont souvent employées pour écouter les stations radio même pendant la navigation. Glomex veut simplifier la vie aux plaisanciers en leurs offrant une antenne universelle FM robuste, performante et facilement adaptable pour chaque exigence. La nouvelle antenne, réalisée avec les meilleures matières premières, se compose d'une canne en fibre de verre, résistante aux contraintes, traitée avec un matériel anti-jaunissement, qui protège les éléments internes en laiton. Longue 1,2m, l'antenne est indiquée pour l'installation en tête de mât du bateaux afin d'avoir la meilleure performance de réception, et aussi, grâce aux diverses options de supports, peut être installée également sur des bateaux à moteur.

Sur l'extrémité inférieur, l'antenne dispose d'une virole fileté 5/8"x24 à laquelle on peut brancher des équerres et supports pour une installation extrêmement facile et rapide et le nouveau câble coaxial RG62 de Glomex, de haute qualité, à faible perte et de différentes longueurs avec un connecteur spécial FME, professionnel et miniaturisé déjà inséré dans une extrémité pour le installer dans l'antenne et avec un connecteur motorola pour assembler facilement votre système FM. Si, toutes fois, il est nécessaire d'avoir une antenne plus longue, vous pouvez utiliser la nouvelle extension construite avec les mêmes matériaux robustes sous-ensembles de l'antenne FM pour obtenir une esthétique exceptionnelle. Cette rallonge est facilement montable sur l'extrémité inférieure de l'antenne et est équipée d'une virole interne intégré 1"x14 pour faciliter son fixage sur toutes les supports Glomex. Toutes ces caractéristiques permettent à l'antenne d'être extrêmement flexible, ce qui permet au plaisancier, une grande liberté dans la composition du système FM et d'une installation extrêmement facile et rapide avec les différentes supports en option.

Quella in FM è una modalità di trasmissione diffusa nel VHF. Le bande FM infatti sono piuttosto immuni a disturbi e interferenze, garantendo una trasmissione e una ricezione chiara dei segnali. Le antenne FM sono spesso utilizzate per ascoltare le stazioni radiofoniche anche in navigazione. Glomex vuole semplificare la vita dei diportisti offrendo loro un'antenna universale FM robusta, performante e facilmente adattabile ad ogni esigenza. La nuova antenna, realizzata con le migliori materie prime, è composta da una canna in fibra di vetro, resistente alle sollecitazioni e trattata con materiali anti-ingiallimento, che protegge gli elementi interni in ottone.

Lunga 1,2m, l'antenna è indicata sia per l'installazione in testa d'albero al fine di avere le migliori performance di ricezione sia, grazie a varie basi opzionali, per l'installazione su imbarcazioni a motore. All'estremità inferiore l'antenna ha una boccia filettata 5/8"x24 su cui è possibile installare in maniera estremamente facile e rapida il nuovo cavo coassiale RG62 di Glomex. RG62 di altissima qualità e a bassa perdita offerto in varie lunghezze è già pre-installato, in una estremità, con lo speciale connettore FME, professionale e miniaturizzato per collegarlo all'antenna, mentre nell'altra estremità con un connettore motorola per assemblare facilmente il vostro sistema FM. Qualora, invece, fosse necessario avere un'antenna più lunga, è possibile utilizzare la nuova robusta prolunga di 1,2m, realizzata con gli stessi materiali costruttivi dell'antenna FM per ottenere un'estetica eccezionale. Tale prolunga è facilmente montabile sull'estremità inferiore dell'antenna ed è dotata di una boccia interna integrata 1"x14 per facilitare il suo fissaggio su qualsiasi base Glomex. Tutte queste caratteristiche permettono all'antenna di essere estremamente flessibile, consentendo al diportista una grande libertà nella composizione dell'impianto FM ed un'installazione estremamente facile e rapida, grazie anche ai vari supporti opzionali.

OPTIONAL ACCESSORIES



▲ RA303 - 1,2m (4') fiber-glass extension



▲ RA135FME 4 Way ratched mount in reinforced nylon, knob locking, thread 5/8"x24



▲ RA107SSFME 4 Way ratched mount in stainless steel, locking by clamp, with cable slot, 1"x14 standard thread

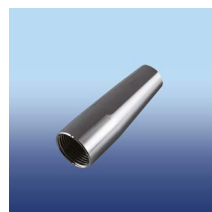

▲ RA358 Adaptor ferrule 5/8"x24 to 1"x14



▲ RA106BRACKINOX Electropolished stainless steel masthead bracket



▲ RA106BRACKINOX-L Electropolished stainless steel L masthead bracket



▲ RA352 FME male to PL259 male adaptor



▲ RA351 FME Female to SO239 Adaptor

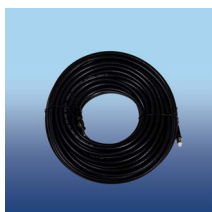

▲ RA360/6 6m (20') RG-62 low loss coaxial cable with pre-wired FME and mototola connectors



▲ RA350/18 18m (59') RG-62 low loss coaxial cable with pre-wired FME and mototola connectors



▲ RA350/30 30m (100') RG-62 low loss coaxial cable with pre-wired FME and mototola connectors

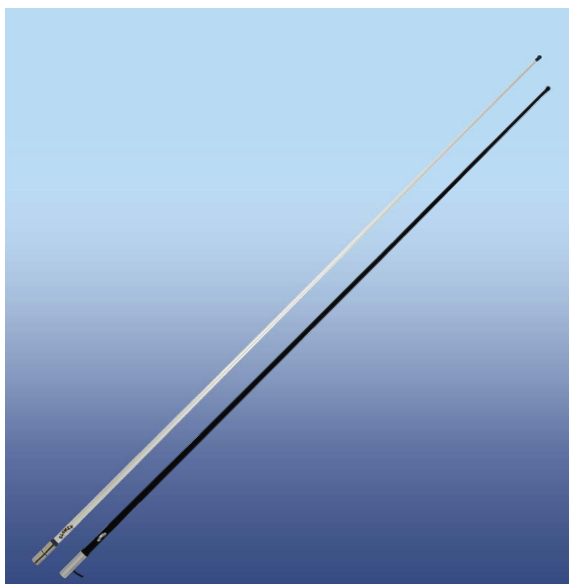

RA1288FME

2,4 m (8') FM fast fitting Glomeasy antenna with special stainless steel ferrule

Category: FM

Subcategory: 2,4m (8')

Code: RA1288FME, RA1288FME/BK



RA1288FME is the High performance 2.40 m (8') AM/FM antenna with FME termination, designed to assure excellent performance in terms of quality, operation and design.

Compared to the traditional antennas, whilst similar in shape, this antenna deeply differentiates itself due to two very important aspects:

- ▶ it has the FME termination for a very quick and more comfortable installation. Thanks to the FME termination, you will use the Glomex FME coaxial cables (code RA350), in different lengths, with a pre-installed professional, high quality and rugged FME connector that can be fitted on the antenna in a few seconds without soldering or cutting the cable;
- ▶ it has a stainless steel extremely resistant ferrule composed of two parts screwed one on the other to further facilitate the installation; Moreover, RA1288ME assure a clear transmission and reception of signals in any conditions.

For its installation, this antenna needs a mount with cable slot: RA107SSFME. The AM/FM is a common VHF transmission mode. AM/FM bands are less prone to disturbances and interferences assuring a clear transmission and reception of signals. AM/FM antennas are often used to listen to radio stations also during navigation.

FREQUENCY RANGE:	AM 550 / 1600 KHz - FM 88 / 108 MHz
IMPEDANCE:	93 ohms
ANTENNA LENGTH:	2.4m / 8'
ANTENNA WEIGHT:	750g / 26.3 oz
TERMINATION:	FME
<i>More info on www.glomex.it</i>	

Special Glomeasy Dual Ferrule for a very easy installation



RA1288FME est la nouvelle antenne colinéaire VHF haute 2,40 m avec la terminaison FME, conçue pour garantir d'excellentes performances en termes de qualité, de fonctionnalité et de design.

Par rapport aux antennes traditionnelles, dont elle ne conserve que l'apparence, cette antenne se différencie par deux aspects très importants :

- ▶ elle est dotée de la terminaison FME pour une facile installation. Merci à la terminaison FME, vous pouvez utiliser les câbles coaxiaux de Glomex (code RA350), en différentes longueurs, avec un connecteur pré-installé, professionnel, de haute qualité et robuste qui peut être monté sur l'antenne en quelques secondes sans soudure ou couper le câble;
- ▶ elle a une embase en acier inoxydable extrêmement résistant composé de deux parties vissées l'une sur l'autre afin de faciliter davantage l'installation; RA1288FME est une antenne qui garantit une transmission et une réception claire des signaux dans toutes les conditions.

Pour l'installation, elle nécessite d'un support avec passcable RA107SSFME. Le mode de transmission AM-FM est utilisée pour la VHF. Les bandes AM/FM ne sont pas gênées par les perturbations et les interférences, assurant une transmission et une réception claires des signaux. Les antennes AM/FM sont souvent employées pour écouter les stations radio même pendant la navigation.

RA1288FME è la nuova antenna AM/FM, lunga 2.40m e con la terminazione FME, progettata per garantire performances eccellenti in termini di qualità, funzionalità e design.

Rispetto alle antenne tradizionali, delle quali mantiene solo l'apparenza, si differenzia profondamente per due caratteristiche molto importanti:

- ▶ è dotata della terminazione FME per una installazione molto veloce e facile. Grazie alla terminazione FME, potrete utilizzare i cavi coassiali Glomex FME (codice RA350), in diverse lunghezze, con un connettore pre-installato, professionale, di alta qualità e robusto che può essere montato nell'antenna in un pochi secondi senza saldatura o tagliare il cavo;
- ▶ ha una boccola in acciaio inox estremamente resistente divisa in due parti avvitabili per facilitare ulteriormente l'installazione; Inoltre, RA1288FME è un'antenna che garantisce una trasmissione e una ricezione chiara dei segnali in qualsiasi condizione.

Per la sua installazione, occorre utilizzare una base con passacavo: RA107SSFME. Quella in AM/FM è una modalità di trasmissione diffusa nel VHF. Le bande AM/FM infatti sono piuttosto immuni a disturbi e interferenze, garantendo una trasmissione e una ricezione chiara dei segnali. Le antenne AM/FM sono spesso utilizzate per ascoltare le stazioni radiofoniche anche in navigazione.

OPTIONAL ACCESSORIES



▲ RA107SSFME 4 Way ratched mount in stainless steel, locking by clamp, with cable slot, 1"x14 standard thread

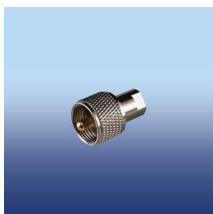

▲ RA352 FME male to PL259 male adaptor



▲ RA351 FME Female to SO239 Adaptor



▲ RA350/6FME 6m (20') RG-8X low loss coaxial cable with pre-wired FME connectors



▲ RA350/18FME 18m (59') RG-8X low loss coaxial cable with pre-wired FME connectors



▲ RA350/30FME 30m (100') RG-8X low loss coaxial cable with pre-wired FME connectors



RA300AIS

1,2 m (4') AIS 3dB fast fitting Glomeasy antenna

Category: AIS

Subcategory: 1,2m (4')

Code: RA300AIS, RA300AIS/BK



The Automatic Identification System (AIS) is a monitoring system of naval traffic, useful for navigation safety with difficult meteorological conditions (fog or nocturnal navigation). The AIS system operates on 2 expressly dedicated VHF channels (161.975 and 162.025 MHz) and allows the user to receive real time information about the traffic in the surrounding area. Glomex wants to make life easier for boat owners by offering a new universal, rugged, high performance and adaptable to every need AIS antenna RA300AIS.

The new antenna, made with the best raw materials, is composed of a fibreglass tube, resistant to stress and treated with anti-yellowing material, which protects the internal brass elements. Long 1.2 m (4'), with a gain of 3dB, the antenna is both for masthead installation in order to have the best transmission performance, and for the installation on motor boats thanks to various optional supports.

On the bottom, the antenna has a 5/8"x24 threaded ferrule that can be matched with optional brackets and mounts. Moreover, the antenna can be provided with the new Glomex high quality and low loss coaxial cable RG8X offered in various lengths and already pre-installed at both terminations with a special professional and miniaturized FME connector. If, however, it is necessary to have a longer antenna, you can use the new 1,2m (4') rugged extension RA301, made with the same construction materials of the AIS antenna to get outstanding aesthetics. This extension is easily mountable on the bottom of the antenna and is equipped with an internal, integrated 1"x14 ferrule to easily install it on any Glomex mounts. All these features allow boat owners to have a great freedom in the implementation of the AIS system and to have an extremely easy and fast installation, thanks to the FME-UHF adapter and various optional supports.

FREQUENCY RANGE:	161.975 / 162.025 MHz
GAIN AVERAGE:	3dB
IMPEDANCE:	50 ohms
SWR:	≤ 1.3 at 162 MHz
MAX INPUT POWER:	100 W
POLARIZATION:	Vertical
DC GROUND:	Yes
ANTENNA LENGHT:	1.2 / 4'
ANTENNA WEIGHT:	325g / 11.46 oz
TERMINATION:	FME
<i>More info on www.glomex.it</i>	



- ▶ Glomeasy Fast Fitting System
- ▶ No Soldering / No Cable Cutting

 L'Automatic Identification System (AIS) est un système de surveillance du trafic naval, utile pour la sécurité de la navigation dans des conditions météorologiques difficiles (brouillard ou navigation nocturne). Le système AIS fonctionne sur 2 canaux VHF dédiés (161.975 et 162.025 MHz) et permet de recevoir des informations sur le trafic alentour en temps réel. Glomex veut simplifier la vie aux plaisanciers en leurs offrant une antenne universelle AIS robuste, performante et facilement adaptable pour chaque exigence.

La nouvelle antenne, réalisée avec les meilleures matières premières, se compose d'une canne en fibre de verre, résistante aux contraintes, traitée avec un matériel anti-jaunissement, qui protège les éléments internes en laiton. Longue 1,2m avec un gain de 3 dB, l'antenne est indiquée pour l'installation en tête de mât du bateaux afin d'avoir la meilleure performance de réception et de transmission, et aussi, grâce aux diverses options de supports, peut être installée également sur des bateaux à moteur. Sur l'extrémité inférieure, l'antenne dispose d'une virole fileté 5/8"x24 à laquelle on peut brancher des équerres et supports pour une installation extrêmement facile et rapide et le nouveau câble coaxial RG62 de Glomex, de haute qualité, à faible perte et de différentes longueurs avec un connecteur spécial FME, professionnel et miniaturisé déjà inséré dans les deux extrémités.

Si, toutes fois, il est nécessaire d'avoir une antenne plus longue, vous pouvez utiliser la nouvelle extension construite avec les mêmes matériaux robustes sous-ensembles de l'antenne AIS pour obtenir une esthétique exceptionnelle. Cette rallonge est facilement montable sur l'extrémité inférieure de l'antenne et est équipée d'un virole interne intégré 1"x14 pour faciliter son fixage sur toutes les supports Glomex. Toutes ces caractéristiques permettent à l'antenne d'être extrêmement flexible, ce qui permet au plaisancier, une grande liberté dans la composition du système AIS et d'une installation extrêmement facile et rapide avec les différentes supports en option.

 L'Automatic Identification System (AIS) è un sistema di monitoraggio del traffico navale, utile per la sicurezza della navigazione in condizioni meteorologiche difficili (nebbia o navigazione notturna). Il sistema AIS funziona su 2 canali VHF appositamente dedicati (il 161,975 MHz e il 162,025 MHz) e consente di ricevere informazioni in tempo reale sul traffico nell'area circostante. Glomex vuole semplificare la vita dei diportisti offrendo loro un'antenna universale AIS robusta, performante e facilmente adattabile ad ogni esigenza.

La nuova antenna, realizzata con le migliori materie prime, è composta da una canna in fibra di vetro, resistente alle sollecitazioni e trattata con materiali anti-ingiallimento, che protegge gli elementi interni in ottone. Lunga 1,2m, con un guadagno di 3dB, l'antenna è indicata sia per l'installazione in testa d'albero al fine di avere le migliori performance di ricezione e trasmissione sia, grazie a varie basi opzionali, per l'installazione su imbarcazioni a motore. All'estremità inferiore l'antenna ha una boccia filettata 5/8"x24 su cui è possibile installare in maniera estremamente facile e rapida il nuovo cavo coassiale RG8X di Glomex di altissima qualità e a bassa perdita offerto in varie lunghezze e già pre-installato in entrambe le estremità con lo speciale connettore FME, professionale e miniaturizzato.

Qualora, invece, fosse necessario avere un'antenna più lunga, è possibile utilizzare la nuova robusta prolunga di 1,2m, realizzata con gli stessi materiali costruttivi dell'antenna AIS per ottenere un'estetica eccezionale. Tale prolunga è facilmente montabile sull'estremità inferiore dell'antenna ed è dotata di una boccia interna integrata 1"x14 per facilitare il suo fissaggio su qualsiasi base Glomex. Tutte queste caratteristiche permettono all'antenna di essere estremamente flessibile, consentendo al diportista una grande libertà nella composizione dell'impianto AIS ed un'installazione estremamente facile e rapida, grazie anche all'adattatore FME-UHF e ai vari supporti opzionali.

OPTIONAL ACCESSORIES



▲ RA135FME 4 Way ratched mount in reinforced nylon, knob locking, thread 5/8"x24



▲ RA107SSFME 4 Way ratched mount in stainless steel, locking by clamp, with cable slot, 1"x14 standard thread

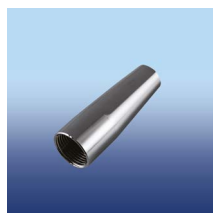

▲ RA358 Adaptor ferrule 5/8"x24 to 1"x14



▲ RA106BRACKINOX Electropolished stainless steel masthead bracket



▲ RA106BRACKINOX-L Electropolished stainless steel L masthead bracket

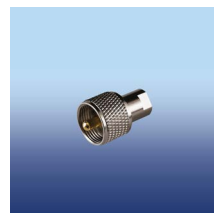

▲ RA352 FME male to PL259 male adaptor

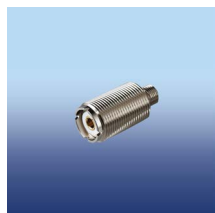

▲ RA351 FME Female to SO239 Adaptor



▲ RA350/3FME 3m (10') RG-8X low loss coaxial cable with pre-wired FME connectors



▲ RA350/6FME 6m (20') RG-8X low loss coaxial cable with pre-wired FME connectors



▲ RA350/12FME 12m (39') RG-8X low loss coaxial cable with pre-wired FME connectors



▲ RA350/18FME 18m (59') RG-8X low loss coaxial cable with pre-wired FME connectors



▲ RA350/25FME 25m (82') RG-8X low loss coaxial cable with pre-wired FME connectors



▲ RA350/30FME 30m (100') RG-8X low loss coaxial cable with pre-wired FME connectors

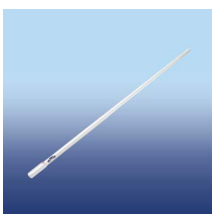

▲ RA303 - 1,2m (4') fiber-glass extension

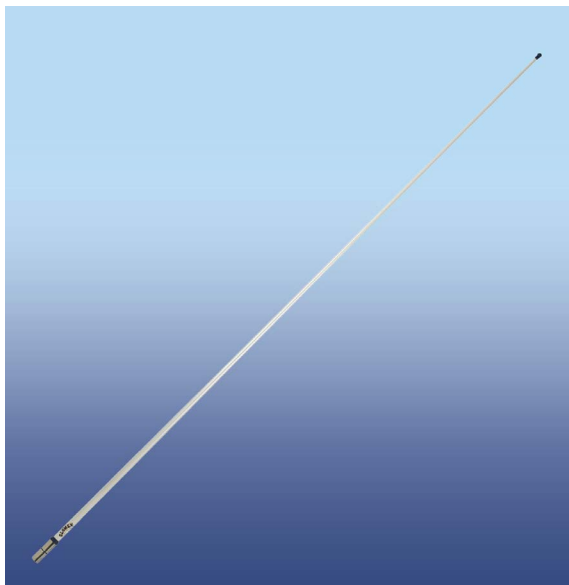

RA1225FME/AIS

2,4 m (8') AIS 6dB fast fitting Glomeasy antenna with special stainless steel ferrule

Category: AIS

Subcategory: 2,4m (8')

Code: RA1225FME/AIS



RA1225FME/AIS is the new 2.40 m (8') col-linear AIS antenna with FME termination, designed to assure excellent performance in terms of quality, operation and design. It has a special stainless steel ferrule for a very easy instalaltion.

Compared to the traditional antennas, whilst similar in shape, this antenna deeply differentiates itself due to two very important aspects:

- ▶ it has the FME termination for a very quick and more comfortable installation. Thanks to the FME termination, you will use the Glomex FME coaxial cables (code RA350), in different lengths, with a pre-installed professional, high quality and rugged FME connector that can be fitted on the antenna in a few seconds without soldering or cutting the cable;
- ▶ the inside finish and the rod features. Made of spiral copper wires inserted in brass tubes, this antenna assures a long-range communication and best radio performance. The tube is made of fibreglass with polished polyurethane finish and resistant to UV-rays and is reinforced by a double-layer (1,2 mm/0,05'.)

Moreover, RA1225FME/AIS is a vertical polarization antenna minimizing the effect of reflection on flat surfaces, always ensuring the best possible performance. For its installation, RA1225FME/AIS needs a moutn with cable slot: RA107SSFME

FREQUENCY RANGE:	161.975 / 162.025 MHz
GAIN AVERAGE:	6 dB
IMPEDANCE:	50 ohms
SWR:	≤ 1.3 at 162 MHz
MAX INPUT POWER:	100 W
POLARIZATION:	Vertical
DC GROUND:	Yes
ANTENNA LENGHT:	2.4m / 4'
ANTENNA WEIGHT:	750g / 26.3 oz
TERMINATION:	FME
<i>More info on www.glomex.it</i>	

Special Glomeasy Dual Ferrule for a very easy installation



RA1225FME/AIS est la nouvelle antenne colinéaire AIS haute 2,40 m avec la terminaison FME, conçue pour garantir d'excellentes performances en termes de qualité, de fonctionnalité et de design. Elle a une spéciale embase pour une installation très facile.

Par rapport aux antennes traditionnelles, dont elle ne conserve que l'apparence, cette antenne se différencie par deux aspects très importants :

- ▶ elle est dotée de la terminaison FME pour une facile installation. Merci à la terminaison FME, vous pouvez utiliser les câbles coaxiaux de Glomex (code RA350), en différentes longueurs, avec un connecteur pré-installé, professionnel, de haute qualité et robuste qui peut être monté sur l'antenne en quelques secondes sans soudure ou couper le câble ;
- ▶ ses finitions intérieures et par les caractéristiques de son foyeu. Fabriquée en fils de cuivre en spirale insérés dans des tubes en laiton, cette antenne assure une communication de longue portée et une très bonne réception radio. Le tube en fibres de verre avec finition en polyuréthane brillant résistant aux rayons UV, est renforcé par un tube à double épaisseur (1,2 mm/0,05') qui en renforce la structure.

RA1225FME est une antenne à polarisation verticale qui minimise les effets de réflexion sur des surfaces planes, en garantissant toujours le meilleur rendement possible. Pour l'installation, elle nécessite d'un support avec passacable RA107SSFME/AIS

RA1225FME/AIS è la nuova antenna collineare alta 2.40 m con la terminazione FME, progettata per garantire performances eccellenti in termini di qualità, funzionalità e design.

Dotata di una speciale boccola in acciaio inox per una facile installazione. Rispetto alle antenne tradizionali, delle quali mantiene solo l'apparenza, si differenzia profondamente per due caratteristiche molto importanti:

- ▶ è dotata della terminazione FME per una installazione molto veloce e facile. Grazie alla terminazione FME, potrete utilizzare i cavi coassiali Glomex FME (codice RA350), in diverse lunghezze, con un connettore pre-installato, professionale, di alta qualità e robusto che può essere montato nell'antenna in un pochi secondi senza saldatura o tagliare il cavo ;
- ▶ le finiture interne e le caratteristiche dello stilo. Costruita con fili di rame spiralato inseriti in tubi d'ottone, assicura una comunicazione a lungo raggio e prestazioni ottimali delle radio. Il tubo, realizzato in fibra di vetro con finiture in poliuretano lucido resistente ai raggi U.V., presenta un tubo a doppio spessore (1,2 mm/0,05') che ne rinforza la struttura.

Inoltre, RA1225FME/AIS è un'antenna a polarizzazione verticale che minimizza gli effetti di riflessione sulle superfici piane garantendo sempre le migliori prestazioni possibili. Per la sua installazione, occorre utilizzare una base con passacavo: RA107SSFME.

OPTIONAL ACCESSORIES



▲ RA107SSFME 4 Way ratched mount in stainless steel, locking by clamp, with cable slot, 1"x14 standard thread

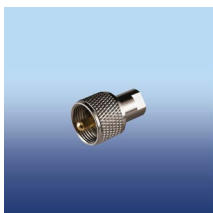

▲ RA352 FME male to PL259 male adaptor



▲ RA351 FME Female to SO239 Adaptor



▲ RA350/3FME 3m (10') RG-8X low loss coaxial cable with pre-wired FME connectors



▲ RA350/6FME 6m (20') RG-8X low loss coaxial cable with pre-wired FME connectors



▲ RA350/12FME 12m (39') RG-8X low loss coaxial cable with pre-wired FME connectors



▲ RA350/18FME 18m (59') RG-8X low loss coaxial cable with pre-wired FME connectors



▲ RA350/25FME 25m (82') RG-8X low loss coaxial cable with pre-wired FME connectors



▲ RA350/30FME 30m (100') RG-8X low loss coaxial cable with pre-wired FME connectors



RA304AIS

250 mm (10") white 3db small deck and regatta ais glo-measy antenna

Category: AIS

Subcategory: 250mm (10")

Code: RA304AIS, RA304AIS/BK



🇮🇹 Glomex wants to make life easier for boat owners by offering a new very compact, rugged, high performance, adaptable to every need and fast fitting AIS antenna. The new antenna, made with the best raw materials, is composed of a fibreglass tube, resistant to stress and treated with anti-yellowing material, which protects the internal brass elements. Long 250mm (10"), with a gain of 3dB, the antenna is both for masthead installation in order to have the best transmission performance, and for the installation on motor boats thanks to various optional supports.

On the bottom, the antenna has a 5/8"x24 threaded ferrule that can be matched with optional brackets and mounts. Moreover, the antenna can be provided with the Glomeasy high quality and low loss coaxial cable RG8X offered in various lengths and already pre-installed at both terminations with a special professional and miniaturized FME connector. All these features allow boat owners to have a great freedom in the implementation of the AIS system and to have an extremely easy and fast installation, thanks to the FME-UHF adapter and various optional supports.

FREQUENCY RANGE:	161.975/162.025 MHz
GAIN AVERAGE:	3 dB
IMPEDANCE:	50 ohms
SWR:	≤ 1,3 at 156,8 MHz
MAX INPUT POWER:	100 W
POLARIZATION:	Vertical
DC GROUND:	Yes
ANTENNA LENGHT:	250mm (10")
ANTENNA WEIGHT:	150g
TERMINATION:	FME
<i>More info on www.glomex.it</i>	



- ▶ Glomeasy Fast Fitting System
- ▶ No Soldering / No Cable Cutting

 Glomex veut simplifier la vie aux plaisanciers en leur offrant une antenne AIS très compacte, robuste, performante, facilement adaptable pour chaque exigence et très rapide à installer. La nouvelle antenne, réalisée avec les meilleures matières premières, se compose d'une canne en fibre de verre, résistante aux contraintes, traitée avec un matériel anti-jaunissement, qui protège les éléments internes en laiton. Longue 250mm avec un gain de 3dB, l'antenne est indiquée pour l'installation en tête de mât du bateaux afin d'avoir la meilleure performance de réception et de transmission, et aussi, grâce aux diverses options de supports, peut être installée également sur des bateaux à moteur.

Sur l'extrémité inférieure, l'antenne dispose d'une virole fileté 5/8"x24 à laquelle on peut brancher des équerres et supports pour une installation extrêmement facile et rapide et le nouveau câble coaxial RG8X Glomeasy, de haute qualité, à faible perte et de différentes longueurs avec un connecteur spécial FME, professionnel et miniaturisé déjà inséré dans les deux extrémités. Toutes ces caractéristiques permettent à l'antenne d'être extrêmement flexible, ce qui permet au plaisancier, une grande liberté dans la composition du système AIS et d'une installation extrêmement facile et rapide avec les différentes supports en option. All these features allow boat owners to have a great freedom in the implementation of the AIS system and to have an extremely easy and fast installation, thanks to the FME-UHF adapter and various optional supports.

 Glomex vuole semplificare la vita dei diportisti offrendo loro un'antenna AIS molto compatta, robusta, performante, facilmente adattabile ad ogni esigenza e estremamente veloce da installare. La nuova antenna, realizzata con le migliori materie prime, è composta da una canna in fibra di vetro, resistente alle sollecitazioni e trattata con materiali anti-ingiallimento, che protegge gli elementi interni in ottone. Lunga 250mm, con un guadagno di 3dB, l'antenna è indicata sia per l'installazione sul ponte e in testa d'albero al fine di avere le migliori performance di ricezione e trasmissione.

All'estremità inferiore l'antenna ha una boccola filettata 5/8"x24 su cui è possibile installare in maniera estremamente facile e rapida il nuovo cavo coassiale RG8X Glomeasy di altissima qualità e a bassa perdita offerto in varie lunghezze e già pre-installato in entrambe le estremità con lo speciale connettore FME, professionale e miniaturizzato. Tutte queste caratteristiche permettono all'antenna di essere estremamente flessibile, consentendo al diportista una grande libertà nella composizione dell'impianto AIS ed un'installazione estremamente facile e rapida, grazie anche all'adattatore FME-UHF e ai vari supporti opzionali.

OPTIONAL ACCESSORIES



▲ RA135FME 4 Way ratched mount in reinforced nylon, knob locking, thread 5/8"x24



▲ RA1075SFME 4 Way ratched mount in stainless steel, locking by clamp, with cable slot, 1"x14 standard thread

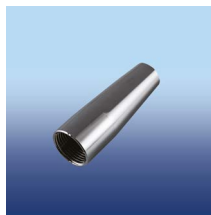

▲ RA358 Adaptor ferrule 5/8"x24 to 1"x14



▲ RA106BRACKINOX Electropolished stainless steel masthead bracket



▲ RA106BRACKINOX-L Electropolished stainless steel L masthead bracket



▲ RA369 Deck flange with nut and washer - chrome plated.

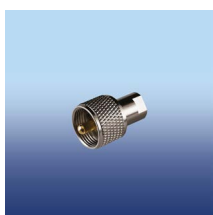

▲ RA352 FME male to PL259 male adaptor

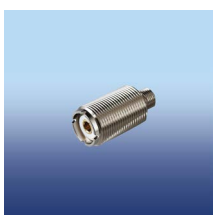

▲ RA351 FME Female to SO239 Adaptor



▲ RA350/3FME 3m (10') RG-8X low loss coaxial cable with pre-wired FME connectors



▲ RA350/6FME 6m (20') RG-8X low loss coaxial cable with pre-wired FME connectors



▲ RA350/12FME 12m (39') RG-8X low loss coaxial cable with pre-wired FME connectors



▲ RA350/18FME 18m (59') RG-8X low loss coaxial cable with pre-wired FME connectors



▲ RA350/25FME 25m (82') RG-8X low loss coaxial cable with pre-wired FME connectors



▲ RA350/30FME 30m (100') RG-8X low loss coaxial cable with pre-wired FME connectors



RA300DAB

1,2 m (4') DAB 3dB fast fitting Glomeasy antenna

Category: DAB

Subcategory: 1,2m (4')

Code: RA300DAB, RA300DAB/BK



🇬🇧 DAB is a digital radio broadcasting system that through the application of multiplexing and compression combines multiple audio streams onto a relatively narrow band centred on a single broadcast frequency called a DAB ensemble. So, with our DAB antenna you can receive more radio stations and with a better quality also during navigation. Glomex wants to make life easier for boat owners by offering a new universal, rugged, high performance and adaptable to every need DAB antenna RA300DAB. The new antenna, made with the best raw materials, is composed of a fibreglass tube, resistant to stress and treated with anti-yellowing material, which protects the internal brass elements. Long 1.2 m (4'), the antenna is both for masthead installation in order to have the best receiving performance, and for the installation on motor boats thanks to various optional supports.

On the bottom, the antenna has a 5/8"x24 threaded ferrule that can be matched with optional brackets and mounts. Moreover, the antenna can be provided with the new Glomex high quality and low loss coaxial cable RG8X offered in various lengths and already pre-installed at one side with a special professional and miniaturized FME connector to install it on the antenna and, on the other side, with a Motorola plug to easily assemble your DAB system. If, however, it is necessary to have a longer antenna, you can use the new 1,2m (4') rugged extension RA301, made with the same construction materials of the DAB antenna to get outstanding aesthetics. This extension is easily mountable on the bottom of the antenna and is equipped with an internal, integrated 1"x14 ferrule to easily install it on any Glomex mounts. All these features allow boat owners to have a great freedom in the implementation of the DAB system and to have an extremely easy and fast installation, thanks to various optional supports.

FREQUENCY RANGE:	174 / 240 MHz
IMPEDANCE:	50 ohms
POLARIZATION:	Vertical
ANTENNA LENGHT:	1.2 / 4'
ANTENNA WEIGHT:	325g / 11.46 oz
TERMINATION:	FME
<i>More info on www.glomex.it</i>	



- ▶ **Glomeasy Fast Fitting System**
- ▶ **No Soldering / No Cable Cutting**

DAB est un système de radiodiffusion numérique qui, par l'application de la compression et de multiplexage, combine plusieurs flux audio sur une bande relativement étroite, centrée sur une fréquence unique de diffusion appelé DAB ensemble. Donc, avec notre antenne DAB, vous pouvez recevoir plus stations radio et avec une meilleure qualité même pendant la navigation. Glomex veut simplifier la vie aux plaisanciers en leur offrant une antenne universelle DAB robuste, performante et facilement adaptable pour chaque exigence. La nouvelle antenne, réalisée avec les meilleures matières premières, se compose d'une canne en fibre de verre, résistante aux contraintes, traitée avec un matériel anti-jaunissement, qui protège les éléments internes en laiton. Longue 1,2m, l'antenne est indiquée pour l'installation en tête de mât du bateau afin d'avoir la meilleure performance de réception, et aussi, grâce aux diverses options de supports, peut être installée également sur des bateaux à moteur.

Sur l'extrémité inférieure, l'antenne dispose d'une virole fileté 5/8"x24 à laquelle on peut brancher des équerres et supports pour une installation extrêmement facile et rapide et le nouveau câble coaxial RG62 de Glomex, de haute qualité, à faible perte et de différentes longueurs avec un connecteur spécial FME, professionnel et miniaturisé déjà inséré dans une extrémité pour le installer dans l'antenne et avec un connecteur motorola pour assembler facilement votre système DAB. Si, toutes fois, il est nécessaire d'avoir une antenne plus longue, vous pouvez utiliser la nouvelle extension construite avec les mêmes matériaux robustes sous-ensembles de l'antenne DAB pour obtenir une esthétique exceptionnelle. Cette rallonge est facilement montable sur l'extrémité inférieure de l'antenne et est équipée d'un virole interne intégré 1"x14 pour faciliter son fixage sur toutes les supports Glomex. Toutes ces caractéristiques permettent à l'antenne d'être extrêmement flexible, ce qui permet au plaisancier, une grande liberté dans la composition du système DAB et d'une installation extrêmement facile et rapide avec les différentes supports en option.

DAB è un sistema di trasmissione radio digitale che, attraverso l'applicazione di multiplexing e la compressione, combina più flussi audio su una banda relativamente stretta centrata su una sola frequenza di trasmissione chiamata un DAB ensemble. Così, con la nostra antenna DAB è possibile ricevere più stazioni radiofoniche e con una qualità migliore anche durante la navigazione. Glomex vuole semplificare la vita dei diportisti offrendo loro un'antenna universale DAB robusta, performante e facilmente adattabile ad ogni esigenza. La nuova antenna, realizzata con le migliori materie prime, è composta da una canna in fibra di vetro, resistente alle sollecitazioni e trattata con materiali anti-ingiallimento, che protegge gli elementi interni in ottone. Lunga 1,2m, l'antenna è indicata sia per l'installazione in testa d'albero al fine di avere le migliori performance di ricezione sia, grazie a varie basi opzionali, per l'installabile su imbarcazioni a motore.

All'estremità inferiore l'antenna ha una boccola filettata 5/8"x24 su cui è possibile installare in maniera estremamente facile e rapida il nuovo cavo coassiale RG8X di Glomex di altissima qualità e a bassa perdita offerto in varie lunghezze e già pre-installato, in una estremità, con lo speciale connettore FME, professionale e miniaturizzato per collegarlo all'antenna, mentre nell'altra estremità con un connettore motorola per assemblare facilmente il vostro sistema DAB. Qualora, invece, fosse necessario avere un'antenna più lunga, è possibile utilizzare la nuova robusta prolunga di 1,2m, realizzata con gli stessi materiali costruttivi dell'antenna DAB per ottenere un'estetica eccezionale. Tale prolunga è facilmente montabile sull'estremità inferiore dell'antenna ed è dotata di una boccola interna integrata 1"x14 per facilitare il suo fissaggio su qualsiasi base Glomex. Tutte queste caratteristiche permettono all'antenna di essere estremamente flessibile, consentendo al diportista una grande libertà nella composizione dell'impianto DAB ed un'installazione estremamente facile e rapida, grazie anche ai vari supporti opzionali.

OPTIONAL ACCESSORIES



▲ RA135FME 4 Way ratched mount in reinforced nylon, knob locking, thread 5/8"x24



▲ RA107SSFME 4 Way ratched mount in stainless steel, locking by clamp, with cable slot, 1"x14 standard thread

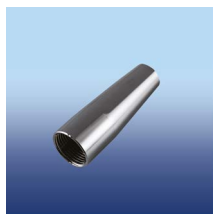

▲ RA358 Adaptor ferrule 5/8"x24 to 1"x14



▲ RA106BRACKINOX Electropolished stainless steel masthead bracket



▲ RA106BRACKINOX-L Electropolished stainless steel L masthead bracket

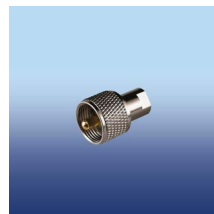

▲ RA352 FME male to PL259 male adaptor



▲ RA351 FME Female to SO239 Adaptor



▲ RA350/3FME 3m (10') RG-8X low loss coaxial cable with pre-wired FME connectors



▲ RA350/6FME 6m (20') RG-8X low loss coaxial cable with pre-wired FME connectors



▲ RA350/12FME 12m (39') RG-8X low loss coaxial cable with pre-wired FME connectors



▲ RA350/18FME 18m (59') RG-8X low loss coaxial cable with pre-wired FME connectors



▲ RA350/25FME 25m (82') RG-8X low loss coaxial cable with pre-wired FME connectors



▲ RA350/30FME 30m (100') RG-8X low loss coaxial cable with pre-wired FME connectors



▲ RA303 - 1,2m (4') fiber-glass extension



RA135FME

4 way ratched mout in reinforced nylon - knob locking - hole for cable - thread 5/8"x24

Category: Accessories

Subcategory: Deck mounts

Code: RA135FME



GLOMEASY

- 🇺🇸 4 way ratchet mount in reinforced nylon UV resistant design with knob, for deck or bulkhead.

Hole and feed-thru for coax cable. Usable with Glomeasy antennas: RA106SLSFME, R106GRPFME and RA300. Thread 5/8"x24

- 🇫🇷 Support double articulation en nylon traité anti-UV pour fixation sur pont ou cloison, avec blocage par molette.

Passacâble pour câble coaxial. Pour antennes Glomeasy: RA106SLSFME, RA106GRPFME et RA300. Filetage 5/8"x24.

- 🇮🇹 Base a doppio snodo in nylon rinforzato resistente ai raggi UV con bloccaggio a manopola, per pulpito o ponte.

Con PASSACAVO IMPERMEABILE. Utilizzabile con antenne della linea Glomeasy: RA106SLSFME, RA106GRPFME e RA300. Filettatura 5/8"x24.

RA107SSFME



4 way ratched mount in stainless steel - locking by clamp - cable slot - standard thread 1"x14

Category: Accessories

Subcategory: Deck mounts

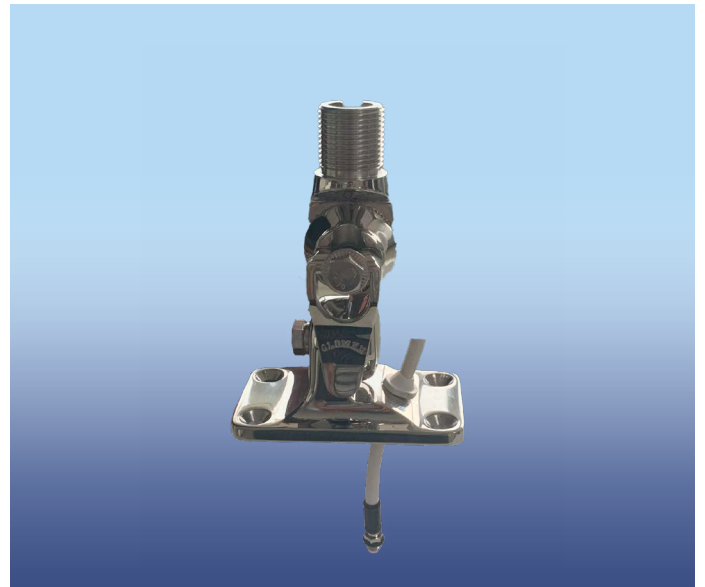
Code: RA107SSFME



-  4 way ratchet mount polished stainless steel design with clamp. Hole and feed-thru for coax cable. Standard 1"x14 thread. With special cable slot for a very easy passage of the cable without removal of most factory installed connectors
-  Support double articulation en acier inoxydable poli, avec blocage à cliquet. Passacâble pour câble coaxial et GPS. Filetage standard 1"x14.
-  Base a doppio snodo in acciaio inox elettrolucidato Aisi 316, per una totale protezione dalla corrosione e dagli agenti atmosferici. Bloccaggio a levetta a scatto e PASSACAVO IMPERMEABILE. Dotata di slot laterale per cavo coassiale per il passaggio rapido senza la rimozione del connettore preinstallato. Filettatura standard 1"x14.



🇬🇧 Deck flange with nut and washer - chrome plated.



🇬🇧 Nylon feed -thru for deck passage of 1 or 2 coaxial cables and connectors

RA369

Deck flange with nut and washer - chrome plated

Category: Accessories

Subcategory: Deck mounts

Code: RA369



🇫🇷 Bride de plancher avec ecrou et rondelle.

🇮🇹 Flangia per ponte con dado e rondella in ottone cromato

RA140

Nylon feed-thru for deck passage of 1 or 2 coaxial cables and connectors

Category: Accessories

Subcategory: Deck mounts

Code: RA140



🇫🇷 Passe-fils en nylon pour 1 ou 2 cables coaxiaux et connecteurs

🇮🇹 Passacavo in nylon per 1 o 2 cavi coassiali con connettore montato

RA140U

Brass chromed feed through for cable 1/4" (6mm)

Category: Accessories

Subcategory: Deeck mounts

Code: RA140U





RA106BRACKINOX-L

Electropolished stainless steel L masthead bracket

Category: Accessories

Subcategory: Masthead brackets

Code: RA106BRACKINOX-L



- 🇬🇧 Electropolished stainless steel L masthead bracket
- 🇫🇷 Support en L en acier inoxydable électro-poli pour installation sur tête de mât.
- 🇮🇹 Staffa in acciaio inox elettrolucidato AISI 316 per installazione in testa d'albero.



RA106BRACKINOX

Electropolished stainless steel masthead bracket

Category: Accessories

Subcategory: Masthead brackets

Code: RA106BRACKINOX



- 🇬🇧 Electropolished stainless steel masthead bracket
- 🇫🇷 Support en acier inoxydable électro-poli pour installation sur tête de mât.
- 🇮🇹 Staffa in acciaio inox elettrolucidato Aisi 316 per installazione in testa d'albero

RA358

Adaptor ferrule 5/8"x24 to 1"x14 for RA300/RA304 series

Category: Accessories

Subcategory: Deck mounts

Code: RA358



🇬🇧 Chrome brass adaptor ferrule 5/8"x24 to 1"x14. It allows to use any 1"x14 thread mounts with Glomeasy RA300/RA304 antenna series

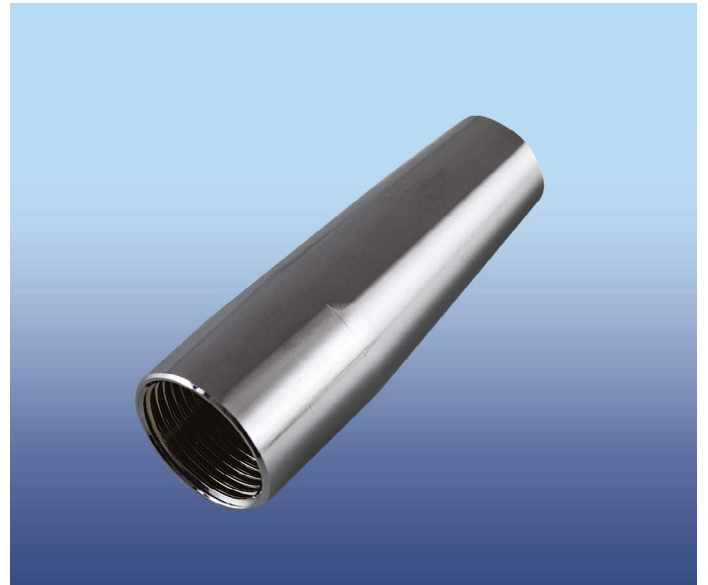

🇫🇷 Embase adaptateur en laiton chromé 5/8"x24 / 1"x14

🇮🇹 Boccola adattatore in ottone cromato 5/8"x24 / 1"x14 per antenne RA300 e RA304

RA134FME

Rail swivel mount in reinforced nylon for glomeasy antennas - horizontal and vertical rail - knob locking - hole for cable - standard thread 5/8"x24

Category: Accessories

Subcategory: Rail mounts

Code: RA134FME



🇬🇧 Rail ratchet mount in reinforced anti-yellowing nylon UV resistant for Glomeasy antennas, locking by knob Easy installation on vertical and horizontal rails of 7/8" (22 mm) and 1" (25mm). 5/8"x24 thread.

🇮🇹 Supporto a snodo in nylon rinforzato anti-ingiallimento resistente ai raggi UV per antenne Glomeasy (cod. RA300, RA300FN, RA300AIS, RA300DAB, RA106GRPFME e RA106LSFME). Bloccaggio a manopola – Installazione verticale od orizzontale su tubo di diametro compreso tra 22 e 25 mm. Filettatura standard 5/8"x24.



🇫🇷 Rotule en nylon renforcé traité anti-UV pour antenne Glomeasy. Blocage par molette. Fixation horizontale ou verticale sur balcon diamètre de 22 a 25 mm. Filetage 5/8"x24.

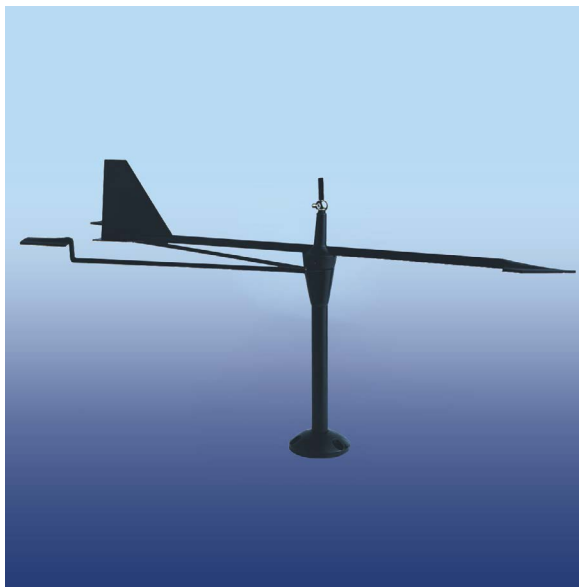

RA179

Wind indicator for masthead or antennas RA106SLS SB and RA109 series.

Category: Accessories

Subcategory: Masthead brackets

Code: RA179



- 🇬🇧 Wind indicator 12" (300 mm) for masthead or VHF antennas RA106SLS SB (with stainless steel whip) and RA109 series.
- 🇫🇷 Girouette de 300mm pour tête de mat ou antennes série RA106SLS SB (avec un fouet en acier inoxydable) et RA109.
- 🇮🇹 Indicatore vento 300 mm (12") per testa d'albero o antenne VHF delle serie RA106SLS SB (con stilo in acciaio inox) e RA109.



RA351

FME Female To SO239 Adaptor

Category: Accessories

Subcategory: Connector/adaptor

Code: RA351



- 🇬🇧 RA351 is very easy to be installed on Glomeasy antennas for using a coaxial cable with a PL259 connector.
- 🇫🇷 RA351 est tres facile à installer sur les antennes Glomeasy et permet de connecter l'antenne à un cable coaxial avec un connecteur PL259.
- 🇮🇹 L'adattatore RA351 si installa velocemente sulla terminazione delle antenne Glomeasy e consente di utilizzare un cavo coassiale con un connettore PL259.



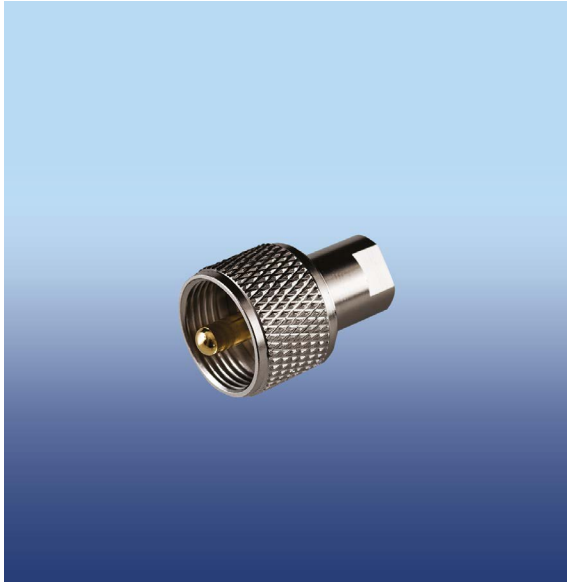

 FME male to PL259 male adaptor

RA352

FME male to PL259 male adaptor

Category: Accessories

Subcategory: Connector/adaptor

Code: RA352



 Adaptateur FME mâle / PL259 mâle.

 Adattatore FME maschio / PL259 maschio.



 Uhf PL259 male crimp-type connector for RG-8X coax cable

RA353

Uhf PL259 male crimp-type connector for RG-8X coax cable

Category: Accessories

Subcategory: Connector/adaptor

Code: RA353



 Connecteur UHF PL259 mâle a crimper pour câble coaxial RG8X.

 Connettore uhf PL259 maschio - tipo crimpato - per RG-8X.

RA354

FME male to N male adaptor

Category: Accessories

Subcategory: Connector/adaptor

Code: RA354



 FME male to N male adaptor



 Adaptateur FME mâle / N mâle.

 Adattatore FME maschio / N maschio.

RA355

FME male to BNC male adaptor

Category: Accessories

Subcategory: Connector/adaptor

Code: RA355



 FME male to BNC male adaptor



 Adaptateur FME mâle / BNC mâle.

 Adattatore FME maschio / BNC maschio.



🇬🇧 FME male to TNC male adaptor

RA356

FME male to TNC male adaptor

Category: Accessories

Subcategory: Connector/adaptor

Code: RA356



🇮🇹 Adaptateur FME male / TNC male

🇮🇹 Adattatore FME maschio / TNC maschio.



🇬🇧 FME male to FME male (double-male fme) to connect to glomeasy coax cables

RA357

FME male to FME male (double-male fme)

Category: Accessories

Subcategory: Connector/adaptor

Code: RA357



🇮🇹 FME mâle / FME mâle (double-mâle FME) pur connecter plus cable coaxial glomeasy.

🇮🇹 Connettore prolunga - doppio FME maschio.

RA362

Straight SMB plug to FME plug adapter for DAB radio and Glomeasy RA300DAB

Category: Accessories

Subcategory: Connector/adaptor

Code: RA362



🇬🇧 Straight SMB plug to FME plug adapter for DAB radio and Glomeasy RA300DAB

🇫🇷 Adaptateur SMB / FME mâle pour antennes DAB Glomeasy.

🇮🇹 Adattatore smb / fme maschio per radio dab e antenna ra-300dab.

RA371

FAKRA Z female / FME male for dab radio and glomeasy ra300dab

Category: Accessories

Subcategory: Connector/adaptor

Code: RA371



🇬🇧 FAKRA Z female / FME male for DAB radio and Glomeasy RA300DAB

🇫🇷 FAKRA Z femmina / FME maschio per radio DAB

🇮🇹 Adattatore FAKRA Z femmina / FME maschio per radio DAB



RA138

Synthetic rubber threaded protection for PL259 connectors

Category: Accessories

Subcategory: Connector/adaptor

Code: RA138



🇬🇧 Synthetic rubber threaded protection for PL259 connectors

🇮🇹 Manchon d'étanchéité caoutchouc pour connecteurs PL259.

🇮🇹 Protezione in gomma sintetica per connettori PL259



RA350/3FME

3 m (10') RG-8X low loss coaxial cable with pre-wired fme connectors - 50 OHMS - white

Category: Coax cables

Subcategory: 50 Ohm

Code: RA350/3FME



🇬🇧 RG8X low loss coaxial cable for Glomeasy VHF, AIS and DAB antennas: RA106SLSFME, RA106GRPFME, RA300, RA300AIS and RA300DAB. Long 3m (10'), has pre-installed FME connectors on both termination for a very easy and fast intallation. This type of coaxial cable is available also in other lenghts: 6m (20') 12m (39') 18m (59') 25m (82') 30m (99').

🇮🇹 RG8X câble coaxial à faible perte pour les antennes VHF, AIS et DAB Glomeasy. Long 3m, a les connecteur FME préinstallé dans les deux terminaisons pour un installation tres rapid et facile. Ce type de cable coaxial est disponible aussi avec autres different longueurs:- 6m- 12m- 18m- 24m- 30m.

🇮🇹 Cavo coassiale RG8X lungo 3 m, a bassa perdita per le antenne VHF, AIS e DAB Glomeasy RA106SLSFME, RA106GRPFME, RA300, RA300AIS e RA300DAB. Il cavo ha i connettori FME COSTAMPATI pre-installati su entrambe le terminazioni per un'installazione estremamente facile e rapida. Tale tipo di cavo coassiale è disponibile anche nelle seguenti lunghezze: 6m 12m 18m 25m 30m.

RA350/6FME

6 m (20') RG-8X low loss coaxial cable with pre-wired fme connectors - 50 OHMS - white

Category: Coax cables

Subcategory: 50 Ohm

Code: RA350/6FME



🇬🇧 RG8X low loss coaxial cable for Glomeasy VHF, AIS and DAB antennas: RA106SLSFME, RA106GRPFME, RA300, RA300AIS and RA300DAB. Long 6m (20'), has pre-installed FME connectors on both termination for a very easy and fast intallation.This type of coaxial cable is available also in other lengths: 3m (10') 12m (39') 18m (59') 25m (82') 30m (99').

🇫🇷 RG8X câble coaxial à faible perte pour les antennes VHF, AIS et DAB Glomeasy. Long 6m, a les connecteur FME préinstallé dans les deux terminaisons pour un installation tres rapid et facile. Ce type de cable coaxial est disponible aussi avec autres different longueurs: - 3m- 12m- 18m - 24m- 30m.

🇮🇹 Cavo coassiale RG8X lungo 6 m, a bassa perdita per le antenne VHF, AIS e DAB Glomeasy RA106SLSFME, RA106GRPFME, RA300, RA300AIS e RA300DAB. Il cavo ha i connettori FME COSTAMPATI pre-installati su entrambe le terminazioni per un'installazione estremamente facile e rapida. Tale tipo di cavo coassiale è disponibile anche nelle seguenti lunghezze: 3m 12m 18m 25m 30m.

RA350/12FME

12 m (39') RG-8X low loss coaxial cable with pre-wired fme connectors - 50 OHMS - white

Category: Coax cables

Subcategory: 50 Ohm

Code: RA350/12FME



🇬🇧 RG8X low loss coaxial cable for Glomeasy VHF, AIS and DAB antennas: RA106SLSFME, RA106GRPFME, RA300, RA300AIS and RA300DAB. Long 12m (39'), has pre-installed FME connectors on both termination for a very easy and fast installation. This typer of coaxial cable is available also in other lengths: 3m (10') 6m (20') 18m (59') 25m (78') 30m (99').

🇫🇷 RG8X câble coaxial à faible perte pour les antennes VHF, AIS et DAB Glomeasy. Long 12m, a les connecteur FME préinstallé dans les deux terminaisons pour un installation tres rapid et facile Ce type de cable coaxial est disponible aussi avec autres different longueurs: - 3m - 6m - 18m - 24m - 30m.

🇮🇹 Cavo coassiale RG8X lungo 12m, a bassa perdita per le antenne VHF, AIS e DAB Glomeasy RA106SLSFME, RA106GRPFME, RA300, RA300AIS e RA300DAB. Il cavo ha i connettori FME COSTAMPATI pre-installati su entrambe le terminazioni per un'installazione estremamente facile e rapida. Tale tipo di cavo coassiale è disponibile anche nelle seguenti lunghezze: 3m 6m 18m 25m 30m.



RA350/18FME

18 m (59') RG-8X low loss coaxial cable with pre-wired fme connectors - 50 OHMS - white

Category: Coax cables

Subcategory: 50 Ohm

Code: RA350/18FME



🇬🇧 RG8X low loss coaxial cable for Glomeasy VHF, AIS and DAB antennas: RA106SLSFME, RA106GRPFME, RA300, RA300AIS and RA300DAB. Long 18m (59'), has pre-installed FME connectors on both termination for a very easy and fast intallation. This type of coaxial cable is available also in other lenghts: 3m (10') 6m (20') 12m (39') 25m (82') 30m (99').

🇫🇷 RG8X câble coaxial à faible perte pour les antennes VHF, AIS et DAB Glomeasy. Long 18m, a les connecteur FME préinstallé dans les deux terminaisons pour un installation tres rapid et facile Ce type de cable coaxial est disponible aussi avec autres different longueurs:- 3m- 6m- 12m- 24m- 30m.

🇮🇹 Cavo coassiale RG8X lungo 18m, a bassa perdita per le antenne VHF, AIS e DAB Glomeasy RA106SLSFME, RA106GRPFME, RA300, RA300AIS e RA300DAB. Il cavo ha i connettori FME COSTAMPATI pre-installati su entrambe le terminazioni per un'installazione estremamente facile e rapida. Tale tipo di cavo coassiale è disponibile anche nelle seguenti lunghezze: 3m 6m 12m 25m 30m.



RA350/25FME

25 m (82') RG-8X low loss coaxial cable with pre-wired fme connectors - 50 OHMS - white

Category: Coax cables

Subcategory: 50 Ohm

Code: RA350/25FME



🇬🇧 RG8X low loss coaxial cable for Glomeasy VHF, AIS and DAB antennas: RA106SLSFME, RA106GRPFME, RA300, RA300AIS and RA300DAB. Long 25m (82'), has pre-installed FME connectors on both termination for a very easy and fast intallation. This type of coaxial cable is available also in other lenghts: 3m (10') 6m (20') 12m (39') 18m (59') 30m (99').

🇫🇷 RG8X câble coaxial à faible perte pour les antennes VHF, AIS et DAB Glomeasy. Long 25m, a les connecteur FME préinstallé dans les deux terminaisons pour un installation tres rapid et facile. Ce type de cable coaxial est disponible aussi avec autres different longueurs:- 3m - 6m - 12m- 18m- 30m.

🇮🇹 Cavo coassiale RG8X lungo 25m, a bassa perdita per le antenne VHF, AIS e DAB Glomeasy RA106SLSFME, RA106GRPFME, RA300, RA300AIS e RA300DAB. Il cavo ha i connettori FME COSTAMPATI pre-installati su entrambe le terminazioni per un'installazione estremamente facile e rapida. Tale tipo di cavo coassiale è disponibile anche nelle seguenti lunghezze: 3m 6m 12m 18m 30m.

RA350/30FME

30 m (99') RG-8X low loss coaxial cable with pre-wired fme connectors - 50 OHMS - white

Category: Coax cables

Subcategory: 50 Ohm

Code: RA350/30FME



🇺🇸 RG8X low loss coaxial cable for Glomeasy VHF, AIS and DAB antennas: RA106SLSFME, RA106GRPFME, RA300, RA300AIS and RA300DAB. Long 30m (99'), has pre-installed FME connectors on both termination for a very easy and fast intallation. This type of coaxial cable is available also in other lenghts: 3m (10') 6m (20') 12m (39') 18m (59') 25m (82').

🇮🇹 RG8X câble coaxial à faible perte pour les antennes VHF, AIS et DAB Glomeasy. Long 30m, a les connecteur FME préinstallé dans les deux terminaisons pour un installation tres rapid et facile.Ce type de cable coaxial est disponible aussi avec autres different longueurs:- 3m- 6m- 12m- 18m- 25m.

🇮🇹 Cavo coassiale RG8X lungo 30m, a bassa perdita per le antenne VHF, AIS e DAB Glomeasy RA106SLSFME, RA106GRPFME, RA300, RA300AIS e RA300DAB. Il cavo ha i connettori FME COSTAMPATI pre-installati su entrambe le terminazioni per un'installazione estremamente facile e rapida. Tale tipo di cavo coassiale è disponibile anche nelle seguenti lunghezze: 3m 6m 12m 18m 25m.

RA360/6

6 m (20') RG-62 low loss coaxial cable with pre-wired fme and motorola connectors - 93 OHMS - black

Category: Coax cables

Subcategory: 93 Ohm

Code: RA360/6



🇺🇸 RG-62 low loss coaxial cable for Glomeasy FM antennas. Long 6 m (20'), has pre-installed FME and Motorola connector for a very easy and fast intallation. This type of coaxial cable is available also in other lenghts: 18m (59') 25m (82').

🇮🇹 RG-62 câble coaxial à faible perte pour les antennes Glomeasy FM. Long 6m, a les connecteur FME et Motorola préinstallé dans les deux terminaisons pour un installation tres rapid et facile. Ce type de cable coaxial est disponible aussi avec autres different longueurs:- 18m- 25m.

🇮🇹 Cavo coassiale RG62 lungo 6m, a bassa perdita per le antenne FM Glomeasy. Il cavo ha i connettori FME e MOTOROLA COSTAMPATI pre-installati per un'installazione estremamente facile e rapida. Tale tipo di cavo coassiale è disponibile anche nelle seguenti lunghezze: 18m 25m.



RA360/18

18 m (59') RG-62 low loss coaxial cable with pre-wired fme and motorola connectors - 93 OHMS - black

Category: Coax cables

Subcategory: 93 Ohm

Code: RA360/18



 RG-62 low loss coaxial cable for Glomeasy FM antennas. Long 18 m (59'), has pre-installed FME and Motorola connector for a very easy and fast intallation. This type of coaxial cable is available also in other lenghts: 6m (20') 25m (82').

 RG-62 câble coaxial à faible perte pour les antennes Glomeasy FM. Long 18m, a les connecteur FME et Motorola préinstallé dans les deux terminaisons pour un installation tres rapid et facile. Ce type de cable coaxial est disponible aussi avec autres different longueurs:- 6m- 25m.

 Cavo coassiale RG62 lungo 18m, a bassa perdita per le antenne FM Glomeasy. Il cavo ha i connettori FME e MOTOROLA COSTAMPATI pre-installati per un'installazione estremamente facile e rapida. Tale tipo di cavo coassiale è disponibile anche nelle seguenti lunghezze: 6m 25m.

RA360/25

25 m (82') RG-62 low loss coaxial cable with pre-wired fme and motorola connectors - 93 OHMS - black

Category: Coax cables

Subcategory: 93 Ohm

Code: RA360/25



🇬🇧 RG-62 low loss coaxial cable for Glomeasy FM antennas. Long 25 m (82'), has pre-installed FME and Motorola connector for a very easy and fast installation. This type of coaxial cable is available also in other lengths: 6m (20') 18m (59').

🇫🇷 RG-62 câble coaxial à faible perte pour les antennes Glomeasy FM. Long 25m, a les connecteur FME et Motorola préinstallé dans les deux terminaisons pour un installation tres rapid et facile. Ce type de cable coaxial est disponible aussi avec autres different longueurs: - 6m- 18m.

🇮🇹 Cavo coassiale RG62 lungo 25m, a bassa perdita per le antenne FM Glomeasy. Il cavo ha i connettori FME e MOTOROLA COSTAMPATI pre-installati per un'installazione estremamente facile e rapida. Tale tipo di cavo coassiale è disponibile anche nelle seguenti lunghezze: 6m 18m.



ZigBoat® Starter Kit

The 100% wireless remote system for monitoring and interacting with your boat via the free App. No monthly fees or subscriptions. This kit contains a Gateway, a Porthole/Door sensor, a Battery sensor, a Bilge Flood sensor, and long life batteries, up to 5 years, ensuring safety and peace of mind.

Category: ZigBoat

Subcategory: ZigBoat kits

Code: ZB101

🇬🇧 ZigBoat® is an innovative ZigBee/WiFi wireless system for monitoring and interacting with your boat either remotely or while on board ensuring safety and peace of mind with no monthly fees or subscription. The ZigBoat® consists of a core module (Gateway) and a series of standard and optional sensors that can be added to your specific needs. Thanks to ZigBee and Wi-Fi wireless technologies, which have direct communication with onboard sensors without the need for a cloud, ZigBoat® sends real-time push notifications when critical events occur. Using the ZigBoat® app, you can check boat information that is being monitored by the system.

This kit contains a Gateway, a Porthole/Door sensor, a Battery sensor, a Flood sensor, and batteries for sensors:

▶ **GATEWAY**

It is the core module of the ZigBoat® system. It's an open platform that can be integrated with unlimited ZigBoat® additional sensors and features. If connected to the internet, sends you push notifications on your mobile device.

▶ **PORTHOLE/DOOR SENSOR**

You will receive alerts in case of opening and closing on door and portholes on your boat.

▶ **BATTERY SENSOR**

Monitor battery voltage.

▶ **BILGE FLOOD SENSOR**

Be instantly informed if the boat is taking on water. Moreover, the Flood Alarm has a built-in siren that will sound when water is detected.

▶ **ZigBoat® is:EASY PLUG & PLAY**

ZigBoat® is easy to install and use. No cable needed. Just Plug & Play for wireless remote control & monitoring of your boat

▶ **LATEST GENERATION TECHNOLOGY**

Based on WiFi and ZigBee wireless technologies for fast and easy connection with the onboard sensors and managed by the ZigBoat™ iOS or Android App

▶ **SAFE AND RELIABLE**

The ZigBoat® gateway uses direct, encrypted and real-time Peer-to-Peer connection platform to communicate with your mobile devices (smartphone and tablet) and have boat control anytime and anywhere

▶ **FLEXIBLE, MODULAR AND EVOLVING**

ZigBoat® offers several sensors and features to meet your specific needs, quickly and easily manage and configure via the App. The system can be integrated and expanded with unlimited additional sensors

 ZigBoat® est un système sans fil innovant ZigBee / WiFi, sans cloud, pour surveiller et interagir avec votre bateau à distance ou à bord, assurant la sécurité et la tranquillité d'esprit sans frais mensuels ni abonnement. Le ZigBoat® se compose d'un module de base (Gateway) et d'une série de capteurs standard et optionnels qui peuvent être ajoutés à vos besoins spécifiques. Grâce aux technologies sans fil ZigBee et Wi-Fi, qui communiquent directement avec les capteurs embarqués sans nécessiter de cloud, ZigBoat® envoie des notifications push en temps réel lorsque des événements critiques se produisent. En utilisant l'application ZigBoat®, vous pouvez vérifier les informations sur le bateau surveillées par le système.

Ce kit contient une passerelle, un capteur de hublot / porte, un capteur de batterie, un capteur d'inondation et des batteries pour les capteurs:

► **PASSERELLE**

C'est le module de base du système ZigBoat®. C'est une plate-forme ouverte qui peut être intégrée avec des capteurs et fonctions supplémentaires ZigBoat® illimités. Si vous êtes connecté à Internet, vous envoyez des notifications push sur votre appareil mobile.

► **CAPTEUR DE PORTE / HUBLOT**

Vous recevrez des alertes en cas d'ouverture et de fermeture sur la porte et les hublots de votre bateau.

► **CAPTEUR DE BATTERIE**

Le capteur de batterie ZigBoat® surveille la tension de la batterie à 12V et 24V et, s'il tombe en dessous d'un niveau prédéfini, envoie des notifications push.

► **CAPTEUR D'INONDATION DE CALE**

Soyez immédiatement informé si le bateau prend de l'eau. En outre, l'alarme d'inondation a une sirène intégrée qui sonnera quand l'eau est détectée.

► **ZigBoat® est: PLUG & PLAY**

ZigBoat® est facile à installer et à utiliser. Aucun câble requis.

► **TECNOLOGIE DE DERNIÈRE GÉNÉRATION**

Basé sur les technologies sans fil WiFi et ZigBee pour une connexion rapide et facile avec les capteurs embarqués et géré par l'application iOS ou Android ZigBoat®

► **SÛR ET FIABLE**

La passerelle ZigBoat® utilise une plate-forme de connexion Peer-to-Peer directe, cryptée et en temps réel pour communiquer avec vos appareils mobiles (smartphone et tablette) et contrôler les bateaux à tout moment et en tout lieu.

► **FLEXIBLE, MODULAIRE ET ÉVOLUTIF**

ZigBoat® offre plusieurs capteurs et fonctionnalités pour répondre à vos besoins spécifiques. Le système peut être intégré et étendu avec des capteurs supplémentaires illimités

 ZigBoat® è un innovativo sistema wireless ZigBee / WiFi, senza cloud, per il monitoraggio e l'interazione con la tua barca sia da remoto che a bordo, garantendo sicurezza e tranquillità senza costi o abbonamenti mensili. ZigBoat™ è costituito da un modulo principale (Gateway) e una serie di sensori standard e opzionali che possono essere aggiunti alle tue esigenze specifiche. Grazie alle tecnologie wireless ZigBee e Wi-Fi, che hanno una comunicazione diretta con i sensori di bordo senza la necessità di un cloud, ZigBoat® invia notifiche push in tempo reale quando si verificano eventi critici. Utilizzando l'app ZigBoat®, è possibile controllare le informazioni dell'imbarcazione monitorate dal sistema.

Questo kit contiene un gateway, un sensore porta/oblò, un sensore batteria, un sensore acqua in sentina e batterie a lunga durata per sensori:

► **GATEWAY**

È il modulo principale del sistema ZigBoat®. È una piattaforma aperta che può essere integrata con illimitati sensori e funzionalità ZigBoat® aggiuntivi. Se connesso a Internet invia notifiche push sul tuo dispositivo mobile.

► **SENSORE PORTA/OBLÒ'**

Riceverai avvisi in caso di apertura e chiusura di porte e oblò della tua barca.

► **SENSORE BATTERIA**

Il sensore batteria ZigBoat® monitora la tensione della batteria sia a 12V sia a 24V e, se scende sotto un livello predefinito, invia notifiche push.

► **SENSORE ACQUA IN SENTINA**

Sarete immediatamente informati se la barca sta imbarcando acqua. Inoltre, l'allarme ha una sirena incorporata che suonerà quando viene rilevata l'acqua.

► **ZigBoat® è: PLUG & PLAY**

ZigBoat® è facile da installare e utilizzare. Nessun cavo necessario.

► **ULTIMA TECNOLOGIA DI GENERAZIONE**

Basato sulle tecnologie wireless WiFi e ZigBee per una connessione rapida e semplice con i sensori di bordo. Gestito dall'app ZigBoat® per i dispositivi iOS o Android

► **SICURO E AFFIDABILE**

Il gateway ZigBoat® utilizza la piattaforma di connessione Peer-to-Peer diretta, crittografata e in tempo reale per comunicare con i i dispositivi mobili (smartphone e tablet) e avere il controllo della barca sempre e ovunque nel rispetto della vostra privacy

► **FLESSIBILE, MODULARE ED EVOLUTIVO**

ZigBoat® offre diversi sensori e funzionalità per soddisfare le vostre esigenze. Il sistema può essere integrato e ampliato con sensori aggiuntivi illimitati



🇬🇧 ZigBoat® is an innovative ZigBee/WiFi wireless system for monitoring and interacting with your boat either remotely or while on board ensuring safety and peace of mind with no monthly fees or subscription. The ZigBoat® consists of a core module (Gateway) and a series of standard and optional sensors that can be added to your specific needs. Thanks to ZigBee and Wi-Fi wireless technologies, which have direct communication with onboard sensors without the need for a cloud, ZigBoat® sends real-time push notifications when critical events occur. Using the ZigBoat® app, you can check boat information that is being monitored by the system. With the supplied 4G device (ZigBoat 4G Link), you can receive also SMS notification in case of a critical event occurs.

This kit contains a Gateway, a 4G device, a Battery sensor, a Flood sensor, and batteries for sensors:

► GATEWAY

It is the core module of the ZigBoat® system. It's an open platform that can be integrated with unlimited ZigBoat® additional sensors and features. If connected to the internet, sends you push notifications on your mobile device. or a local WiFi), sends you push notifications on your mobile device.

► 5G ZIGBOAT LINK

4G device to connect to internet your ZigBoat® monitoring system using a 4G connection. Using ZigBoat® 4G Link (Sim Card not included) you can check boat information that is being monitored by the system wherever and whenever you are, receive push notifications on your ZigBoat® App and SMS notifications.

ZigBoat® Connectivity 4G kit

The 100% wireless remote system for monitoring and interacting with your boat via the free App without monthly fees or subscriptions. This ZigBoat® kit allows you to receive SMS notifications and to connect the ZigBoat gateway to the internet for push notifications on your ZigBoat® App (SIM Card not included). This kit contains a Gateway, a 4G device, a Battery sensor, a Bilge Flood sensor, and long life batteries, up to 5 years, ensuring safety and peace of mind.

Category: ZigBoat

Subcategory: ZigBoat kits

Code: ZB104G

► BATTERY SENSOR

Monitor battery voltage.

► BILGE FLOOD SENSOR

Be instantly informed if the boat is taking on water. Moreover, the Flood Alarm has a built-in siren that will sound when water is detected.

► ZigBoat® is: EASY PLUG & PLAY

ZigBoat® is easy to install and use. No cable needed. Just Plug & Play for wireless remote control & monitoring of your boat

► LATEST GENERATION TECHNOLOGY

Based on WiFi and ZigBee wireless technologies for fast and easy connection with the onboard sensors and managed by the ZigBoat® iOS or Android App

► SAFE AND RELIABLE

The ZigBoat® gateway uses direct, encrypted and real-time Peer-to-Peer connection platform to communicate with your mobile devices (smartphone and tablet) and have boat control anytime and anywhere

► FLEXIBLE, MODULAR AND EVOLVING

ZigBoat® offers several sensors and features to meet your specific needs, quickly and easily manage and configure via the App. The system can be integrated and expanded with unlimited additional sensors

Le système à distance 100% sans fil pour surveiller et interagir avec votre bateau via l'application gratuite. Pas de frais mensuels ou d'abonnements. Ce kit contient une passerelle, un capteur de hublot / porte, un capteur de batterie, un capteur de crevaisson et des batteries longue durée, jusqu'à 4 ans, assurant sécurité et tranquillité d'esprit.

ZigBoat® est un système sans fil innovant ZigBee / WiFi, sans cloud, pour surveiller et interagir avec votre bateau à distance

- ▶ ou à bord, assurant la sécurité et la tranquillité d'esprit sans frais mensuels ni abonnement. Le ZigBoat® se compose d'un module de base (Gateway) et d'une série de capteurs standard et optionnels qui peuvent être ajoutés à vos besoins spécifiques. Grâce aux technologies sans fil ZigBee et Wi-Fi, qui communiquent directement avec les capteurs embarqués
- ▶ sans nécessiter de cloud, ZigBoat® envoie des notifications push en temps réel lorsque des événements critiques se produisent. En utilisant l'application ZigBoat®, vous pouvez vérifier les informations sur le bateau surveillées par le système. Avec l'Appareil ZigBoat® 4G Link vous pouvez également recevoir une notification par SMS en cas d'événement critique.

Ce kit contient un gateway, l'Appareil ZigBoat® 4G Link, un capteur de batterie, un capteur d'inondation et des batteries pour les capteurs:

GATEWAY

C'est le module de base du système ZigBoat®. C'est une plate-forme ouverte qui peut être intégrée avec des capteurs et fonctions supplémentaires ZigBoat® illimités. Si vous êtes connecté à Internet, vous envoyez des notifications push sur votre appareil mobile.

ZIGBOAT® 4G LINK

Appareil 4G pour connecter à Internet votre système de surveillance ZigBoat® à l'aide d'une connexion 4G, pour recevoir des SMS et des notifications push (carte Sim non incluse).

CAPTEUR DE BATTERIE

Le capteur de batterie ZigBoat® surveille la tension de la batterie à 12V et 24V et, s'il tombe en dessous d'un niveau prédéfini, envoie des notifications push.

CAPTEUR D'INONDATION DE CALE

Soyez immédiatement informé si le bateau prend de l'eau. En outre, l'alarme d'inondation a une sirène intégrée qui sonnera quand l'eau est détectée.

ZigBoat® est:

PLUG & PLAY

ZigBoat® est facile à installer et à utiliser. Aucun câble requis.

TECNOLOGIE DE DERNIÈRE GÉNÉRATION

Basé sur les technologies sans fil WiFi et ZigBee pour une connexion rapide et facile avec les capteurs embarqués et géré par l'application iOS ou Android ZigBoat®

SÛR ET FIABLE

La passerelle ZigBoat® utilise une plate-forme de connexion Peer-to-Peer directe, cryptée et en temps réel pour communiquer avec vos appareils mobiles (smartphone et tablette) et contrôler les bateaux à tout moment et en tout lieu.

FLEXIBLE, MODULAIRE ET ÉVOLUTIF

ZigBoat® offre plusieurs capteurs et fonctionnalités pour répondre à vos besoins spécifique. Le système peut être intégré et étendu avec des capteurs supplémentaires illimités

ZigBoat® est un innovativo sistema wireless ZigBee / WiFi, senza cloud, per il monitoraggio e l'interazione con la tua barca sia da remoto che a bordo, garantendo sicurezza e tranquillità senza costi o abbonamenti mensili. ZigBoat® è costituito da un modulo principale (Gateway) e una serie di sensori standard e opzionali che possono essere aggiunti alle tue esigenze specifiche. Grazie alle tecnologie wireless ZigBee e Wi-Fi, che hanno una comunicazione diretta con i sensori di bordo senza la necessità di un cloud, ZigBoat® invia notifiche push in tempo reale quando si verificano eventi critici. Utilizzando l'app ZigBoat®, è possibile controllare le informazioni dell'imbarcazione monitorate dal sistema.

Questo kit contiene un gateway, un sensore batteria, un sensore acqua in sentina, il device 4G e batterie a lunga durata per sensori:

▶ **GATEWAY**

È il modulo principale del sistema ZigBoat. È una piattaforma aperta che può essere integrata con illimitati sensori e funzionalità ZigBoat aggiuntivi. Se connesso a Internet, invia notifiche push sul tuo dispositivo mobile.

▶ **ZIGBOAT 4G LINK**

Dispositivo 4G per collegare ad internet il gateway dello ZigBoat®, ricevere notifiche push e SMS (scheda SIM non inclusa).

▶ **SENSORE BATTERIA**

Il sensore batteria ZigBoat® monitora la tensione della batteria sia a 12V sia a 24V e, se scende sotto un livello predefinito, invia notifiche push.

▶ **SENSORE ACQUA IN SENTINA**

Sarete immediatamente informati se la barca sta imbarcando acqua. Inoltre, l'allarme ha una sirena incorporata che suonerà quando viene rilevata l'acqua.

▶ **ZigBoat® è: PLUG & PLAY**

ZigBoat® è facile da installare e utilizzare. Nessun cavo necessario.

▶ **ULTIMA TECNOLOGIA DI GENERAZIONE**

Basato sulle tecnologie wireless WiFi e ZigBee per una connessione rapida e semplice con i sensori di bordo. Gestito dall'app ZigBoat® per i dispositivi iOS o Android

▶ **SICURO E AFFIDABILE**

Il gateway ZigBoat® utilizza la piattaforma di connessione Peer-to-Peer diretta, crittografata e in tempo reale per comunicare con i dispositivi mobili (smartphone e tablet) e avere il controllo della barca sempre e ovunque nel rispetto della vostra privacy

▶ **FLESSIBILE, MODULARE ED EVOLUTIVO**

ZigBoat® offre diversi sensori e funzionalità per soddisfare le vostre esigenze. Il sistema può essere integrato e ampliato con sensori aggiuntivi illimitati



🇬🇧 ZigBoat® is an innovative ZigBee/WiFi wireless system for monitoring and interacting with your boat either remotely or while on board ensuring safety and peace of mind with no monthly fees or subscription. The ZigBoat® consists of a core module (Gateway) and a series of standard and optional sensors that can be added to your specific needs. Thanks to ZigBee and Wi-Fi wireless technologies, which have direct communication with onboard sensors without the need for a cloud, ZigBoat® sends real-time push notifications when critical events occur. Using the ZigBoat® app, you can check boat information that is being monitored by the system. With the supplied 5G device (ZigBoat 5G Link), you can receive also SMS notification in case of a critical event occurs.

This kit contains a Gateway, a 5G device, a Battery sensor, a Flood sensor, and batteries for sensors:

► GATEWAY

It is the core module of the ZigBoat® system. It's an open platform that can be integrated with unlimited ZigBoat® additional sensors and features. If connected to the internet, sends you push notifications on your mobile device. or a local WiFi), sends you push notifications on your mobile device.

► 5G ZIGBOAT LINK

5G device to connect to internet your ZigBoat® monitoring system using a 5G connection. Using ZigBoat® 5G Link (Sim Card not included) you can check boat information that is being monitored by the system wherever and whenever you are, receive push notifications on your ZigBoat® App and SMS notifications.

ZigBoat® Connectivity 5G Kit

The 100% wireless remote system for monitoring and interacting with your boat via the free App without monthly fees or subscriptions. This ZigBoat® kit allows you to receive SMS notifications and to connect the ZigBoat gateway to the internet for push notifications on your ZigBoat® App (SIM Card not included). This kit contains a Gateway, a 5G device, a Battery sensor, a Bilge Flood sensor, and long life batteries, up to 5 years, ensuring safety and peace of mind.

Category: ZigBoat

Subcategory: ZigBoat kits

Code: ZB105G

► BATTERY SENSOR

Monitor battery voltage.

► BILGE FLOOD SENSOR

Be instantly informed if the boat is taking on water. Moreover, the Flood Alarm has a built-in siren that will sound when water is detected.

► ZigBoat® is: EASY PLUG & PLAY

ZigBoat® is easy to install and use. No cable needed. Just Plug & Play for wireless remote control & monitoring of your boat

► LATEST GENERATION TECHNOLOGY

Based on WiFi and ZigBee wireless technologies for fast and easy connection with the onboard sensors and managed by the ZigBoat® iOS or Android App

► SAFE AND RELIABLE

The ZigBoat® gateway uses direct, encrypted and real-time Peer-to-Peer connection platform to communicate with your mobile devices (smartphone and tablet) and have boat control anytime and anywhere

► FLEXIBLE, MODULAR AND EVOLVING

ZigBoat® offers several sensors and features to meet your specific needs, quickly and easily manage and configure via the App. The system can be integrated and expanded with unlimited additional sensors

Le système à distance 100% sans fil pour surveiller et interagir avec votre bateau via l'application gratuite. Pas de frais mensuels ou d'abonnements. Ce kit contient une passerelle, un capteur de hublot / porte, un capteur de batterie, un capteur de crevaisson et des batteries longue durée, jusqu'à 5 ans, assurant sécurité et tranquillité d'esprit.

ZigBoat® est un système sans fil innovant ZigBee / WiFi, sans cloud, pour surveiller et interagir avec votre bateau à distance

- ▶ ou à bord, assurant la sécurité et la tranquillité d'esprit sans frais mensuels ni abonnement. Le ZigBoat® se compose d'un module de base (Gateway) et d'une série de capteurs standard et optionnels qui peuvent être ajoutés à vos besoins spécifiques. Grâce aux technologies sans fil ZigBee et Wi-Fi, qui communiquent directement avec les capteurs embarqués
- ▶ sans nécessiter de cloud, ZigBoat® envoie des notifications push en temps réel lorsque des événements critiques se produisent. En utilisant l'application ZigBoat®, vous pouvez vérifier les informations sur le bateau surveillées par le système. Avec l'Appareil ZigBoat® 5G Link vous pouvez également recevoir une notification par SMS en cas d'événement critique.

Ce kit contient un gateway, l'Appareil ZigBoat® 5G Link, un capteur de batterie, un capteur d'inondation et des batteries pour les capteurs:

GATEWAY

C'est le module de base du système ZigBoat®. C'est une plate-forme ouverte qui peut être intégrée avec des capteurs et fonctions supplémentaires ZigBoat® illimités. Si vous êtes connecté à Internet, vous envoyez des notifications push sur votre appareil mobile.

ZIGBOAT® 5G LINK

Appareil 5G pour connecter à Internet votre système de surveillance ZigBoat® à l'aide d'une connexion 5G, pour recevoir des SMS et des notifications push (carte Sim non incluse).

CAPTEUR DE BATTERIE

Le capteur de batterie ZigBoat® surveille la tension de la batterie à 12V et 24V et, s'il tombe en dessous d'un niveau prédéfini, envoie des notifications push.

CAPTEUR D'INONDATION DE CALE

Soyez immédiatement informé si le bateau prend de l'eau. En outre, l'alarme d'inondation a une sirène intégrée qui sonnera quand l'eau est détectée.

ZigBoat® est:

PLUG & PLAY

ZigBoat® est facile à installer et à utiliser. Aucun câble requis.

TECHNOLOGIE DE DERNIÈRE GÉNÉRATION

Basé sur les technologies sans fil WiFi et ZigBee pour une connexion rapide et facile avec les capteurs embarqués et géré par l'application iOS ou Android ZigBoat®

SÛR ET FIABLE

La passerelle ZigBoat® utilise une plate-forme de connexion Peer-to-Peer directe, cryptée et en temps réel pour communiquer avec vos appareils mobiles (smartphone et tablette) et contrôler les bateaux à tout moment et en tout lieu.

FLEXIBLE, MODULAIRE ET ÉVOLUTIF

ZigBoat® offre plusieurs capteurs et fonctionnalités pour répondre à vos besoins spécifique. Le système peut être intégré et étendu avec des capteurs supplémentaires illimités

ZigBoat® est un innovativo sistema wireless ZigBee / WiFi, senza cloud, per il monitoraggio e l'interazione con la tua barca sia da remoto che a bordo, garantendo sicurezza e tranquillità senza costi o abbonamenti mensili. ZigBoat® è costituito da un modulo principale (Gateway) e una serie di sensori standard e opzionali che possono essere aggiunti alle tue esigenze specifiche. Grazie alle tecnologie wireless ZigBee e Wi-Fi, che hanno una comunicazione diretta con i sensori di bordo senza la necessità di un cloud, ZigBoat® invia notifiche push in tempo reale quando si verificano eventi critici. Utilizzando l'app ZigBoat®, è possibile controllare le informazioni dell'imbarcazione monitorate dal sistema.

Questo kit contiene un gateway, un sensore batteria, un sensore acqua in sentina, il device 4G e batterie a lunga durata per sensori:

▶ **GATEWAY**

È il modulo principale del sistema ZigBoat. È una piattaforma aperta che può essere integrata con illimitati sensori e funzionalità ZigBoat aggiuntivi. Se connesso a Internet, invia notifiche push sul tuo dispositivo mobile.

▶ **ZIGBOAT 5G LINK**

Dispositivo 5G per collegare ad internet il gateway dello ZigBoat®, ricevere notifiche push e SMS (scheda SIM non inclusa).

▶ **SENSORE BATTERIA**

Il sensore batteria ZigBoat® monitora la tensione della batteria sia a 12V sia a 24V e, se scende sotto un livello predefinito, invia notifiche push.

▶ **SENSORE ACQUA IN SENTINA**

Sarete immediatamente informati se la barca sta imbarcando acqua. Inoltre, l'allarme ha una sirena incorporata che suonerà quando viene rilevata l'acqua.

▶ **ZigBoat® è: PLUG & PLAY**

ZigBoat® è facile da installare e utilizzare. Nessun cavo necessario.

▶ **ULTIMA TECNOLOGIA DI GENERAZIONE**

Basato sulle tecnologie wireless WiFi e ZigBee per una connessione rapida e semplice con i sensori di bordo. Gestito dall'app ZigBoat® per i dispositivi iOS o Android

▶ **SICURO E AFFIDABILE**

Il gateway ZigBoat® utilizza la piattaforma di connessione Peer-to-Peer diretta, crittografata e in tempo reale per comunicare con i dispositivi mobili (smartphone e tablet) e avere il controllo della barca sempre e ovunque nel rispetto della vostra privacy

▶ **FLESSIBILE, MODULARE ED EVOLUTIVO**

ZigBoat® offre diversi sensori e funzionalità per soddisfare le vostre esigenze. Il sistema può essere integrato e ampliato con sensori aggiuntivi illimitati



Gateway

Category: ZigBoat

Subcategory: ZigBoat sensors

Code: ZB100

🇬🇧 It's the core module of the ZigBoat® system. Allows the sensors to send push notifications when an event occurs. It's an open platform that can be integrated with unlimited ZigBoat® additional sensors and features.

🇫🇷 C'est le module de base du système ZigBoat®. C'est une plate-forme ouverte qui peut être intégrée avec des capteurs et fonctions supplémentaires ZigBoat® illimités. Si vous êtes connecté à Internet, vous envoyez des notifications push sur votre appareil mobile.

🇮🇹 È il modulo principale del sistema ZigBoat®. È una piattaforma aperta che può essere integrata con illimitati sensori e funzionalità ZigBoat® aggiuntivi. Se connesso a Internet, invia notifiche push sul tuo dispositivo mobile.



Battery sensor

Category: ZigBoat

Subcategory: ZigBoat sensors

Code: ZB201

🇬🇧 Battery Sensor monitors the battery power bank voltage and, if it drops below 11.8V sends you push notifications.

🇫🇷 Le capteur de batterie surveille la tension de la batterie à 12V et 24V et, s'il tombe en dessous d'un niveau prédéfini, envoie des notifications push.

🇮🇹 Il sensore batteria monitora la tensione della batteria sia a 12V sia a 24V e, se scende sotto un livello predefinito, invia notifiche push.

Bilge Flood sensor

Category: ZigBoat

Subcategory: ZigBoat sensors

Code: ZB202

🇺🇸 The ZigBoat® Bilge Flood Sensor instantly informs you if the boat is taking on water. Moreover, it has a built-in siren that will sound an alarm when water is detected.

🇫🇷 Soyez immédiatement informé si le bateau prend de l'eau. En outre, l'alarme d'inondation a une sirène intégrée qui sonnera quand l'eau est détectée.



🇮🇹 Sarete immediatamente informati se la barca sta imbarcando acqua. Inoltre, l'allarme ha una sirena incorporata che suonerà quando viene rilevata l'acqua.

Heat Alarm sensor

Category: ZigBoat

Subcategory: ZigBoat sensors

Code: ZB203

🇺🇸 Detects both rapid heat rise and absolute heat levels, and alerts you if a critical event occurs.

🇫🇷 Le capteur d'alarme de chaleur détecte les niveaux d'échauffement rapide et de chaleur absolue et vous avertit en cas d'événement critique.



🇮🇹 Il sensore di allarme calore rileva sia l'aumento rapido ed improvviso della temperatura sia i livelli di calore assoluti e avvisa l'utente in caso di eventi critici.



Smoke Alarm sensor

Category: ZigBoat

Subcategory: ZigBoat sensors

Code: ZB204

🇺🇸 You will be instantly notified of smoke detection fire through an internet-connected gateway. Moreover, the Smoke Alarm Sensor will warn occupants about smoke, using a loud siren.

🇫🇷 Vous serez instantanément averti de la détection de fumée via votre passerelle ZigBoat® connectée à Internet. De plus, le détecteur de fumée avertira les occupants de la présence de fumée à l'aide d'une sirène puissante.

🇮🇹 Sarai immediatamente avisato del rilevamento di fumo attraverso il gateway ZigBoat® connesso a Internet. Inoltre, il sensore di allarme fumo avviserà gli occupanti della presenza di fumo, utilizzando una sirena rumorosa.



Porthole/Door sensor

Category: ZigBoat

Subcategory: ZigBoat sensors

Code: ZB205

🇺🇸 Detects and reports opening and closing of doors and portholes.

🇫🇷 Vous recevrez des alertes en cas d'ouverture et de fermeture sur la porte et les hublots de votre bateau.

🇮🇹 Riceverai avvisi in caso di apertura e chiusura di porte e oblò della tua barca.

Motion sensor

Category: ZigBoat

Subcategory: ZigBoat sensors

Code: ZB206

🇺🇸 Detects movements on your boat and immediately communicates it to your mobile device.

🇫🇷 Il détecte les mouvements de votre bateau et le communique immédiatement à votre appareil mobile.



🇮🇹 Rileva i movimenti sulla tua barca e la comunica immediatamente al tuo dispositivo mobile.

Smart plug

Category: ZigBoat

Subcategory: ZigBoat sensors

Code: ZB207

🇺🇸 Allows you to instantly switch on and off electrical devices remotely.

🇫🇷 Vous permet d'allumer et d'éteindre instantanément des appareils électriques à distance.



🇮🇹 Consente di accendere e spegnere immediatamente i dispositivi elettrici da remoto.



Vous permet d'allumer et d'éteindre instantanément l'alimentation à quai (ou d'autres sources d'alimentation) à distance – 30A, 220 Vdc

Shore Power sensor

Category: ZigBoat

Subcategory: ZigBoat sensors

Code: ZB209

Allows you to instantly switch on and off the shore power (or other power sources) remotely – 30A, 220 Vdc

Consente di accendere e spegnere istantaneamente l'alimentazione da terra (o altre fonti di alimentazione) da remoto – 30 A, 220 Vdc



The only wireless ZigBee® GPS in the market. Tracks boat location and movement and sends you push notifications when the boat is out of the set geofence area without subscriptions, neither monthly fees, neither cloud. It includes many essential features for monitoring your boat and for your peace of mind, such as:

► GEOFENCING

Tracks your boat location and send alarms when it's out of the set geofence area

► FLEET TRACKING

Tracks your boat/fleet movement. Detailed route and speed history

► ANCHOR WATCH ALARM

GPS positioning sends alarms if your anchor starts to drag

ZigBee® GPS/Tracking

Category: ZigBoat

Subcategory: ZigBoat sensors

Code: ZB211

► WEATHER FORECASTS

Current daily weather forecasts

Technical specifications

1. **Color:** White
2. **Dimensions:** 100mm (4") Ø / Height: 58mm (2.3") GPS unit + 72mm (2.7") mount
3. **Weight:** 180 gr (0.4 lb)
4. **GPS Rx frequency:** L1 (1575.42 MHz)
5. **Power supply:** 12/24 V DC
6. **Power consumption:** Max 0.8 W, Typical 0.2 W
7. **Connectivity** IEEE 802.15.4 / ZigBee (2.4 GHz)
8. **Output power:** up to 20 dBm
9. **GPS:** up to 3 GNSS (GPS, Galileo, GLONASS, BeiDou)
10. **Operating temperature:** -25°C to +55°C
11. **Distance:** accuracy: < 10 m (in condition of clear view of the sky)

🇫🇷 Le seul GPS ZigBee® sans fil du marché. Suit l'emplacement et le mouvement du bateau. Envoie des alarmes lorsque le bateau est hors de la zone de geofencing définie. Le positionnement GPS permet de détecter si votre ancre commence à glisser. En outre, affiche à la fois les prévisions météorologiques quotidiennes actuelles.

Le GPS sans fil innovant ZigBee® présente les caractéristiques essentielles suivantes:

► **GEOFENCING**

Il garde une trace de votre bateau et envoie une notification quand il est en dehors de la plage définie.

► **SUIVI DE LA FLOTTE**

Il assure le suivi de votre flotte en utilisant une connexion directe, cryptée et en temps réel pour garantir la confidentialité et la sécurité à 100%.

► **CONTRÔLE D'ANCRAGE**

Le positionnement GPS vous permet d'être alerté si l'ancre est toujours.

► **PRÉVISIONS MÉTÉOROLOGIQUES**

Prévisions météorologiques quotidiennes en temps réel

Spécifications techniques

1. **Couleur:** blanc
2. **Dimensions:** 100 mm Ø / Hauteur: 58 mm GPS + 72 mm de montage
3. **Poids:** 180 gr
4. **Fréquence de réception GPS:** L1 (1575,42 MHz)
5. **Alimentation:** 12/24 V DC
6. **Consommation électrique:** maximum 0,8 W, typique 0,2 W
7. **Connectivité** IEEE 802.15.4 / ZigBee® (2,4 GHz)
8. **Puissance de sortie:** jusqu'à 20 dBm
9. **GPS:** jusqu'à 3 GNSS (GPS, Galileo, GLONASS, BeiDou)
10. **Température de fonctionnement:** -25 ° C à + 55 ° C
11. **Distance: précision:** <10 m (en condition de vue dégagée du ciel)

🇮🇹 L'unico GPS wireless ZigBee® nel mercato. Rileva la posizione e i movimenti della barca e invia notifiche push qualora la barca esca da un'area di geofence pre-impostata, senza abbonamenti, né costi mensili, né cloud.

Include caratteristiche essenziali per monitorare la barca e garantirvi la più completa tranquillità e sicurezza, quali:

► **GEOFENCING**

Tiene traccia della tua barca e invia una notifica quando è fuori dalla portata impostata.

► **FLEET TRACKING**

Tiene traccia della tua flotta utilizzando una connessione diretta, crittografata e in tempo reale per garantire il 100% di privacy e sicurezza.

► **CONTROLLO DELL'ANCORA**

Il posizionamento GPS permette di avvisarvi se l'ancora ara.

► **PREVISIONI METEO**

Previsioni meteo giornaliere in tempo reale

Specifiche tecniche

1. **Colore:** Bianco
2. **Dimensioni:** 100mm Ø / Altezza: unità GPS 58mm + base da 72mm
3. **Peso:** 180 gr
4. **Frequenza GPS Rx:** L1 (1575.42 MHz)
5. **Alimentazione:** 12/24 V DC
6. **Consumo:** Max 0.8 W, Typical 0.2 W
7. **Connettività:** IEEE 802.15.4 / ZigBee (2.4 GHz)
8. **Potenza di uscita:** fino a 20 dBm
9. **GPS:** fino a 3 GNSS (GPS, Galileo, GLONASS, BeiDou)
10. **Temperatura di esercizio:** -25°C to +55°C
11. **Precisione della distanza:** < 10 m (in condizioni di cielo limpido)



ZigBoat® 4G Link

Category: ZigBoat

Subcategory: ZigBoat sensors

Code: ZB212

🇬🇧 Monitor your boat wherever and whenever you are! ZigBoat® 4G Link (code ZB212) is the new 4G device to connect to internet your ZigBoat® monitoring system using a 4G connection.

Using ZigBoat® 4G Link (Sim Card not included) you can check boat information that is being monitored by the system wherever and whenever you are, receive push notifications on your ZigBoat® App and SMS notifications.

Moreover, ZigBoat® system uses direct, encrypted and real-time peer-to-peer connection platform to communicate with your mobile devices (smartphone and tablet) ensuring 100% privacy with no cloud neither subscription.

🇫🇷 ZigBoat® 4G Link (code ZB212) est le nouvel appareil 4G pour connecter à Internet votre système de surveillance ZigBoat® à l'aide d'une connexion 4G.

En utilisant ZigBoat® 4G Link (carte Sim non incluse), vous pouvez vérifier les informations du bateau qui sont surveillées par le système où et quand vous êtes, recevoir des notifications push sur votre application ZigBoat® et des notifications par SMS.

De plus, le système ZigBoat® utilise une plate-forme de connexion peer-to-peer directe, cryptée et en temps réel pour communiquer avec vos appareils mobiles (smartphone et tablette) en garantissant une confidentialité à 100% sans cloud ni abonnement.

🇮🇹 ZigBoat® 4G Link (codice ZB212) è il nuovo dispositivo 4G per connettere ad internet il tuo sistema di monitoraggio ZigBoat® utilizzando una connessione 4G.

Utilizzando ZigBoat® 4G Link (Sim Card non inclusa) puoi controllare le informazioni sulla barca monitorate dal sistema ovunque e in qualsiasi momento, ricevere notifiche push sulla tua App ZigBoat® e notifiche SMS.

Inoltre, il sistema ZigBoat® utilizza una piattaforma di connessione peer-to-peer diretta, crittografata e in tempo reale per comunicare con i tuoi dispositivi mobili (smartphone e tablet) garantendo il 100% di privacy senza cloud né abbonamento.



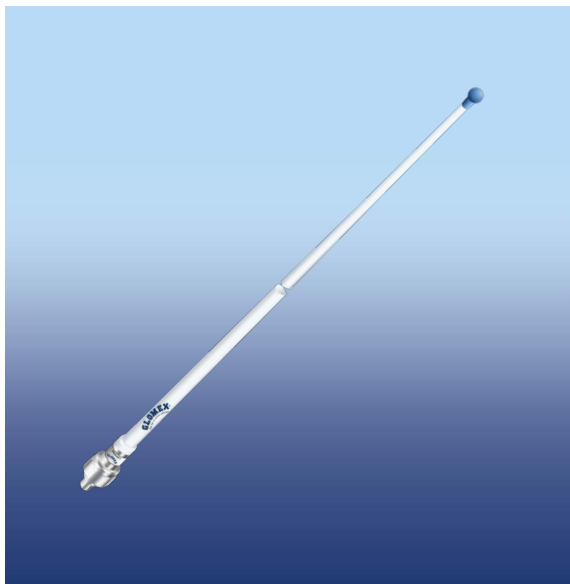

PRA451B

1,2 m (4') 2.1dBi VHF professional antenna

Category: VHF

Subcategory: SO239 terminantion

Code: PRA451B



🇮🇹 2.1 dBi gain antenna. Vertically polarized, vibration proof, lightweight, corrosion resistant antenna. The antenna brass elements are protected by high quality and rugged tapered fibreglass tube. Developed with appropriate materials for withstanding harsh marine environmental conditions.

Easy mounting using 1" BSP mounts (not included). Designed for a wide variety of installation with thanks to the two optional termination: SO239.

Each antenna metal element is DC-grounded for reducing the noise caused by atmospheric discharge. Wide bandwidth with respect to SWR and gain It can be also a base station antenna.

FREQUENCY RANGE	156/162
GAIN	2.1dBi
NOMINAL IMPEDANCE	50 ohms
POLARIZATION	Vertical
VSWR	≤ 1,3 at 156,8 MHz
POWER RATING	100 W
DC GROUND	Yes
TERMINATION	SO239
LENGHT	1,2m/4'
WEIGHT	439g/15,17oz
INSTALLATION	1" BSP x tpi
TEMPERATURE RANGE	-40 / +60 °C
WIND RATING	60 m/s
COLOUR	white
MATERIAL	Fibreglass

More info on www.glomex.it

Gain 2 dBi. Antenne avec une polarisation verticale, résistante aux sollicitations, légère, résistante à la corrosion.

Les éléments en Otton de l'antenne sont protégés par une robuste fibre de verre et de haute qualité. Fabriquée avec des matériaux appropriés pour soutenir l'environnement marin. Montage facile en utilisant des supports 1 "GAZ (non inclus).

Terminaison SO2239. Chaque élément métallique de l'antenne est en DC-GROUND. Peut être aussi une antenne pour station terre

PUNTI CHIAVE: 2.1 dBi di guadagno. Antenna con polarizzazione verticale, resistente alle sollecitazioni, leggera, resistente alla corrosione.

Gli elementi in ottone dell'antenna sono protetti da una canna in fibra di vetro robusta e di alta qualità. Realizzata con materiali appropriati per sostenere le dure condizioni ambientali marine. Facilità di montaggio usando supporti 1"GAS (non inclusi).

Terminazione: SO239. Ogni elemento in metallo dell'antenna è DC-ground. Può essere anche un'antenna per stazioni di terra.

OPTIONAL ACCESSORIES



▲ PRM180 Electropolished AISI316 stainless steel deck mount



▲ PRM298 Electropolished AISI316 stainless steel pipe mounting bracket for vertical or horizontal mounting for tubes from 25 mm (1") to 80 mm (3")

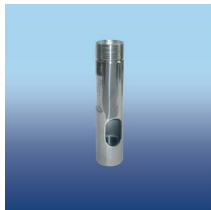

▲ PRM280 Electropolished AISI316 stainless adaptor 1" BSP x 11 tpi male to 1"x14 UNS female, with slot for cable



▲ PRM162 Electropolished stainless steel masthead bracket with 1"x14 nut and washer



▲ RA118 100 m (328') RG-213/U MIL C17 white coax cable

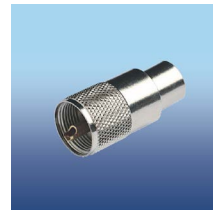

▲ RA131 PL-259 male connector for RG213/U cable (vhf)

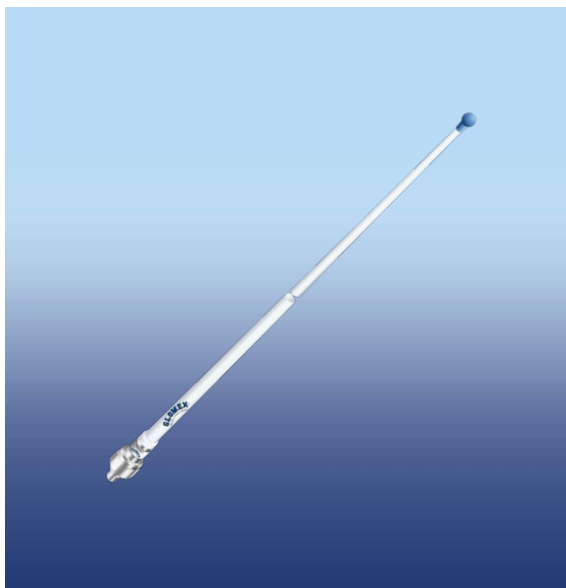

PRA452B

1,63 m (5.4') 2.1 dBi VHF professional antenna

Category: VHF

Subcategory: SO239 termination

Code: PRA452B



🇮🇹 2.1 dBi gain antenna. Vertically polarized, vibration proof, lightweight, corrosion resistant antenna. The antenna brass elements are protected by high quality and rugged tapered fibreglass tube. Developed with appropriate materials for withstanding harsh marine environmental conditions.

Easy mounting using 1" BSP mounts (not included). Designed for a wide variety of installation. Termination: SO239. Each antenna metal element is DC-grounded for reducing the noise caused by atmospheric discharge.

Wide bandwidth with respect to SWR and gain. It can be also a base station antenna.

FREQUENCY RANGE	156/162
GAIN	2.1dBi
NOMINAL IMPEDANCE	50 ohms
POLARIZATION	Vertical
VSWR	≤ 1,3 at 156,8 MHz
POWER RATING	100 W
DC GROUND	Yes
TERMINATION	SO239
LENGHT	1,63 / 5.35'
WEIGHT	504g / 17.8oz
INSTALLATION	1" BSP x tpi
TEMPERATURE RANGE	-40 / +60 °C
WIND RATING	60 m/s
COLOUR	white
MATERIAL	Fibreglass
<i>More info on www.glomex.it</i>	

Gain 2,1 dBi. Antenne polarisée verticalement, résistante aux vibrations, légère et résistante à la corrosion. Les éléments en laiton de l'antenne sont protégés par un tube en fibre de verre conique robuste et de haute qualité. Développé avec des matériaux appropriés pour résister aux conditions environnementales marines difficiles.

Montage facile à l'aide de supports BSP 1" (non inclus). Conçu pour une grande variété d'installations. Terminaison : SO239. Chaque élément métallique d'antenne est mis à la terre en courant continu pour réduire le bruit causé par la décharge atmosphérique. Large bande passante par rapport au ROS et au gain. Il peut également s'agir d'une antenne de station de base

PUNTI CHIAVE: 2.1 dBi di guadagno. Antenna con polarizzazione verticale, resistente alle sollecitazioni, leggera, resistente alla corrosione. Gli elementi in ottone dell'antenna sono protetti da una canna in fibra di vetro robusta e di alta qualità. Realizzata con materiali appropriati per sostenere le dure condizioni ambientali marine.

Facilità di montaggio usando supporti 1" GAS (non inclusi). Sviluppata per una ampia varietà di installazione. Terminazioni opzionali: SO239. Ogni elemento in metallo dell'antenna è DC-ground. Può essere anche un'antenna per stazioni di terra.

OPTIONAL ACCESSORIES



▲ PRM180 Electropolished AISI316 stainless steel deck mount



▲ PRM298 Electropolished AISI316 stainless steel pipe mounting bracket for vertical or horizontal mounting for tubes from 25 mm (1") to 80 mm (3")

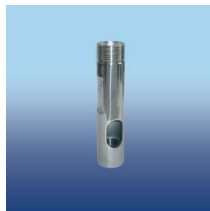

▲ PRM280 Electropolished AISI316 stainless adaptor 1" BSP x 11 tpi male to 1" x14 UNS female, with slot for cable



▲ RA118 100 m (328') RG-213/U MIL C17 white coax cable



PRA461A

2,7 m (8.9') 5.1 dBi VHF professional antenna

Category: VHF

Subcategory: N female termination

Code: PRA461A

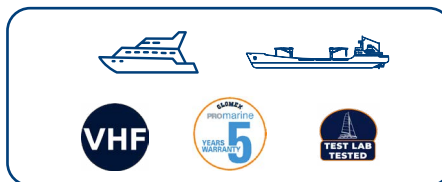

5.1 dBi gain antenna. Collinear coaxial omnidirectional dipole antenna. Vertically polarized, vibration proof, lightweight, corrosion resistant antenna. The antenna brass elements are protected by high quality and rugged tapered fibreglass tube.

Developed with appropriate materials for withstanding harsh marine environmental conditions. Easy mounting using 1" BSP mounts (not included). Designed for a wide variety of installation. Termination: N female. Each antenna metal element is DC-grounded for reducing the noise caused by atmospheric discharge. Wide bandwidth with respect to SWR and gain. It can be also a base station antenna.

Gain 5,1 dBi. Antenne dipôle omnidirectionnelle coaxiale colinéaire. Antenne polarisée verticalement, résistante aux vibrations, légère et résistante à la corrosion. Les éléments en laiton de l'antenne sont protégés par un tube en fibre de verre conique robuste et de haute qualité. Développé avec des matériaux appropriés pour résister aux conditions environnementales marines difficiles. Montage facile à l'aide de supports BSP 1" (non inclus). Conçu pour une grande variété d'installations. Terminasion: N femelle. Chaque élément métallique d'antenne est mis à la terre en courant continu pour réduire le bruit causé par la décharge atmosphérique. Large bande passante par rapport au ROS et au gain. Il peut également s'agir d'une antenne de station de base.

FREQUENCY RANGE	156/162
GAIN	5.1dBi
NOMINAL IMPEDANCE	50 ohms
POLARIZATION	Vertical
VSWR	≤ 1,3 at 156,8 MHz
POWER RATING	100 W
DC GROUND	Yes
TERMINATION	N female
LENGHT	2.7 m / 8.9'
WEIGHT	650g / 23oz
INSTALLATION	1" BSP x tpi
TEMPERATURE RANGE	-40 / +60 °C
WIND RATING	60 m/s
COLOUR	white
MATERIAL	Fibreglass

More info on www.glomex.it

PUNTI CHIAVE: 5.1 dBi di guadagno. Antenna omnidirezionale collineare. Antenna con polarizzazione verticale, resistente alle sollecitazioni, leggera, resistente alla corrosione. Gli elementi in ottone dell'antenna sono protetti da una canna in fibra di vetro robusta e di alta qualità.

Realizzata con materiali appropriati per sostenere le dure condizioni ambientali marine. Facilità di montaggio usando supporti 1"GAS (non inclusi). Sviluppata per una ampia varietà di installazione. Terminazione: N femmina. Ogni elemento in metallo dell'antenna è DC-ground.

OPTIONAL ACCESSORIES



▲ PRM180 Electropolished AISI316 stainless steel deck mount



▲ PRM298 Electropolished AISI316 stainless steel pipe mounting bracket for vertical or horizontal mounting for tubes from 25 mm (1") to 80 mm (3")

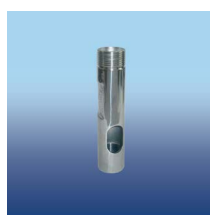

▲ PRM280 Electropolished AISI316 stainless adaptor 1" BSP x 11 tpi male to 1"x14 UNS female, with slot for cable



▲ RA118 100 m (328') RG-213/U MIL C17 white coax cable

PRA461B

2,7 m (8.9') 5.1 dBi VHF professional antenna

Category: VHF

Subcategory: SO239 termination

Code: PRA4461B

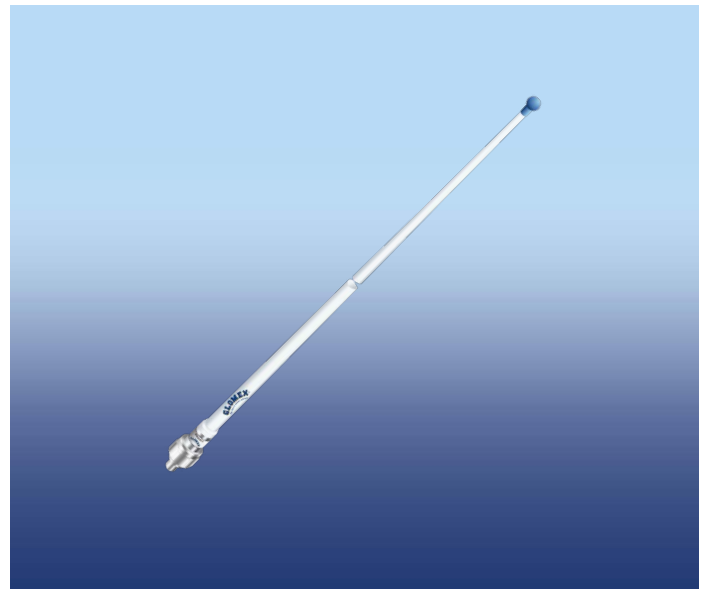

5.1 dBi gain antenna. Collinear coaxial omnidirectional dipole antenna. Vertically polarized, vibration proof, lightweight, corrosion resistant antenna. The antenna brass elements are protected by high quality and rugged tapered fibreglass tube. Developed with appropriate materials for withstanding harsh marine environmental conditions. Easy mounting using 1" BSP mounts (not included). Designed for a wide variety of installation.

Termination: SO239.

Each antenna metal element is DC-grounded for reducing the noise caused by atmospheric discharge. Wide bandwidth with respect to SWR and gain. It can be also a base station antenna.

FREQUENCY RANGE	156/162
GAIN	5.1dBi
NOMINAL IMPEDANCE	50 ohms
POLARIZATION	Vertical
VSWR	≤ 1,3 at 156,8 MHz
POWER RATING	100 W
DC GROUND	Yes
TERMINATION	SO239
LENGHT	2.7 m / 8.9'
WEIGHT	650g / 23oz
INSTALLATION	1" BSP x tpi
TEMPERATURE RANGE	-40 / +60 °C
WIND RATING	60 m/s
COLOUR	white
MATERIAL	Fibreglass

More info on www.glomex.it

Gain 5,1 dBi. Antenne dipôle omnidirectionnelle coaxiale collinéaire. Antenne polarisée verticalement, résistante aux vibrations, légère et résistante à la corrosion. Les éléments en laiton de l'antenne sont protégés par un tube en fibre de verre conique robuste et de haute qualité. Développé avec des matériaux appropriés pour résister aux conditions environnementales marines difficiles. Montage facile à l'aide de supports BSP 1" (non inclus). Conçu pour une grande variété d'installations. Terminasion: SO239. Chaque élément métallique d'antenne est mis à la terre en courant continu pour réduire le bruit causé par la décharge atmosphérique. Large bande passante par rapport au ROS et au gain. Il peut également s'agir d'une antenne de station de base.

PUNTI CHIAVE: 5.1 dBi di guadagno. Antenna omnidirezionale collineare. Antenna con polarizzazione verticale, resistente alle sollecitazioni, leggera, resistente alla corrosione. Gli elementi in ottone dell'antenna sono protetti da una canna in fibra di vetro robusta e di alta qualità.

Realizzata con materiali appropriati per sostenere le dure condizioni ambientali marine. Facilità di montaggio usando supporti 1" GAS (non inclusi). Sviluppata per una ampia varietà di installazione. Terminazione: SO239. Ogni elemento in metallo dell'antenna è DC-ground.

OPTIONAL ACCESSORIES



▲ PRM180 Electropolished AISI316 stainless steel deck mount



▲ PRM298 Electropolished AISI316 stainless steel pipe mounting bracket for vertical or horizontal mounting for tubes from 25 mm (1") to 80 mm (3")

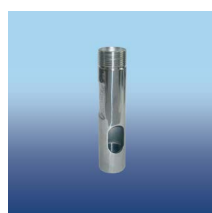

▲ PRM280 Electropolished AISI316 stainless adaptor 1" BSP x 11 tpi male to 1"x14 UNS female, with slot for cable



▲ RA118 100 m (328') RG-213/U MIL C17 white coax cable



PRA518

5.3 m (17.4') 6.6dBi VHF professional antenna

Category: VHF

Subcategory: FME termination

Code: PRA518



🇮🇹 6.6 dBi gain antenna. Phase 1/2 wave elements to Collinear array. Equipped with 6m RG-8X coaxial cable with pre-installed FME connector. . Vertically aligned with the exclusion of irradiation of the coax cable on the base. Extremely rugged fibreglass antenna structure. Vertically polarized, vibration proof, lightweight, corrosion resistant antenna. The antenna brass elements are protected by high quality and rugged fibreglass tube.

Developed with appropriate materials for withstanding harsh marine environmental conditions. Mounting with 1"x14 UNS mount + stand-off bracket (not included). Termination: 6m (20') RG-8X with pre-wired FME connector.

FREQUENCY RANGE	156/162
GAIN	6.6dBi
NOMINAL IMPEDANCE	50 ohms
POLARIZATION	Vertical
VSWR	≤ 1,3 at 156,8 MHz
POWER RATING	100 W
DC GROUND	Yes
TERMINATION	cable
LENGHT	5.3m/17,4' - in 2 sections (2.65+2.65m) / (8.7'+8,7')
WEIGHT	2,5kg/5.5lb
INSTALLATION	1"x14 UNS + stand-off
TEMPERATURE RANGE	-40 / +60 °C
WIND RATING	42 m/s
COLOUR	white
MATERIAL	Fibreglass
<i>More info on www.glomex.it</i>	

Gain 6,6 dBi. Éléments d'onde de phase 1/2 au réseau colinéaire. Équipé d'un câble coaxial RG-8X de 6 m avec connecteur FME pré-installé. Aligné verticalement à l'exclusion de l'irradiation du câble coaxial sur la base. Structure d'antenne en fibre de verre extrêmement robuste. Antenne polarisée verticalement, résistante aux vibrations, légère et résistante à la corrosion.

Les éléments en laiton de l'antenne sont protégés par un tube en fibre de verre robuste et de haute qualité. Développé avec des matériaux appropriés pour résister aux conditions environnementales marines difficiles. Montage avec support UNS 1"x14 + support d'écartement (non inclus). Terminaison : 6m (20') RG-8X avec connecteur FME pré-câblé

PUNTI CHIAVE: 6.6 dBi di guadagno. Antenna 1/2 onda. fornita con il cavo coassiale RG-8X lungo 6m precablato con connettore FME. Antenna in fibra di vetro dalla struttura estremamente robusta, Antenna in fibra di vetro con polarizzazione verticale, resistente alle vibrazioni, leggera, resistente alla corrosione antenna in fibra di vetro.

Gli elementi in ottone dell'antenna sono protetti da una canna in fibra di vetro robusta e di alta qualità. Sviluppata con materiali appropriati per resistere alle dure condizioni ambientali marine. Installazione con supporti 1"x14 UNS + staffe stand-off (non incluse). Terminazione:cavo

SUPPLIED ACCESSORIES



▲ 6m (20') RG-8X coax cable with pre-wired FME connector

OPTIONAL ACCESSORIES

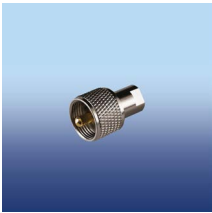

▲ RA351 FME/PL-259 adaptor connector



▲ 4 way ratched mout in stainless steel - handle locking - hole for cable - standard thread 1"x14.



PRA110

1 m (3') rugged VHF professional antenna

Category: VHF

Subcategory: N female termination

Code: PRA110



3.1 dBi gain antenna Vertically polarized, vibration proof, lightweight, corrosion resistant antenna. The antenna brass elements are protected by high quality and rugged fibreglass tube. Developed with appropriate materials for withstanding harsh marine environmental conditions. Each antenna metal element is DC-grounded for reducing the noise caused by atmospheric discharge.

Wide vertical irradiation plan for effective communication also when, because of boat rolling and pitching, the antenna is not perfectly vertical. Integrated 1"x14 UNS stainless steel adaptor for an easy mounting. N female termination.

Gain 3,1 dBi. Antenne à polarisation verticale, résistante aux vibrations, légère et résistante à la corrosion. Les éléments en laiton de l'antenne sont protégés par un tube en fibre de verre robuste et de haute qualité. Développé avec des matériaux appropriés pour résister aux conditions environnementales marines difficiles.

Chaque élément métallique d'antenne est mis à la terre en courant continu pour réduire le bruit causé par la décharge atmosphérique. Plan d'irradiation vertical large pour une communication efficace même lorsque, en raison du roulis et du tangage du bateau, l'antenne n'est pas parfaitement verticale. Adaptateur intégré en acier inoxydable 1"x14 UNS pour un montage facile. Terminaison N femelle.

FREQUENCY RANGE	156/162
GAIN	3.1dBi
NOMINAL IMPEDANCE	50 ohms
POLARIZATION	Vertical
VSWR	≤ 1,3 at 156,8 MHz
POWER RATING	100 W
DC GROUND	Yes
TERMINATION	N female
LENGHT	1m/3'
WEIGHT	770g/27,16o
INSTALLATION	7/8" -22mm
TEMPERATURE RANGE	-40 / +60 °C
WIND RATING	60 m/s
COLOUR	white
MATERIAL	Fibreglass

More info on www.glomex.it

PUNTI CHIAVE: 3.1 dBi di guadagno. Antenna con polarizzazione verticale, resistente alle sollecitazioni, leggera, resistente alla corrosione. Gli elementi in ottone dell'antenna sono protetti da una canna in fibra di vetro robusta e di alta qualità. Realizzata con materiali appropriati per sostenere le dure condizioni ambientali marine.

Ogni elemento in metallo dell'antenna è DC-ground. Ampio lobo di irradiazione verticale per una comunicazione efficace anche quando, a causa del beccheggio della barca, l'antenna non è perfettamente verticale. Adattatore 1"x14 UNS in acciaio inox integrato per un facile montaggio. Terminazione: N femmina.

OPTIONAL ACCESSORIES



▲ RA118 100 m (328') RG-213/U MIL C17 white coax cable

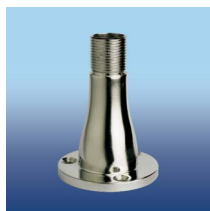

▲ V9174 Universal mount stainless steel for antennas and extensions. Standard thread 1"x14



▲ RA116SS 4 way ratched mout in stainless steel, handle locking, hole for cable, standard thread 1"x14

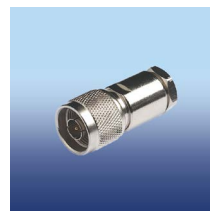

▲ RA158 N male connector for RG-213/U coax cable

PRA601

7 m (23') very rugged HF/SSB professional antenna with side termination feed

Category: HF/SSB

Subcategory: 7m (23') 2 sections

Code: PRA601



 Guarantee great performance. Lightweight antenna. Vibration proof, corrosion resistant antenna. Internal elements protected by high quality and rugged fibreglass tube.

Developed with appropriate materials for withstanding harsh marine environmental conditions. Mounting with 1"x14 UNS mount + stand-off bracket (not included). Side termination feed

 Garanties d'excellentes performances. Antenne légère. Antenne résistante aux vibrations et à la corrosion. Éléments internes protégés par un tube en fibre de verre robuste et de haute qualité.

Développé avec des matériaux appropriés pour résister aux conditions marines difficiles. Conditions environnementales Montage avec support UNS 1"x14 + support d'écartement (non inclus). Alimentation de terminaison latérale.

 Garanzia di alte prestazioni. Antenna dal peso leggero. Antenna resistente alle vibrazioni e alla corrosione. Gli elementi interni sono protetti da una canna robusta e di alta qualità.

Sviluppata con materiali appropriati per resistere alle dure condizioni ambientali marine. Installazione con supporti 1"x14 UNS + staffe stand-off (non incluse). Terminazione laterale.



FREQUENCY RANGE	2 - 30 MHz with tuners
POLARIZATION	Vertical
VSWR	≤ 1,3 at 156,8 MHz
POWER RATING	400 W
TX/RX MODE	TC/RX
TERMINATION	Side feed termination bolt
LENGTH	7m/23' - in 2 sections (4+3m) / (13'+9,84')
WEIGHT	2,16kg/4,76lb
INSTALLATION	1"x14 UNS + stand-off
TEMPERATURE RANGE	-40 / +60 °C
WIND RATING	42 m/s
COLOUR	white
MATERIAL	Fibreglass
<i>More info on www.glomex.it</i>	

OPTIONAL ACCESSORIES



▲ RA116SS 4 way ratched mount in stainless steel, handle locking, hole for cable, standard thread 1"x14



▲ RA119 Stand-off bracket in reinforced nylon



▲ RA176 4 way stainless steel free swivel mount

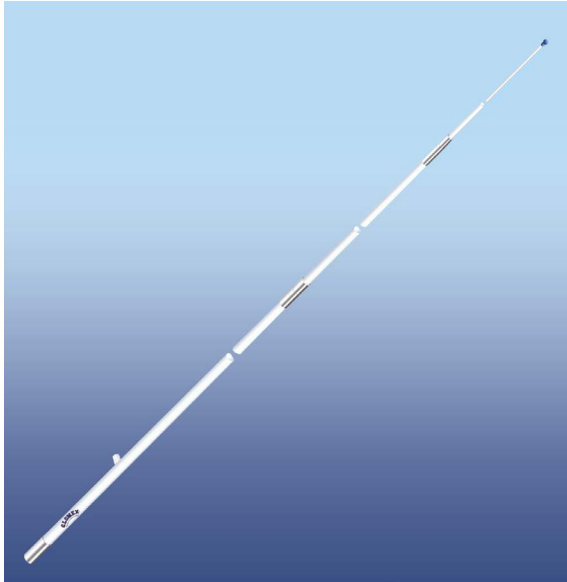

PRA703

7 m (23') HF/SSB professional antenna with side termination feed

Category: HF/SSB

Subcategory: 7m (23') 3 sections

Code: PRA703



UK Guarantee great performance. Completely insulated. Suitable for a great variety of installation. Vibration proof, lightweight, corrosion resistant antenna. Internal elements protected by high quality and rugged fibreglass tube.

Developed with appropriate materials for withstanding harsh marine environmental conditions. Mounting with 1"x14 UNS mount + stand-off bracket (not included). Side termination feed. Easy shipping packaging: strong tube O.D. 80mm (3") – length 2,55 m(8,36')

FR Garanties d'excellentes performances. Entièrement isolé. Convient à une grande variété d'installations. Antenne résistante aux vibrations, légère et résistante à la corrosion. Éléments internes protégés par un tube en fibre de verre robuste et de haute qualité.

Développé avec des matériaux appropriés pour résister aux conditions marines difficiles. Conditions environnementales. Montage avec support UNS 1"x14 + support d'écartement (non inclus) Alimentation de terminaison latérale. Emballage d'expédition facile: tube solide O.D. 80mm – longueur 2,55m.

IT Totalmente isolata, Adatta a molteplici modalità di installazione, Antenna resistente alle vibrazioni, leggera e resistente alla corrosione, Gli elementi interni sono protetti da una canna robusta e di alta qualità,

Sviluppata con materiali appropriati per resistere alle dure condizioni ambientali marine. Installazione con supporti 1"x14 UNS + staffe stand-off (non incluse), Terminazione laterale, Easy shipping packaging grazie al tubo resistente O.D. 80mm (3") – lungo 2,55 m.

FREQUENCY RANGE	2 - 30 MHz with tuners
POLARIZATION	Vertical
POWER RATING	800 W
TX/RX MODE	TC/RX
TERMINATION	Side feed termination bolt
LENGHT	7m/23' - in 3 sections (2,35+2,35+2,4m) / (7,7'+7,7'+7,55')
WEIGHT	2,465kg/5,4lb
INSTALLATION	1"x14 UNS + stand-off
TEMPERATURE RANGE	-40 / +60 °C
WIND RATING	42 m/s
COLOUR	white
MATERIAL	Fibreglass
<i>More info on www.glomex.it</i>	

OPTIONAL ACCESSORIES



▲ RA176 4 way stainless steel free swivel mount

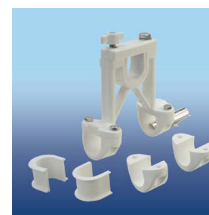

▲ RA119 Stand-off bracket in reinforced nylon



▲ RA116SS 4 way ratched mout in stainless steel, handle locking, hole for cable, standard thread 1"x14

PRA702

4,73 m (15.5') HF/SSB professional antenna with side termination feed

Category: HF/SSB

Subcategory: 4,75m (15.5') 2 sections

Code: PRA702



Guarantee great performance. Suitable for a great variety of installation. Vibration proof, lightweight, corrosion resistant antenna. Internal elements protected by high quality and rugged fibreglass tube.

Developed with appropriate materials for withstanding harsh marine environmental conditions. Mounting with 1"x14 UNS mount + stand-off bracket (not included). Side termination feed. Easy shipping packaging. Developed for automatic antenna tuner

Garanties d'excellentes performances. Entièrement isolé. Convient à une grande variété d'installations. Antenne résistante aux vibrations, légère et résistante à la corrosion. Éléments internes protégés par un tube en fibre de verre robuste et de haute qualité.

Développé avec des matériaux appropriés pour résister aux conditions marines difficiles. Conditions environnementales. Montage avec support UNS 1"x14 + support d'écartement (non inclus). Alimentation de terminaison latérale. Emballage d'expédition facile: tube solide O.D. 80mm – longueur 2,55 m.

Grandi Performance. Grande varietà di installazione. Antenna resistente alle vibrazioni, leggera e resistente alla corrosione. Gli elementi interni sono protetti da una canna robusta e di alta qualità.

Sviluppata con materiali appropriati per resistere alle dure condizioni ambientali marine. Installazione con base 1"x14 UNS + staffa (non inclusi), Terminazione laterale. Sviluppata per utilizzo con tuner automatici.

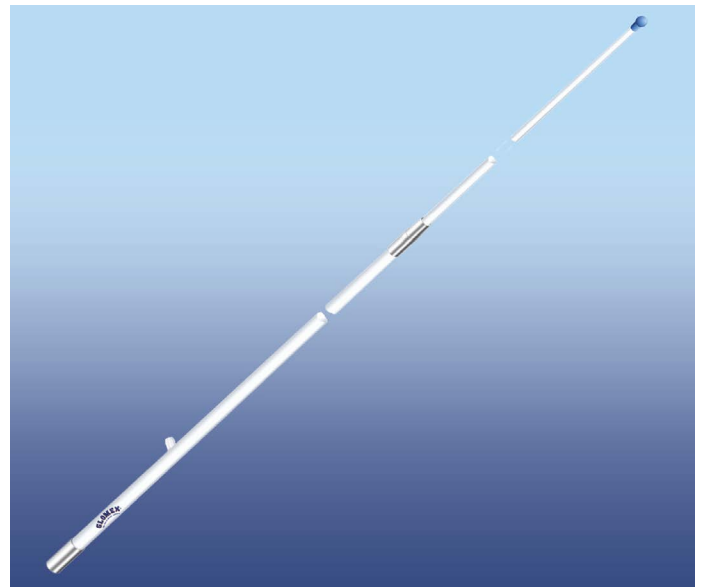

FREQUENCY RANGE	2 - 30 MHz with tuners
POLARIZATION	Vertical
POWER RATING	500 W
TX/RX MODE	TC/RX
TERMINATION	Side feed termination bolt
LENGTH	4,73m / 15,5' - in 2 sections (2,4+2,33m) / (7,8'+7,7')
WEIGHT	1,5kg / 3,3lb
INSTALLATION	1"x14 UNS + stand-off
TEMPERATURE RANGE	-40 / +60 °C
WIND RATING	42 m/s
COLOUR	white
MATERIAL	Fibreglass

More info on www.glomex.it

OPTIONAL ACCESSORIES



▲ RA176 4 way stainless steel free swivel mount



▲ RA119 Stand-off bracket in reinforced nylon



▲ RA116SS 4 way ratched mout in stainless steel, handle locking, hole for cable, standard thread 1"x14



PRA471

1,2m (4') high gain dualband omnidirectional marine antenna for Wi-fi and other 2.4GHz and 5GHz applications.

Category: Wi-Fi

Code: PRA471



UK 12 dBi gain antenna. Dualband Wi-Fi omnidirectional marine antenna (2.4 GHz and 5 GHz). Vertically polarized, vibration proof, lightweight, corrosion resistant antenna. The antenna brass elements are protected by high quality and rugged fibreglass tube.

Developed with appropriate materials for withstanding harsh marine environmental conditions. Easy mounting using 1" BSP mounts (not included). N female termination

FR Gain 12 dBi. Antenne marine omnidirectionnelle Wi-Fi bibande (2,4 GHz et 5 GHz). Antenne polarisée verticalement, résistante aux vibrations, légère et résistante à la corrosion. Les éléments en laiton de l'antenne sont protégés par une haute qualité et tube en fibre de verre robuste.

Développé avec des matériaux appropriés pour résister aux conditions marines difficiles. Conditions environnementales. Montage facile à l'aide de supports BSP 1" (non inclus). Terminaison N femelle.

FREQUENCY RANGE	2.4 - 2.5 GHz / 5.55 - 5.85 GHz
GAIN	12dBi
POLARIZATION	Vertical
NOMINAL IMPEDANCE	50 ohms
POWER RATING	100 W
VSWR	≤ 1,3
TX/RX MODE	TC/RX
TERMINATION	N female
LENGHT	1,2m/4'
WEIGHT	542g/17,43oz
INSTALLATION	1" BSP x 11 tpi
TEMPERATURE RANGE	-40 / +60 °C
WIND RATING	60 m/s
COLOUR	white
MATERIAL	Fibreglass
<i>More info on www.glomex.it</i>	

IT PUNTI CHIAVE: 12 dBi di guadagno. Antenna marina omnidirezionale dualband Wi-Fi (2.4 GHz and 5 GHz). Antenna in polarizzazione verticale, leggera e resistente alle vibrazioni e alla corrosione. Gli elementi interni in ottone sono protetti da una canna in fibra di vetro estremamente robusta.

Sviluppata con materiali adeguati per resistere alle più estreme condizioni ambientali. Montaggio facile con supporti 1" BSP (non inclusi). Terminazione: N femmina.

OPTIONAL ACCESSORIES



▲ PRM180 Electropolished AISI316 stainless steel deck mount



▲ PRM298 Electropolished AISI316 stainless steel pipe mounting bracket for vertical or horizontal mounting for tubes from 25 mm (1") to 80 mm (3")



▲ PRM162 Electropolished stainless steel masthead bracket with 1"x14 nut and washer

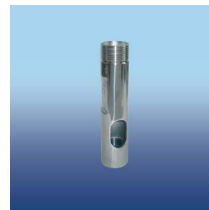

▲ PRM280 Electropolished AISI316 stainless adaptor 1" BSP x 11 tpi male to 1"x14 UNS female, with slot for cable

PRA485A

44cm (17.3") high gain multi-band 5G/4G-LTE/GSM/UMTS/GRPS marine antennas

Category: COASTAL INTERNET

Code: PRA485A



3 dB gain antenna. Multi-band 5 G / 4 G - LTE / GSM / UMTS / GRPS marine antenna. Vertically polarized, vibration proof, lightweight, corrosion resistant antenna. The antenna brass elements are protected by high quality and rugged fibreglass tube.

Developed with appropriate materials for withstanding harsh marine environmental conditions. Easy mounting using 1" BSP mounts (not included). N female termination.

Gain 3 dB. Antenne marine multibande LTE / GSM / UMTS / GPRS. Antenne polarisée verticalement, résistante aux vibrations, légère et résistante à la corrosion. Les éléments en laiton de l'antenne sont protégés par un tube en fibre de verre robuste et de haute qualité.

Développé avec des matériaux appropriés pour résister aux conditions environnementales marines difficiles. Montage facile à l'aide de supports BSP 1" (non inclus). Terminaison N femelle.

3 dB di guadagno. Antenna marine multi-banda LTE / GSM / UMTS / GPRS. Antenna in polarizzazione verticale, leggera e resistente alle vibrazioni e alla corrosione. Gli elementi interni in ottone sono protetti da una canna in fibra di vetro estremamente robusta.

Sviluppata con materiali adeguati per resistere alle più estreme condizioni ambientali. Montaggio facile con supporti 1" BSP (non inclusi). Terminazione: N femmina.



FREQUENCY RANGE	806-900MHz/840-940MHz/1800-1710MHz 1900-1990MHz/1920-2170MHz/2600MHz
GAIN	3dBi
NOMINAL IMPEDANCE	50 ohms
POLARIZATION	Vertical
TERMINATION	N female
LENGHT	44cm/17.3'
WEIGHT	250g/8.8oz
INSTALLATION	1" BSP x 11 tpi
TEMPERATURE RANGE	-40 / +60 °C
WIND RATING	60 m/s
COLOUR	white
MATERIAL	Fibreglass

More info on www.glomex.it

OPTIONAL ACCESSORIES



▲ PRM180 Electropolished AISI316 stainless steel deck mount



▲ PRM298 Electropolished AISI316 stainless steel pipe mounting bracket for vertical or horizontal mounting for tubes from 25 mm (1") to 80 mm (3")



▲ PRM280 Electropolished AISI316 stainless adaptor 1" BSP x 11 tpi male to 1" x 14 UNS female, with slot for cable



▲ PRM162 Electropolished stainless steel masthead bracket with 1" x 14 nut and washer



PRM298



Electropolished AISI316 stainless steel pipe mounting bracket for vertical or horizontal mounting for tubes from 25 mm (1") to 80 mm (3").

Category: Accessories

Subcategory: Brackets

Code: PRM298



-  Electropolished AISI316 stainless steel pipe mounting bracket for vertical or horizontal mounting for tubes from 25 mm (1") to 80 mm (3").
-  Support de montage sur tube en acier inoxydable AISI 316 électropoli pour montage vertical ou horizontal pour tubes de 25mm à 80mm.
-  Staffa in acciaio inox elettrolucidato AISI 316 per montaggio orizzontale o verticale per tubi da 25 mm a 80 mm.

PRM280

Electropolished AISI316 stainless adaptor 1" BSP x 11 tpi male to 1"x14 UNS female - with slot for cable.

Category: Accessories

Subcategory: 1" BSP/1"x14 adaptor

Code: PRM280

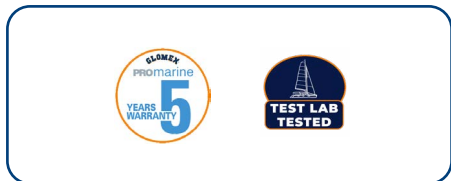

- 🇬🇧 Electropolished AISI316 stainless adaptor 1" BSP x 11 tpi male to 1"x14 UNS female - with slot for cable.
- 🇫🇷 Adaptateur en acier inoxydable AISI316 électropoli 1" BSP x 11 tpi mâle vers 1"x14 UNS femelle - avec fente pour câble.
- 🇮🇹 Adattatore in acciaio inox elettrolucidato AISI 316 1" BSP x tpi maschio a 1"x14 UNS femmina. Dotato di slot per cavo.

PRM180

Electropolished AISI316 stainless steel deck mount for 1" BSP thread antennas

Category: Accessories

Subcategory: Deck mounts

Code: PRM180

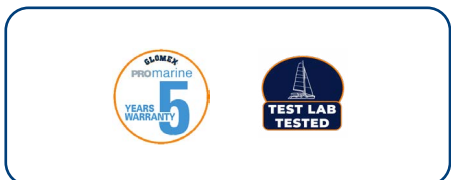

- 🇬🇧 Electropolished AISI316 stainless steel deck mount for 1" BSP thread antennas.
- 🇫🇷 Support de pont en acier inoxydable AISI316 électropoli. Filetage 1" BSP mâle x tpi.
- 🇮🇹 Base in acciaio inox elettrolucidato AISI 316 per PRA444, PRA451A, PRA451B, PRA471 e PRA473EXT. Filettatura 1" GAS.



RA119

Stand-off bracket in reinforced nylon for ssb antennas and extensions.

Category: Accessories

Subcategory: Brackets

Code: RA119



Stand-off bracket reinforced nylon. For bulkhead and rail of Ø 1" (25 mm) and 1¼" (30 mm). Suitable for Ø 1½" (38,5 mm) antennas and is supplied with plastic inserts for extensions diam. 1" (25 mm), 1 1/8" (28 mm) and 1¼" (30 mm).

Support intermédiaire en nylon renforcé. Fixation sur cloison ou balcon (diam. 25 mm ou 30mm). Pour antennes de diamètre de 38,5 mm (1½") et avec adaptateurs de diamètre de 25mm, 28mm et 30mm.

Staffa intermedia di fissaggio in nylon rinforzato per fissaggio su diametri di 25 mm (1"), 30 mm (1¼"). Adattabile anche ad antenne con diametro da 38,5 mm (1½") e fornita con accessori di diverso diametro per estensioni con diametro di 25 mm (1"), 28 mm (1 1/8") e 30 mm (1¼").

OPTIONAL ACCESSORIES



▲ RA176 4 way stainless steel free swivel mount



▲ RA116SS 4 way ratched mout in stainless steel, handle locking, hole for cable, standard thread 1"x14



▲ RA166/00 4 way ratched mout in stainless steel, handle locking, hole for cable, standard thread 1"x14

RA116SS

4 way ratched mout in stainless steel, handle locking, hole for cable, standard thread 1"x14

Category: Accessories

Subcategory: Ratchet mounts

Code: RA116SS



 Heavy duty 4 way ratchet mount polished stainless steel design with handle, for deck or bulkhead. Hole for GPS and feed-thru for coax cable. Standard 1"x14 thread.

 Support double articulation en acier inoxydable poli, pour fixation sur pont ou cloison, avec blocage par levier. Passécâble pour câble coaxial et GPS. Filetage standard 1"x14.

 Base a doppio snodo in acciaio inox elettrolucidato, con bloccaggio a leva, per pulpito o ponte. Foro per cavo GPS e passacavo per cavo coassiale. Filettatura standard 1"x14.



V9171



Stainless steel bracket - horizontal and vertical rail - standard thread 1"x14.

Category: Accessories

Subcategory: Brackets

Code: V9171



-  Pipe mounting bracket in stainless steel. Mounts on vertical or horizontal rails diam. 7/8" (22 mm) to 3" (80 mm). Standard thread 1"x14, weight 21 oz (600 gr).
-  Rotule en acier inox inoxydable pour fixation horizontale ou verticale sur balcon de diamètre de 22 à 80 mm. Filetage standard 1"x14, poids 600 grs.
-  Staffa in acciaio inox elettrolucidato, per installazione su tubo orizzontale o verticale di diametro da 22 (7/8") a 80 mm (3"). Filettatura standard 1"x14, peso 600 gr.

RA176

4 way stainless steel free swivel mount

Category: Accessories

Subcategory: free swivel mounts

Code: RA176

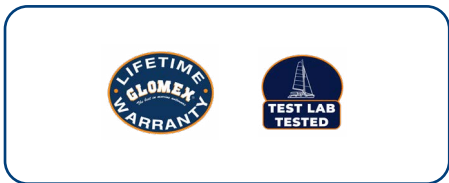

🇬🇧 4 way stainless steel free swivel mount for any mounting location. Designed for a quick antenna lowering, it must be coupled with a stand-off bracket. Standard 1"x14 thread. RA176 must be coupled with RA819 stand-off bracket (not included) for installing the following antennas: PRA800, PRA900 and PRA903. Moreover, RA176 must be coupled with RA119 stand-off bracket (not included) for installing the following antennas: PRA702, PRA703 and PRA601.

🇫🇷 Support double articulation sans blocage en acier inoxydable, pour tous les emplacements de montage. Conçu pour une rapide descente de l'antenne, il doit être couplé avec un support intermédiaire. Filetage standard 1"x14. RA176 doit être utilisé avec le support intermédiaire RA119 (ne pas inclu) pour l'installation des antennes: PRA702, PRA703 et PRA601.

🇮🇹 Base libera a doppio snodo in acciaio inox, installabile in qualsiasi posizione. Progettata per un rapido e facile abbattimento dell'antenna. Deve necessariamente essere abbinata ad uno stand-off bracket. Filettatura standard 1"x14. RA176 deve essere utilizzata insieme alla staffa RA819 (non inclusa) per l'installazione delle antenne PRA800, PRA900 e PRA903. Mentre la RA176 deve essere utilizzata insieme alla staffa RA119 (non inclusa) per l'installazione delle antenne PRA702, PRA703 e PRA601.

V9174

Universal electropolished stainless steel mount for antennas and extensions - 100 mm (4") - standard thread 1"x14.

Categories: Accessories

Subcategory: deck mounts

Code: V9174

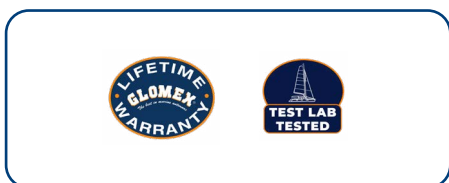

🇬🇧 Universal mount stainless steel for antennas and extensions. Standard thread 1"x14, weight 10 oz (280 g), height 4" (100 mm).

🇫🇷 Support universel renforcé en acier inoxydable poli pour antennes et rallonges. Filetage standard 1"x14, poids 280g, hauteur 100mm.

🇮🇹 Supporto universale in acciaio inox elettrolucidato, per antenne e prolunghe. Filettatura standard 1"x14, peso 280 g (5,3 oz), altezza 100 mm (13/8").

PRM240

Electropolished AISI 316 stainless steel 1" BSP x 11 tpi male top ferrule with o-ring for PRA451, PRA452, PRA462, PRA471 and PRA485 antennas.

Category: Accessories

Subcategory: 1" BSP top ferrule

Code: PRM240



🇬🇧 Electropolished AISI 316 stainless steel 1" BSP x 11 tpi male top ferrule with o-ring for PRA451, PRA452, PRA462, PRA471 and PRA485 antennas.

🇫🇷 Acier inoxydable AISI 316 électropoli 1" BSP x 11 tpi ferrule supérieure mâle avec joint torique pour antennes PRA451, PRA452, PRA462, PRA471 and PRA485

🇮🇹 Ghiera 1" BSP x 11 tpi in acciaio inox AISI 316 con o-ring per antenne PRA451, PRA452, PRA462, PRA471 and PRA485

RA133

PL-258 double female connector for PL-259. Nickel plated (vhf/cb)

Category: Accessories

Subcategory: connectors

Code: RA133



🇬🇧 PL-258 double female connector for PL-259. Nickel plated (vhf/cb)

🇮🇹 Connettore PL258 doppia femmina per PL259. Nichelato (vhf/cb)

🇫🇷 PL258 double femelle connecteur pour PL259. Plaqué nickel (vhf/cb).

RA131

PL-259 male connector for RG213/U cable (vhf)

Category: Accessories

Subcategory: connectors

Code: RA131



🇬🇧 PL-259 male connector for RG213/U cable (vhf).

🇫🇷 Connecteur PL259 mâle pour câble RG213/U (vhf).

🇮🇹 Connettore PL259 maschio per cavo RG213/U (vhf).

RA116RFC

Stainless steel inside reinforcement plate for fibreglass boats for RA116SS and RA819

Category: Accessories

Subcategory: reinforced plate

Code: RA116RFC



🇬🇧 Stainless steel inside reinforcement plate for fibreglass boats for RA116SS and RA819

🇫🇷 Plaque de renforcement en acier inoxydable électro-poli pour bateaux en fibre de verre pour RA116SS et RA819.

🇮🇹 Piastra di rinforzo in acciaio inox elettrolucidato per barche in vetroresina per RA116SS e RA819.

OPTIONAL ACCESSORIES



▲ RA116/SS 4 way ratched mout in stainless steel, handle locking, hole for cable, standard thread 1"x14

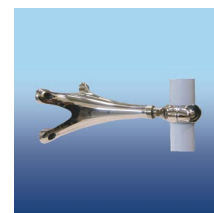

▲ RA819 Stainless steel stand off bracket for HF/SSB professional antennas





RA158

N male connector for RG-213/U cable (cell/vhf)

Category: Accessories

Subcategory: connectors

Code: RA158

-  N male connector for RG-213/U cable (cell/vhf)
-  Connecteur N mâle pour câble RG213/U (cell/vhf).
-  Connettore N maschio per cavo RG213/U (cell/vhf)

SUPPLIED ACCESSORIES



▲ RA118, 100 m (328')
RG-213/U MIL C17 white
coax cable

RA118

100 m (328') RG-213/U mil C17 white coax cable

Category: Accessories

Subcategory: Coax cables

Code: RA118



🇺🇸 Coaxial cables transmit signals to and from the antenna. Poor quality cables will dramatically reduce the efficiency of both antenna and transceivers. All coaxial cables can lose efficiency over time due to humidity. Glomex cables are specifically designed and manufactured for use in the marine environment. All Glomex cables have been developed in cooperation with coaxial cables specialists to ensure minimal signal distortion or loss and long term reliability.

🇫🇷 Les câbles coaxiaux transmettent les signaux vers l'antenne et vice-versa. Les câbles coaxiaux peuvent perdre de leur efficacité avec le temps dans un milieu humide, mais les câbles Glomex sont conçus et fabriqués spécialement pour être utilisés dans un milieu marin et pour résister aussi longtemps aux effets négatifs du brouillard salin. Tous les câbles Glomex ont été développés en coopération avec des spécialistes du câble coaxial pour minimiser la distorsion et la perte de la qualité du signal et assurer une fiabilité à long terme.

🇮🇹 I cavi coassiali trasmettono segnali da e verso l'antenna. Cavi di scarsa qualità ridurranno drasticamente l'efficienza sia dell'antenna che dei ricetrasmittitori. Tutti i cavi coassiali possono perdere efficienza nel tempo a causa dell'umidità. I cavi Glomex sono specificamente progettati e realizzati per l'utilizzo in ambiente marino. Tutti i cavi Glomex sono stati sviluppati in collaborazione con specialisti di cavi coassiali per garantire una minima distorsione o perdita del segnale e affidabilità a lungo termine.

OPTIONAL ACCESSORIES



▲ RA158 N male connector for RG-213/U cable (cell/vhf)



RA206

55 mm (2¼") diameter round ground plate

Category: Accessories

Subcategory: Ground plates

Code: RA206

Le piastre di messa a terra o di massa sono un'interfaccia necessaria tra i dispositivi elettronici di bordo e il dissipatore di calore: l'acqua. Le piastre di messa a terra Glomex sono realizzate in bronzo sinterizzato dorato, ovvero sono costituite da un milione di microsferiche che creano una superficie 10 volte più grande di quella attuale. Possono avere forma rettangolare o circolare, e sono fissati allo scafo mediante bulloni e dadi in bronzo, altamente resistenti alla corrosione, e distanziali in gomma. La forma esclusiva offerta da Glomex assicura una superficie più ampia e una maggiore resistenza.

Les plaques de masse sont une interface nécessaire entre les dispositifs électroniques de bord et l'élément de dissipation thermique: l'eau. Les plaques de masse Glomex sont faites en bronze doré fritté, c'est-à-dire, qu'elles se composent de millions de microsphères pouvant atteindre une superficie jusqu'à 10 fois supérieure à celle de la plaque. Elles peuvent être de forme rectangulaire ou ronde et sont fixées au-dessous de la coque à l'aide de vis et d'écrous en bronze, hautement résistants à la corrosion, et d'entretoises isolantes en caoutchouc. Sa forme exclusive conçue par Glomex garantit une plus grande superficie et une meilleure résistance.

Le piastre di messa a terra o di massa sono un'interfaccia necessaria tra i dispositivi elettronici di bordo e il dissipatore di calore: l'acqua. Le piastre di messa a terra Glomex sono realizzate in bronzo sinterizzato dorato, ovvero sono costituite da un milione di microsferiche che creano una superficie 10 volte più grande di quella attuale. Possono avere forma rettangolare o circolare, e sono fissati allo scafo mediante bulloni e dadi in bronzo, altamente resistenti alla corrosione, e distanziali in gomma. La forma esclusiva offerta da Glomex assicura una superficie più ampia e una maggiore resistenza.

SUPPLIED ACCESSORIES

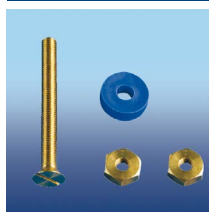

▲ Bronze screw, bolts and nuts

RA202

128 mm (5") diameter round ground plate - equivalent surface 1,7 m² (18,3 ft²).

Category: Accessories

Subcategory: Ground plates

Code: RA202



⚓ Earthing or ground plates are a necessary interface between on board electronic devices and the heat sink: water.. Glomex earthing plates are made of golden sintered bronze, that is, they consist of a million microspheres creating a surface 10 times bigger than the actual one. They can have either a rectangular or a circular shape, and are fastened to the hull by means of bronze bolts and nuts, highly resistant to corrosion, and rubber spacers. The exclusive shape offered by Glomex assures a larger surface and a better strength.

🇫🇷 Les plaques de masse sont une interface nécessaire entre les dispositifs électroniques de bord et l'élément de dissipation thermique: l'eau. Les plaques de masse Glomex sont faites en bronze doré fritté, c'est-à-dire, qu'elles se composent de millions de microsphères pouvant atteindre une superficie jusqu'à 10 fois supérieure à celle de la plaque. Elles peuvent être de forme rectangulaire ou ronde et sont fixées au-dessous de la coque à l'aide de vis et d'écrous en bronze, hautement résistants à la corrosion, et d'entretoises isolantes en caoutchouc. Sa forme exclusive conçue par Glomex garantit une plus grande superficie et une meilleure résistance.

🇮🇹 Le piastre di messa a terra o di terra sono un'interfaccia necessaria tra i dispositivi elettronici di bordo e il dissipatore di calore: l'acqua. Le piastre di terra Glomex sono realizzate in bronzo sinterizzato dorato, ovvero sono costituite da un milione di microsferiche che creano una superficie 10 volte più grande di quella attuale. Possono avere forma rettangolare o circolare, e sono fissati allo scafo mediante bulloni e dadi in bronzo, altamente resistenti alla corrosione, e distanziali in gomma. La forma esclusiva offerta da Glomex assicura una superficie maggiore e una maggiore robustezza.

SUPPLIED ACCESSORIES

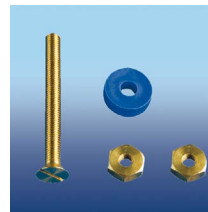

▲ Bronze screw, bolts and nuts



RA203

155x51x13 mm (6x2x1/2") rectangular ground plate - equivalent surface 1,15 m² (12,4 ft²).

Category: Accessories

Subcategory: Ground plates

Code: RA203

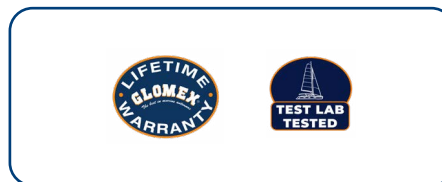

⚓ Earthing or ground plates are a necessary interface between on board electronic devices and the heat sink: water. Glomex earthing plates are made of golden sintered bronze, that is, they consist of a million microspheres creating a surface 10 times bigger than the actual one. They can have either a rectangular or a circular shape, and are fastened to the hull by means of bronze bolts and nuts, highly resistant to corrosion, and rubber spacers. The exclusive shape offered by Glomex assures a larger surface and a better strength.

🇫🇷 Les plaques de masse sont une interface nécessaire entre les dispositifs électroniques de bord et l'élément de dissipation thermique: l'eau. Les plaques de masse Glomex sont faites en bronze doré fritté, c'est-à-dire, qu'elles se composent de millions de microsphères pouvant atteindre une superficie jusqu'à 10 fois supérieure à celle de la plaque. Elles peuvent être de forme rectangulaire ou ronde et sont fixées au-dessous de la coque à l'aide de vis et d'écrous en bronze, hautement résistants à la corrosion, et d'entretoises isolantes en caoutchouc. Sa forme exclusive conçue par Glomex garantit une plus grande superficie et une meilleure résistance.

🇮🇹 Le piastre di messa a terra o di massa sono un'interfaccia necessaria tra i dispositivi elettronici di bordo e il dissipatore di calore: l'acqua. Le piastre di messa a terra Glomex sono realizzate in bronzo sinterizzato dorato, ovvero sono costituite da un milione di microsferiche che creano una superficie 10 volte più grande di quella attuale. Possono avere forma rettangolare o circolare, e sono fissate allo scafo mediante bulloneria in bronzo, altamente resistente alla corrosione, e distanziali in gomma. La forma esclusiva offerta da Glomex assicura una superficie maggiore e una maggiore robustezza.

SUPPLIED ACCESSORIES

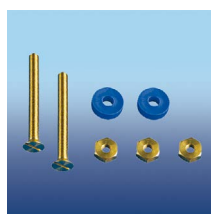

▲ Bronze screws, bolts and nuts

RA204

205x64x13 mm (8x2½x½") rectangular ground plate - equivalent surface 2 m² (21,5 ft²).

Category: Accessories

Subcategory: Ground plates

Code: RA204

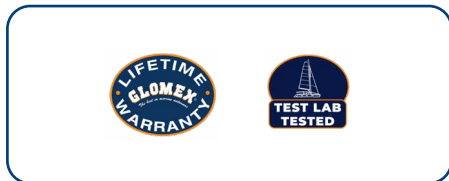

🇺🇸 Earthing or ground plates are a necessary interface between on board electronic devices and the heat sink: water. Glomex earthing plates are made of golden sintered bronze, that is, they consist of a million microspheres creating a surface 10 times bigger than the actual one. They can have either a rectangular or a circular shape, and are fastened to the hull by means of bronze bolts and nuts, highly resistant to corrosion, and rubber spacers. The exclusive shape offered by Glomex assures a larger surface and a better strength.

🇫🇷 Les plaques de masse sont une interface nécessaire entre les dispositifs électroniques de bord et l'élément de dissipation thermique: l'eau. Les plaques de masse Glomex sont faites en bronze doré fritté, c'est-à-dire, qu'elles se composent de millions de microsphères pouvant atteindre une superficie jusqu'à 10 fois supérieure à celle de la plaque. Elles peuvent être de forme rectangulaire ou ronde et sont fixées au-dessous de la coque à l'aide de vis et d'écrous en bronze, hautement résistants à la corrosion, et d'entretoises isolantes en caoutchouc. Sa forme exclusive conçue par Glomex garantit une plus grande superficie et une meilleure résistance.

🇮🇹 Le piastra di messa a terra o di massa sono un'interfaccia necessaria tra i dispositivi elettronici di bordo e il dissipatore di calore: l'acqua. Le piastre di messa a terra Glomex sono realizzate in bronzo sinterizzato dorato, ovvero sono costituite da un milione di microsferiche che creano una superficie 10 volte più grande di quella attuale. Possono avere forma rettangolare o circolare, e sono fissate allo scafo mediante bulloneria in bronzo, altamente resistente alla corrosione, e distanziali in gomma. La forma esclusiva offerta da Glomex assicura una superficie maggiore e una maggiore robustezza.

SUPPLIED ACCESSORIES

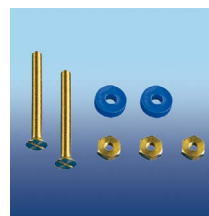

▲ Bronze screws, bolts and nuts



RA205

300x80x13 mm (12x3x1/2") rectangular ground plate - equivalent surface 3,45 m² (37,1 ft²).

Category: Accessories

Subcategory: Ground plates

Code: RA205



⚓ Earthing or ground plates are a necessary interface between on board electronic devices and the heat sink: water. Glomex earthing plates are made of golden sintered bronze, that is, they consist of a million microspheres creating a surface 10 times bigger than the actual one. They can have either a rectangular or a circular shape, and are fastened to the hull by means of bronze bolts and nuts, highly resistant to corrosion, and rubber spacers. The exclusive shape offered by Glomex assures a larger surface and a better strength.

🇫🇷 Les plaques de masse sont une interface nécessaire entre les dispositifs électroniques de bord et l'élément de dissipation thermique: l'eau. Les plaques de masse Glomex sont faites en bronze doré fritté, c'est-à-dire, qu'elles se composent de millions de microsphères pouvant atteindre une superficie jusqu'à 10 fois supérieure à celle de la plaque. Elles peuvent être de forme rectangulaire ou ronde et sont fixées au-dessous de la coque à l'aide de vis et d'écrous en bronze, hautement résistants à la corrosion, et d'entretoises isolantes en caoutchouc. Sa forme exclusive conçue par Glomex garantit une plus grande superficie et une meilleure résistance.

🇮🇹 Le piastre di messa a terra o di massa sono un'interfaccia necessaria tra i dispositivi elettronici di bordo e il dissipatore di calore: l'acqua. Le piastre di messa a terra Glomex sono realizzate in bronzo sinterizzato dorato, ovvero sono costituite da un milione di microsfeere che creano una superficie 10 volte più grande di quella attuale. Possono avere forma rettangolare o circolare, e sono fissate allo scafo mediante bulloneria in bronzo, altamente resistente alla corrosione, e distanziali in gomma. La forma esclusiva offerta da Glomex assicura una superficie maggiore e una maggiore robustezza.

SUPPLIED ACCESSORIES

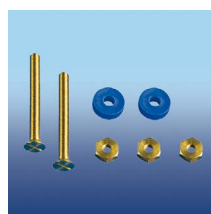

▲ Bronze screws, bolts and nuts

RA207

455x150x13 mm (18x6x1/2") rectangular ground plate - equivalent surface 5,75 m² (61,9 ft²).

Category: Accessories

Subcategory: Ground plates

Code: RA207



🇬🇧 Earthing or ground plates are a necessary interface between on board electronic devices and the heat sink: water. Glomex earthing plates are made of golden sintered bronze, that is, they consist of a million microspheres creating a surface 10 times bigger than the actual one. They can have either a rectangular or a circular shape, and are fastened to the hull by means of bronze bolts and nuts, highly resistant to corrosion, and rubber spacers. The exclusive shape offered by Glomex assures a larger surface and a better strength.

🇫🇷 Les plaques de masse sont une interface nécessaire entre les dispositifs électroniques de bord et l'élément de dissipation thermique: l'eau. Les plaques de masse Glomex sont faites en bronze doré fritté, c'est-à-dire, qu'elles se composent de millions de microsphères pouvant atteindre une superficie jusqu'à 10 fois supérieure à celle de la plaque. Elles peuvent être de forme rectangulaire ou ronde et sont fixées au-dessous de la coque à l'aide de vis et d'écrous en bronze, hautement résistants à la corrosion, et d'entretoises isolantes en caoutchouc. Sa forme exclusive conçue par Glomex garantit une plus grande superficie et une meilleure résistance.

🇮🇹 Le piastra di messa a terra o di massa sono un'interfaccia necessaria tra i dispositivi elettronici di bordo e il dissipatore di calore: l'acqua. Le piastra di messa a terra Glomex sono realizzate in bronzo sinterizzato dorato, ovvero sono costituite da un milione di microsferiche che creano una superficie 10 volte più grande di quella attuale. Possono avere forma rettangolare o circolare, e sono fissate allo scafo mediante bulloneria in bronzo, altamente resistente alla corrosione, e distanziali in gomma. La forma esclusiva offerta da Glomex assicura una superficie maggiore e una maggiore robustezza.

SUPPLIED ACCESSORIES

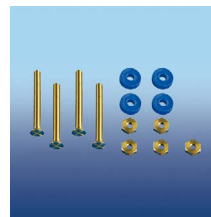

▲ Bronze screws, bolts and nuts



ITAP001

Additional access point for metal/large boat

Category: Accessories

Subcategory: Access points

Code: ITAP001



 150Mbps Wireless N Nano Router Access point, powered through a micro USB port by an external power adapter or USB connection to a computer. It is designed for use with tablets, smart phones, handheld game consoles and other portable electronic wireless devices.

 150Mbps Wireless N Nano Router Point d'accès, alimenté par un port micro USB par un adaptateur d'alimentation externe ou une connexion USB à un ordinateur. Il est conçu pour être utilisé avec des tablettes, des téléphones intelligents, des consoles de jeux portables et d'autres appareils sans fil électroniques portatifs.

 Access point Wireless N Nano Router da 150 Mbps, alimentato tramite una porta micro USB da un adattatore di alimentazione esterno o una connessione USB a un computer. È progettato per l'uso con tablet, smartphone, console di gioco portatili e altri dispositivi wireless elettronici portatili.

OPTIONAL ACCESSORIES



▲ Switch 5-port with auto MDI/MDIX function

ITSW001

Switch 5-port auto MDI/MDIX function

Category: Accessories

Subcategory: desktop switch

Code: ITSW001



 5-Port 10/100Mbps Desktop Switch. It provides an easy way to expand your wired network. It can process data at a rate of up to 200Mbps making it an ideal choice for expanding your high performance wired network. Moreover, all ports support Auto MDI/MDIX function, eliminating the need for crossover cables or Uplink ports.

 5-Port 10/100Mbps Desktop Switch. It provides an easy way to expand your wired network. It can process data at a rate of up to 200Mbps making it an ideal choice for expanding your high performance wired network. Moreover, all ports support Auto MDI/MDIX function, eliminating the need for crossover cables or Uplink ports

 Switch desktop a 5 porte 10/100Mbps. Fornisce un modo semplice per espandere la tua rete cablata. Può elaborare i dati a una velocità fino a 200 Mbps, rendendolo la scelta ideale per espandere la tua rete cablata ad alte prestazioni. Inoltre, tutte le porte supportano la funzione Auto MDI/MDIX, eliminando la necessità di cavi incrociati o porte Uplink.

OPTIONAL ACCESSORIES



▲ Additional access point for metal/large boat



Nomade

24,5x8cm (9.7x3.2") DVB-T2 TV antenna with inner amplifier

Category: DVB-T2 TV antennas

Subcategory: antennas

Code: SGT6000



UK NOMADE is a 24,5 dB gain omnidirectional TV. DVB-T2 /TNT and HDTV antenna for boats and mobile vehicles: it's compact (245mm / 9,7" diameter x 80mm / 3,2" height), light-weight (200g / 7oz) and very easy to be installed also on inclined surfaces thanks to the integrated adjustable mount -15° / +15°.

Designed for low wind resistance, with its low noise built-in amplifier, 5m integrated coax cable and 12V power inserter, it's the best choice to watch TV anytime, anywhere.

FR Nomade est une antenne TV omnidirectionnelle, DVTB/TNT et HDTV, avec un gain de 24,5 dB, pour bateau et véhicules de transports routiers.

Elle est compacte: diamètre de 245mm, hauteur: 80mm, légère, de 200gr, très facile à installer, grâce à son support incliné. C'est le meilleur choix pour regarder la télévision, n'importe où, n'importe quand.

IT Nomade è un'antenna TV digitale omnidirezionale con un guadagno di 24,5 dB, sviluppata per imbarcazioni e veicoli mobili.

È un'antenna dalle dimensioni compatte (245 millimetri / 9,7 "di diametro x 80mm / 3,2 "altezza), leggera (200g / 7 oz) e molto facile da installare anche su superfici inclinate, grazie al supporto integrato regolabile -15 ° / +15 °. Dotata di un amplificatore incorporato a bassa cifra di rumore, di un cavo coassiale integrato di 5m ed un inseritore di alimentazione a 12V, è la scelta migliore per guardare TV sempre e ovunque.

ANTENNA DIAMETER	245mm (9,7")
ANTENNA HEIGHT	80mm (3,2")
BASE DIAMETER INTEGRATED	mounting plate
ANTENNA WEIGHT	200g (7oz)
RADOME	ASA
ANGLE OF RECEPTION	360°
POLARIZATION	Horizontal
IMPEDANCE	75 OHMS
FREQUENCY RANGE	170/890 MHz
GAIN AVERAGE	24.5 dB
NOISE FACTOR	1.7 dB
POWER CONSUPTION	20 mA
POWER SUPPLY	12 Vdc
TV SET	max 1
TERMINATION CABLE + F CONNECTOR	
<i>More info on www.glomex.it</i>	

SUPPLIED ACCESSORIES



▲ SGTPI12V 12 Vdc power inserter



▲ 5m (16.4') coaxial cable



▲ 1,5m (5') TV set cord

Ballade

16,5x7cm (2.8x6.5") DVB-T2 TV antenna with inner amplifier

Category: DVB-T2 TV antennas

Subcategory: antennas

Code: SGT5000



UK BALLADE is a 23,5 dB gain omnidirectional TV DVB-T2 / TNT and HDTV compatible antenna for boats and mobile vehicles: it's super-compact (70 mm / 2,8" diameter x 165mm / 6,5" height), extra light-weight (110g / 4oz) and easy to be installed thanks to the integrated mount.

Powered by low noise built-in amplifier, supplied with 12V power inserter and integrated 5m coax cable, it's the best value for money.

FR Ballade est une antenne TV omnidirectionnelle, DVTB/TNT et HDTV, avec un gain de 23,5 dB, pour bateau et véhicules de transports routiers.

Elle est super compacte: 70mm de diamètre x 165mm de hauteur), extra légère: (110g) et très facile à installer, grâce à son support incliné. Un amplificateur de 12 V et un câble coaxial de 5m sont fournis. C'est un très bon rapport qualité//prix.

IT Ballade è un'antenna TV digitale omnidirezionale con un guadagno di 23,5 dB, sviluppata per imbarcazioni e veicoli mobili. È un'antenna dalle dimensioni estremamente compatte (70 mm / 2,8 "di diametro x 165mm / 6,5" altezza), super leggera (110g / 4oz) e facile da installare grazie al supporto integrato. Dotata di un amplificatore integrato a basso rumore, un inseritore di tensione a 12V e cavo coassiale integrato di 5 m, è l'antenna con il miglior rapporto qualità-prezzo.



ANTENNA DIAMETER	70mm (2,8")
ANTENNA HEIGHT	165mm (6,5")
BASE DIAMETER INTEGRATED	mounting plate
ANTENNA WEIGHT	110g (4oz)
RADOME	material ASA
ANGLE OF RECEPTION	360°
POLARIZATION	Horizontal
IMPEDANCE	75 OHMS
FREQUENCY RANGE	170/890 MHz
GAIN AVERAGE	23.5 dB
NOISE FACTOR	1.7 dB
POWER CONSUPTION	20 mA
POWER SUPPLY	12 Vdc
TV SET	max 1
TERMINATION CABLE + F CONNECTOR	
<i>Maggiori informazioni tecniche sul sito web</i>	

SUPPLIED ACCESSORIES



▲ SGTPI12V 12 Vdc power inserter



▲ 5m (16.4') coaxial cable



▲ 1,5m (5') TV set cord



Task

53cm (21") 3dB VHF antenna with integrated L bracket and 8m coax cable

Category: VHF

Subcategory: 53cm (21")

Code: SGV70RIBBK



- TASK is a 3dB gain VHF antenna designed especially for Rigid Inflatable Boats: it's compact (530mm / 20,9' length) and very easy to be installed thanks to the supplied "L" bracket.

With its black flexible steel whip with helical design to avoid excessive whipping action, and integrated 8m (26') RG58C/U coax cable, it's the best choice for a quick installation and disinstallation.

- Task est une antenne VHF avec un gain de 3 dB, spécialement conçue pour les bateaux gonflables rigides. Elle est compacte (530mm longueur) et très facile à installer grâce à l'équerre en L, fournie.

Avec son fouet flexible en fibre de verre noir et un design torsadé qui freine l'action de fouetter, un câble coaxial de 8m fourni, c'est le meilleur choix pour une installation rapide.

- Task è un'antenna marina VHF con 3dB di guadagno progettata appositamente per i gommoni. È un'antenna compatta (530 millimetri / 20,9 'lunghezza) e molto semplice da installare grazie alla staffa ad "L" integrata.

Dotata di un cavo coassiale integrato RG58C/U di 8m (26') e di uno stilo nero flessibile in acciaio che presenta un design a molla per evitare un eccessivo effetto a "frustata", è la migliore scelta per una rapida installazione e disinstallazione.

FREQUENCY RANGE	156/162 MHz
GAIN AVERAGE	3 dB
IMPEDANCE	50 ohms
POLARIZATION	Vertical
SWR	≤ 1,4 at 156,8 MHz
MAX INPUT POWER	50 W
DC GROUND READS	10K ohms
ANTENNA LENGHT	530mm (20,9")
ANTENNA WEIGHT	125g (4,4oz)
TERMINATION	Cable
<i>More info on www.glomex.it</i>	

SUPPLIED ACCESSORIES



▲ Integrated L bracket



▲ 8 m (26') integrated coax cable

OPTIONAL ACCESSORIES



▲ SGM003BK masthead offset bracket

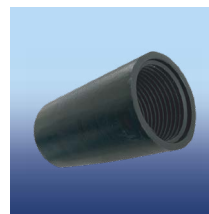

▲ 1"x14 adaptor for any standard mount

Target

53cm (21") 3dB VHF antenna with integrated mount and 8m coax cable

Category: VHF

Subcategory: 53cm (21")

Code: SGV70PBBK



UK TARGET is a 3dB gain VHF antenna designed for any type of boat requiring a short overall length: it's compact (530mm / 20,9' length) and very easy to be installed everywhere thanks to the supplied ratchet mount.

With its black flexible steel whip with helical design to avoid excessive whipping action, and integrated 6m (20') RG58C/U coax cable, it's strong and safe.

FR TARGET est une antenne VHF avec un gain de 3 dB, conçue pour tous type de bateaux nécessitant une longueur globale courte. Elle est très compacte (530mm de longueur), très facile à installer, grâce à son support fourni à cliquet.

Avec son fouet flexible en fibre de verre noir et un design torsadé qui freine l'action de fouetter, un câble coaxial de 6m fourni, c'est le meilleur choix pour une installation rapide.

IT Target è un'antenna marina VHF con un guadagno di 3dB progettata per qualsiasi tipo di imbarcazione. Dalle dimensioni compatte (530 millimetri / 20,9 'lunghezza), è molto facile da installare grazie al supporto integrato.

Dotata di un cavo coassiale integrato RG58C/U di 6m (20') e di uno stilo nero flessibile in acciaio che presenta un design a molla per evitare un eccessivo effetto a "frustata", è un'antenna resistente e sicura.

FREQUENCY RANGE	156/162 MHz
GAIN AVERAGE	3 dB
IMPEDANCE	50 ohms
POLARIZATION	Vertical
SWR	≤ 1,4 at 156,8 MHz
MAX INPUT POWER	50 W
DC GROUND READS	10K ohms
ANTENNA LENGHT	530mm (20,9")
ANTENNA WEIGHT	175g (6,2oz)
TERMINATION	Cable

More info on www.glomex.it

SUPPLIED ACCESSORIES



▲ integrated base



▲ 6 m (20') integrated coax cable



Black swan

85cm (33") 3dB VHF antenna with integrated masthead bracket, wind indicator and 20m coax cable

Category: VHF

Subcategory: 85cm (33")

Code: SGV80BWIBK



BLACK SWAN is a 3dB gain VHF antenna with Wind Indicator designed especially for Sailboat masts to combine communication and information: it's 850mm / 33" height only and very easy to be installed away from other devices thanks to the supplied masthead offset bracket.

With its flexible stainless steel whip and integrated 20m (66') RG58C/U coax cable, it's the best choice to have a good VHF performance with integrated Wind Indicator at the top of the mast.

Black swan est une antenne VHF avec indicateur de vent, un gain de 3 dB, spécialement conçue pour mâts de voiliers pour les communications et les informations. Elle mesure 850mm de longueur seulement et est, très facile à installer grâce à son support spécifique fourni tête de mât.

Avec son fouet flexible noir en acier inoxydable, un câble coaxial RG58C/U de 20m. C'est le meilleur choix pour avoir une bonne performance VHF avec indicateur de vent au sommet du mât.

Black swan è una antenna marine VHF con un di guadagno di 3dB e dotata di un indicatore del vento, progettata in particolare per essere installata sugli alberi delle barche a vela con lo scopo di combinare la comunicazione e l'informazione. Lunga solamente 850 millimetri / 33", è molto facile da installare lontano da altri dispositivi grazie alla staffa offset in dotazione.

Con lo stilo nero in acciaio inox flessibile e il cavo coassiale integrato di 20m (66') RG58C/U, è la scelta migliore per avere una buona prestazione VHF con, inoltre, l'indicatore del vento integrato nella parte superiore del montante.

FREQUENCY RANGE	156/162 MHz
GAIN AVERAGE	3 dB
IMPEDANCE	50 ohms
POLARIZATION	Vertical
SWR	≤ 1,4 at 156,8 MHz
MAX INPUT POWER	50 W
DC GROUND READS	10K ohms
ANTENNA LENGHT	t 850mm (33")
ANTENNA WEIGHT	345g (12,2oz)
TERMINATION	Cable
<i>More info on www.glomex.it</i>	

SUPPLIED ACCESSORIES



▲ masthead offset bracket



▲ 20 m (66') integrated coax cable

OPTIONAL ACCESSORIES

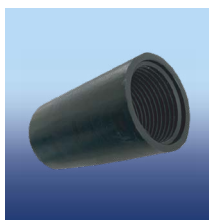

▲ 1"x14 adaptor for any standard mount

Crow

85cm (33") 3dB VHF antenna with integrated L bracket and 20m coax cable

Category: VHF

Subcategory: 85cm (33")

Code: SGV80SBBK



 CROW is a 3dB gain VHF multipurpose antenna designed for any type of boat: it's 860mm / 34" length only and very easy to be installed thanks to the supplied "L" bracket.

With its flexible stainless steel whip and integrated 20m (66') RG58C/U coax cable, it's the right choice to have a good VHF performance on all kind of vessels.

 Crow est une antenne VHF polyvalente avec un gain de 3 dB, conçue pour tous type de bateaux. Elle mesure 860mm de longueur seulement, très facile à installer grâce à son support fourni en L.

Avec son fouet flexible noir en acier inoxydable, un câble coaxial RG58C/U de 20m, c'est le bon choix pour avoir une antenne VHF de performance excellente sur tous les bateaux.

 Crow è un'antenna marina VHF multifunzionale con 3dB di guadagno d'antenna VHF progettata per qualsiasi tipo di imbarcazione. Lunga solamente 860 millimetri / 34", è molto facile da installare grazie alla staffa a "L" in dotazione.

Con lo stilo nero in acciaio inox flessibile ed il cavo coassiale integrato di 20m (66 ') RG58C/U, è la scelta giusta per avere una buona prestazione VHF su tutti i tipi di barche.



FREQUENCY RANGE	156/162 MHz
GAIN AVERAGE	3 dB
IMPEDANCE	50 ohms
POLARIZATION	Vertical
SWR	≤ 1,4 at 156,8 MHz
MAX INPUT POWER	50 W
DC GROUND READS	10K ohms
ANTENNA LENGHT	860 mm (34")
ANTENNA WEIGHT	140gr (5oz)
TERMINATION	Cable

More info on www.glomex.it

SUPPLIED ACCESSORIES



▲ Integrated L bracket



▲ 20 m (66') integrated coax cable

OPTIONAL ACCESSORIES



▲ SGM003BK masthead offset bracket

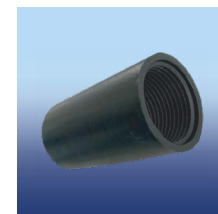

▲ 1"x14 adaptor for any standard mount

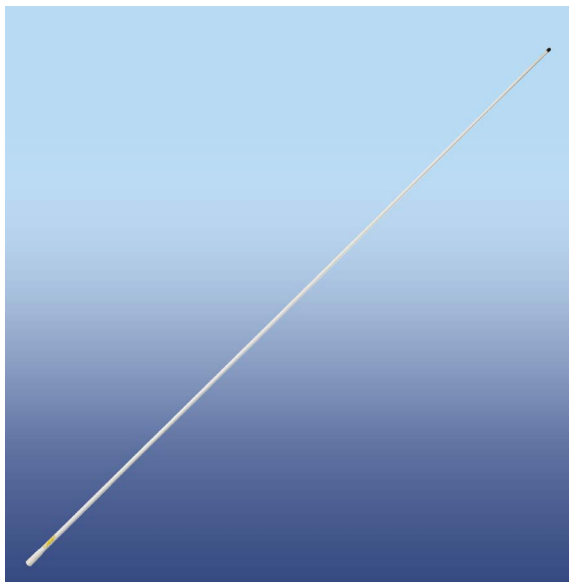

Portofino

2,3m (7.5") 6dB VHF antenna with integrated mount and 6m coax cable

Category: VHF

Subcategory: 2,3m (7.5')

Code: SGV230WH



UK PORTOFINO is a 6dB gain VHF antenna 2,3m / 7,5' length designed for Powerboats and Work Boats: it's lightweight, selfsupporting and very easy to be installed everywhere thanks to the white integrated ratchet mount. With brass and copper elements protected by a strong white fibreglass tube and integrated 6m (20') RG58C/U coax cable, it's the best choice for good VHF communications.

FR Portofino est une antenne VHF avec un gain de 6 dB, pour bateaux à moteur, mesure: 2,3m de longueur, facile à installer, en tous lieux, grâce à un rotule blanc à cliquet fourni. Avec son fouet en fibre de verre blanc et son câble coaxial RG-58C/U fourni de 6m. C'est le meilleur choix pour une bonne communication VHF.

IT Portofino è un'antenna marina VHF con 6dB di guadagno lunga 2,3m / 7,5' progettata per barche a motore e barche da lavoro. E' un'antenna leggera, autoportante e molto facile da installare ovunque grazie al supporto con pomello bianco integrato. Grazie agli elementi in ottone e rame protetti da una canna in fibra di vetro bianca resistente e al cavo coassiale integrato di 6m (20 ') RG58C/U, è la scelta migliore per avere buone comunicazioni VHF.

FREQUENCY RANGE	156/162 MHz
GAIN AVERAGE	6 dB
IMPEDANCE	50 ohms
POLARIZATION	Vertical
SWR	≤ 1,4 at 156,8 MHz
MAX INPUT POWER	50 W
DC GROUND READS	Yes
ANTENNA LENGHT	2,3m (7,5')
ANTENNA WEIGHT	300g (10,6oz)
TERMINATION	Cable
<i>More info on www.glomex.it</i>	

SUPPLIED ACCESSORIES



▲ Integrated base



▲ 20 m (66') integrated coax cable

Elba

97cm (38") 3dB VHF antenna with integrated L bracket and 20m coax cable

Category: VHF

Subcategory: 97cm (38")

Code: SGV100SBBK



🇺🇸 ELBA is a 3dB gain VHF antenna designed for Sailboats: it's 970mm / 38" length and very easy to be installed thanks to the supplied "L" bracket. With its black strong fiberglass whip and integrated 20m (66') RG58C/U coax cable, it's the best choice to have a stable VHF performance under any navigation conditions.

🇫🇷 Elba est une antenne VHF avec un gain de 3 dB, spécialement conçue pour les voiliers. Elle mesure 970mm de longueur, très facile à installer, grâce à son support fourni en L. Avec son fouet en fibre de verre noir et son câble coaxial RG-58C/U fourni de 20m. C'est le meilleur choix pour une antenne VHF pour une navigation en toutes conditions.

🇮🇹 Elba è una antenna marina VHF con 3dB di guadagno, sviluppata per le barche a vela. Lunga 970 millimetri / 38", è molto facile da installare grazie alla staffa a "L" in dotazione. Dotata di uno stilo in fibra di vetro nero e di un cavo coassiale integrato di 20m (66') RG58C/U, è la scelta migliore per avere un rendimento stabile di funzionamento in qualsiasi condizioni di navigazione.

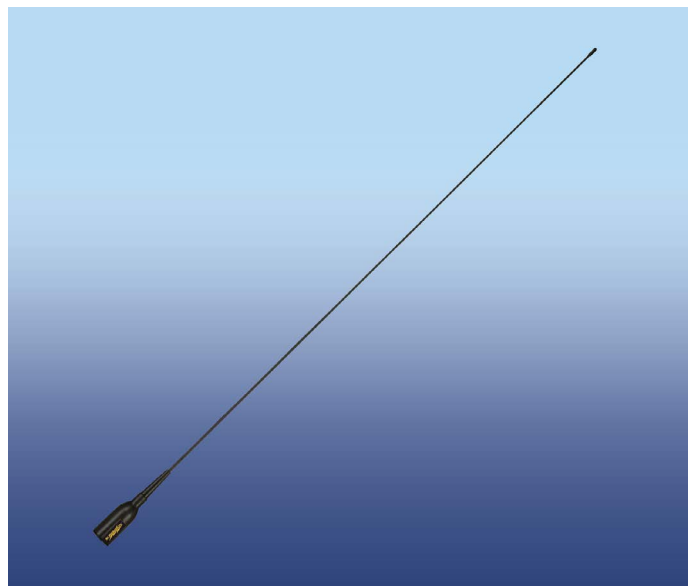

FREQUENCY RANGE	156/162 MHz
GAIN AVERAGE	3 dB
IMPEDANCE	0 ohms
POLARIZATION	Vertical
SWR	≤ 1,4 at 156,8 MHz
MAX INPUT POWER	50 W
DC GROUND READS	10K ohms
ANTENNA LENGHT	970mm (38")
ANTENNA WEIGHT	175g (6,2oz)
TERMINATION	Cable
<i>More info on www.glomex.it</i>	

SUPPLIED ACCESSORIES



▲ Integrated L bracket



▲ 20 m (66') integrated coax cable

OPTIONAL ACCESSORIES



▲ SGM003BK masthead offset bracket

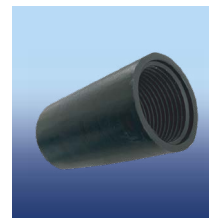

▲ 1"x14 adaptor for any standard mount



Ibiza

1,4m (4.5") 3dB VHF antenna with integrated mount and 6m coax cable

Category: VHF

Subcategory: 1,4m (4.5')

Code: SGV140BK



IBIZA is a 3dB gain VHF antenna 1,4m / 4,5' length designed for Powerboats and Work Boats: it's lightweight and very easy to be installed everywhere thanks to the black integrated ratchet mount. With brass and copper elements protected by a strong black fibreglass tube and integrated 6m (20') RG58C/U coax cable, it's the best value for money.

IBIZA est une antenne VHF de 3 dB, 1,4m de longueur, conçue pour bateaux à moteur et de marchandises. Elle est légère et très facile à installer, en tous lieux, grâce à un rotule noir à cliquet fourni. Avec son fouet en fibre de verre noir flexible et son câble coaxial RG-58C/U fourni de 6m, c'est le meilleur rapport qualité prix.

Ibiza è un'antenna marina VHF con un guadagno di 3dB e una lunghezza di 1,4 m / 4,5' sviluppata per barche a motore e imbarcazioni da lavoro. È un'antenna leggera e molto facile da installare ovunque grazie al supporto con pomello nero integrato. Grazie agli elementi in ottone e rame protetti da una canna in fibra di vetro nero resistente e al cavo coassiale integrato di 6m (20') RG58C/U, è un'antenna con il miglior rapporto qualità-prezzo.

FREQUENCY RANGE	156/162 MHz
GAIN AVERAGE	3 dB
IMPEDANCE	50 ohms
POLARIZATION	Vertical
SWR	≤ 1,4 at 156,8 MHz
MAX INPUT POWER	50 W
DC GROUND READS	Yes
ANTENNA LENGHT	1,4m (4,5')
ANTENNA WEIGHT	230g (8,1oz)
TERMINATION	Cable
<i>More info on www.glomex.it</i>	

SUPPLIED ACCESSORIES



▲ Integrated base



▲ 6 m (20') integrated coax cable

Capri

1,4m (4.5") 3dB VHF antenna with integrated mount and 6m coax cable

Category: VHF

Subcategory: 1,4m (4.5')

Code: SGV140WH



🇬🇧 CAPRI is a 3dB gain VHF antenna 1,4m / 4,5' length designed for Powerboats and Work Boats: it's lightweight and very easy to be installed everywhere thanks to the white integrated ratchet mount. With brass and copper elements protected by a strong white fibreglass tube and integrated 6m (20') RG58C/U coax cable, it's the best value for money.

🇫🇷 Capri est une antenne VHF de 3dB, mesure 1,4m de longueur, pour bateaux à moteur et marchandises. Elle est légère et très facile à installer, en tous lieux, grâce à un rotule blanc à cliquet fourni. Avec son fouet en fibre de verre blanc et son câble coaxial RG-58C/U fourni de 6m, c'est le meilleur rapport qualité prix.

🇮🇹 Capri è un'antenna marina VHF con un guadagno di 3dB ed una lunghezza di 1,4 m / 4,5 ' progettata per le barche a motore e le imbarcazioni da lavoro. È un'antenna leggera e molto facile da installare ovunque grazie al supporto con pomello bianco integrato. Grazie agli elementi in ottone e rame protetti da una canna in fibra di vetro bianca resistente e al cavo coassiale integrato di 6m (20 ') RG58C/U, è l'antenna con il miglior rapporto qualità-prezzo.

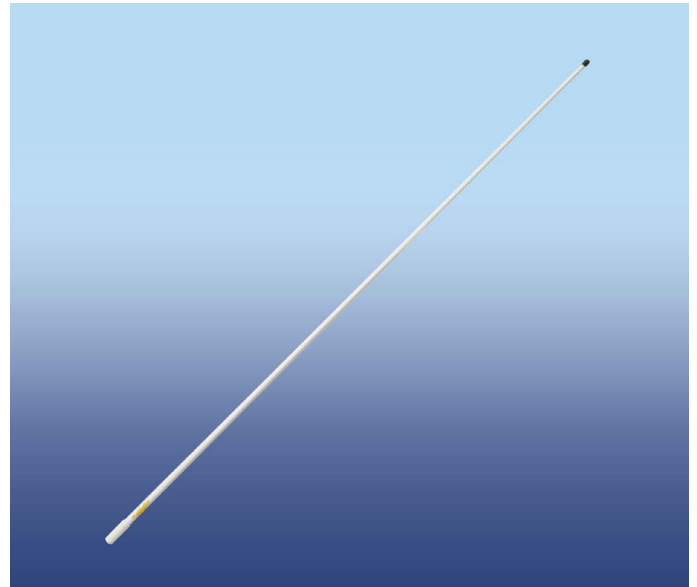

FREQUENCY RANGE	156/162 MHz
GAIN AVERAGE	3 dB
IMPEDANCE	50 ohms
POLARIZATION	Vertical
SWR	≤ 1,4 at 156,8 MHz
MAX INPUT POWER	50 W
DC GROUND READS	Yes
ANTENNA LENGHT	1,4m (4,5')
ANTENNA WEIGHT	230g (8,1oz)
TERMINATION	Cable
<i>More info on www.glomex.it</i>	

SUPPLIED ACCESSORIES



▲ Integrated base



▲ 20 m (66') integrated coax cable



Target FM

53cm (21") FM antenna with integrated mount and 6m coax cable

Category: FM

Subcategory: 53cm (21")

Code: SGR70PBBK



🇬🇧 The FM is a common VHF transmission mode. FM band is less prone to disturbances and interferences assuring a clear reception of signals. FM antennas are often used to listen to radio stations also during navigation. TARGET FM is a FM antenna designed for any type of boat requiring a short overall length: it's compact (530mm / 20,9' length) and very easy to be installed everywhere thanks to the supplied ratchet mount. With its black flexible steel whip with helical design to avoid excessive whipping action, and integrated 6m (20') RG62 coax cable, it's strong and safe.

🇫🇷 TARGET FM est une antenne FM, conçue pour tous type de bateaux nécessitant une longueur globale courte. Elle est très compacte (530mm de longueur), très facile à installer, grâce à son support fourni à cliquet. Avec son fouet flexible en fibre de verre noir et un design torsadé qui freine l'action de fouetter, un câble coaxial de 6m fourni, c'est le meilleur choix pour une installation rapide.

🇮🇹 Target FM è un'antenna marina FM progettata per qualsiasi tipo di imbarcazione. Dalle dimensioni compatte (530 millimetri / 20,9 'lunghezza), è molto facile da installare grazie al supporto integrato. Dotata di un cavo coassiale integrato RG62 di 6m (20') e di uno stilo nero flessibile in acciaio che presenta un design a molla per evitare un eccessivo effetto a "frustata", è un'antenna resistente e sicura.

FREQUENCY RANGE	88/108 MHz
IMPEDANCE	82 ohms
POLARIZATION	Vertical
DC GROUND READS	10K ohms
ANTENNA LENGHT	530mm (20,9")
ANTENNA WEIGHT	175g (6,2oz)
TERMINATION	Cable with Motorola plug
<i>More info on www.glomex.it</i>	

SUPPLIED ACCESSORIES



▲ integrated base



▲ 6 m (20') integrated coax cable

Madeira

2,3m (7.5") 6dB VHF antenna with integrated mount and 6m coax cable

Category: VHF

Subcategory: 2,3m (7.5')

Code: SGV230BK



MADEIRA is a 6dB gain VHF antenna 2,3m / 7,5' length designed for Powerboats and Work Boats: it's lightweight, selfsupporting and very easy to be installed everywhere thanks to the black integrated ratchet mount. With brass and copper elements protected by a strong white fibreglass tube and integrated 6m (20') RG58C/U coax cable, it's the best choice for good VHF communications.

MADEIRA est une antenne VHF de 3 dB, 2,3m de longueur, conçue pour bateaux à moteur et de marchandises, Elle est légère et très facile à installer, en tous lieux, grâce à son rotule noir à cliquet fourni. Avec son fouet en fibre de verre noir flexible et son câble coaxial RG-58C/U fourni de 6m, c'est le meilleur choix pour une bonne communication en VHF.

Madeira è un'antenna marina VHF con 6dB di guadagno ed una lunghezza di 2,3 m / 7,5' sviluppata per le barche a motore e le imbarcazioni da lavoro. Leggera e autoportante è molto facile da installare ovunque grazie al supporto con pomello nero integrato. Grazie agli elementi in ottone e rame protetti da una canna in fibra di vetro nera resistente e al cavo coassiale integrato di 6m (20') RG58C/U, è la scelta migliore per avere buone comunicazioni VHF.

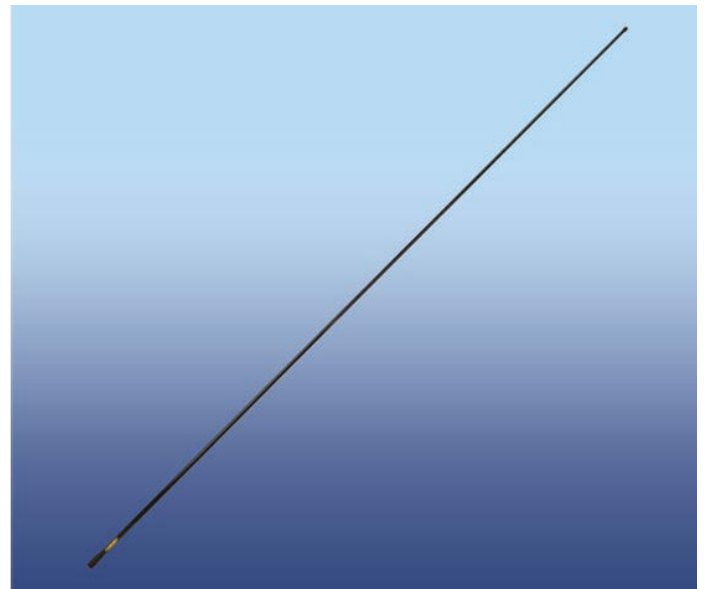

FREQUENCY RANGE	156/162 MHz
GAIN AVERAGE	6 dB
IMPEDANCE	50 ohms
POLARIZATION	Vertical
SWR	≤ 1,4 at 156,8 MHz
MAX INPUT POWER	50 W
DC GROUND READS	Yes
ANTENNA LENGTH	2,3m (7,5')
ANTENNA WEIGHT	300g (10,6oz)
TERMINATION	Cable

More info on www.glomex.it

SUPPLIED ACCESSORIES



▲ Integrated base



▲ 6 m (20') integrated coax cable

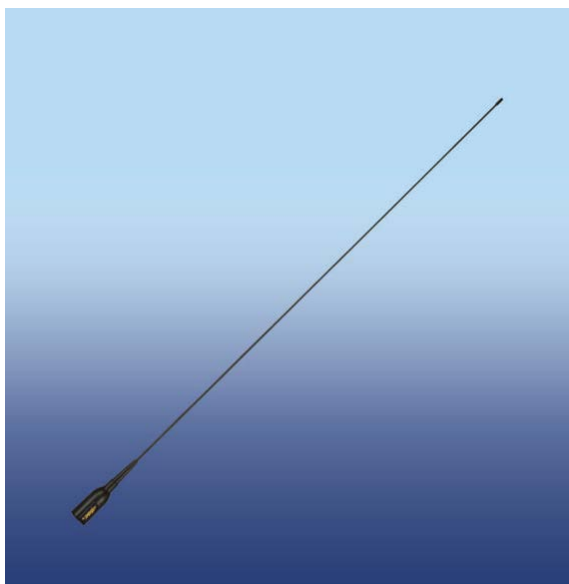

Elba AIS

97cm (38") AIS antenna with integrated L bracket and 20m coax cable

Category: AIS

Subcategory: 97cm (38")

Code: SGA100SBBK



🇬🇧 The Automatic Identification System (AIS) is a monitoring system of naval traffic, useful for navigation safely with difficult meteorological conditions (fog or nocturnal navigation). The AIS system operates on 2 expressly dedicated VHF channels (161.975 and 162.025 MHz) and allows the user to receive real time information about the traffic in the surrounding area. ELBA AIS is a 3dB gain AIS antenna designed for Sailboats: it's 970 mm / 38" length and very easy to be installed thanks to the supplied "L" bracket. With its black strong fiberglass whip and integrated 20m (66') RG58C/U coax cable, it's the best choice to have a stable AIS performance under any navigation conditions.

🇮🇹 Elba AIS est une antenne AIS avec un gain de 3 dB, spécialement conçue pour les voiliers. Elle mesure 970mm/38 de longueur, très facile à installer, grâce à son support fourni en L. Avec son fouet en fibre de verre noir et son câble coaxial fourni de 20m (66) RG58CU. C'est le meilleur choix pour une antenne AIS pour une navigation en toutes conditions .

🇮🇹 Elba AIS è una antenna marina AIS con 3dB di guadagno, sviluppata per le barche a vela. Lunga 970 millimetri / 38", è molto facile da installare grazie alla staffa a "L" in dotazione. Dotata di uno stilo in fibra di vetro nero e di un cavo coassiale integrato di 20m (66 ') RG58C/U, è la scelta migliore per avere un rendimento stabile di funzionamento in qualsiasi condizioni di navigazione.

OPTIONAL ACCESSORIES

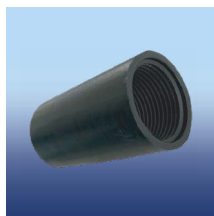

▲ 1"x14 adaptor for any standard mount

SUPPLIED ACCESSORIES



▲ Integrated L bracket



▲ 20 m (66') integrated coax cable

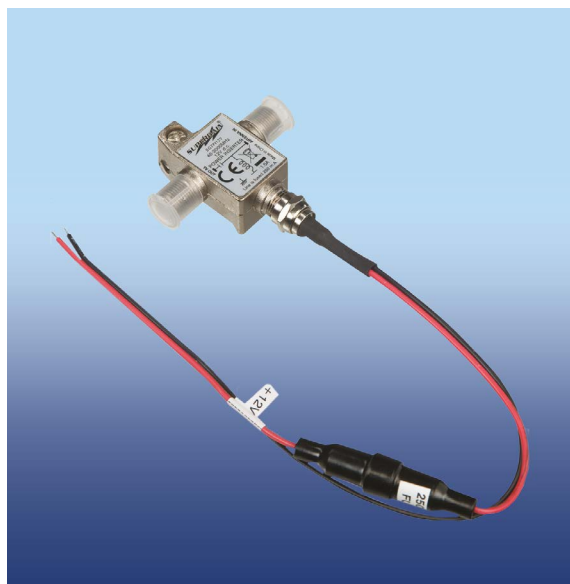

SGTPI12V

12 Vdc power inserter

Category: DVB-T2 TV antennas

Subcategory: Accessories

Code: SGTPI12V

🇬🇧 12 Vdc power inserter

🇮🇹 Inseriteur d'alimentation 12 Vdc

🇮🇹 Inseritore di tensione 12 Vdc

Task FM

53cm (21") FM antenna with integrated L bracket and 6m coax cable

Category: FM

Subcategory: 53cm (21")

Code: SGR70RIBBK



🇺🇸 The FM is a common VHF transmission mode. FM band is less prone to disturbances and interferences assuring a clear reception of signals. FM antennas are often used to listen to radio stations also during navigation. TASK FM is a FM antenna designed especially for Rigid Inflatable Boats: it's compact (530mm / 20,9' length) and very easy to be installed thanks to the supplied "L" bracket. With its black flexible steel whip with helical design to avoid excessive whipping action, and integrated 8m (26') RG62 coax cable, it's the best choice for a quick installation and disintallation.

🇫🇷 Task FM est une antenne FM, spécialement conçue pour les bateaux gonflables rigides. Elle est compacte (530mm longueur) et très facile à installer grâce à l'équerre L fournie. Avec son fouet flexible en fibre de verre noir et un design torsadé qui freine l'action de fouetter, un câble coaxial de 8m fourni, c'est le meilleur choix pour une installation rapide.

🇮🇹 Task FM è un'antenna marina FM progettata appositamente per i gommoni. È un'antenna compatta (530 millimetri / 20,9 'lunghezza) e molto semplice da installare grazie alla staffa ad "L" integrata. Dotata di un cavo coassiale integrato RG62 di 8m (26') e di uno stilo nero flessibile in acciaio che presenta un design a molla per evitare un eccessivo effetto a "frustata", è la migliore scelta per una rapida installazione e disinstallazione.



FREQUENCY RANGE	88/108 MHz
IMPEDANCE	Impedance 82 ohms
POLARIZATION	Vertical
DC GROUND READS	10K ohms
ANTENNA LENGHT	530mm (20,9")
ANTENNA WEIGHT	125g (4,4oz)
TERMINATION	Cable with Motorola plug

More info on www.glomex.it

SUPPLIED ACCESSORIES



▲ Integrated L bracket

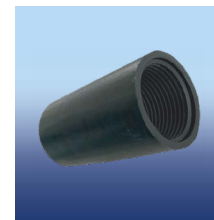

▲ 1"x14 adaptor for any standard mount



▲ 8 m (26') integrated coax cable



SGVPL259

PL-259 connector for RG58 coax cable

Category: Accessories

Code: SGVPL259



 PL-259 connector for RG58 coax cable

 connecteur PL-259 pour câble coaxial RG-58

 connettore PL-259 per cavo coassiale RG-58



SGVCX100

100m (328') RG58 low loss coax cable

Category: Accessories

Code: SGVCX100



 100m (328') RG58 low loss coax cable

 100m câble coaxial à faible perte RG-58

 cavo coassiale RG-58 a bassa perdita da 100m

SGM002BK

L bracket

Category: Accessories

Code: SGM003BK



🇬🇧 Aluminium L bracket for Supergain antennas codes SGV70./SGV80./SGV100.



🇫🇷 Support L en aluminium pour antennes Supergain codes SGV70./SGV80./SGV100.

🇮🇹 Staffa ad L in alluminio per antenne Supergain con codice SGV70../SGV80../SGV100.

SGM003BK

Masthead offset bracket

Category: Accessories

Code: SGM003BK



🇬🇧 Aluminium masthead offset bracket



🇫🇷 Support pour tête de mât en aluminium.

🇮🇹 Staffa per testa d'albero in alluminio



GLOMEX[®]
The best in marine antennas



since 1984

Glomex S.p.A.
Via Faentina 165/G, 48124, Ravenna (Italy)
+39 0544 500377 • info@glomex.it

WWW.GLOMEX.IT



OTTOBRE 2023