



MARINE  
EMERGENCY VEHICLE  
INDUSTRIAL  
RV

2024

# NAVICO GROUP

## TAKING YOU FURTHER

Navico Group is the world's leading supplier of integrated systems and products to industries ranging from marine to recreational vehicle and beyond. We offer an unmatched portfolio comprised of industry-leading brands in power management, digital control & monitoring, networked devices and marine electronics.

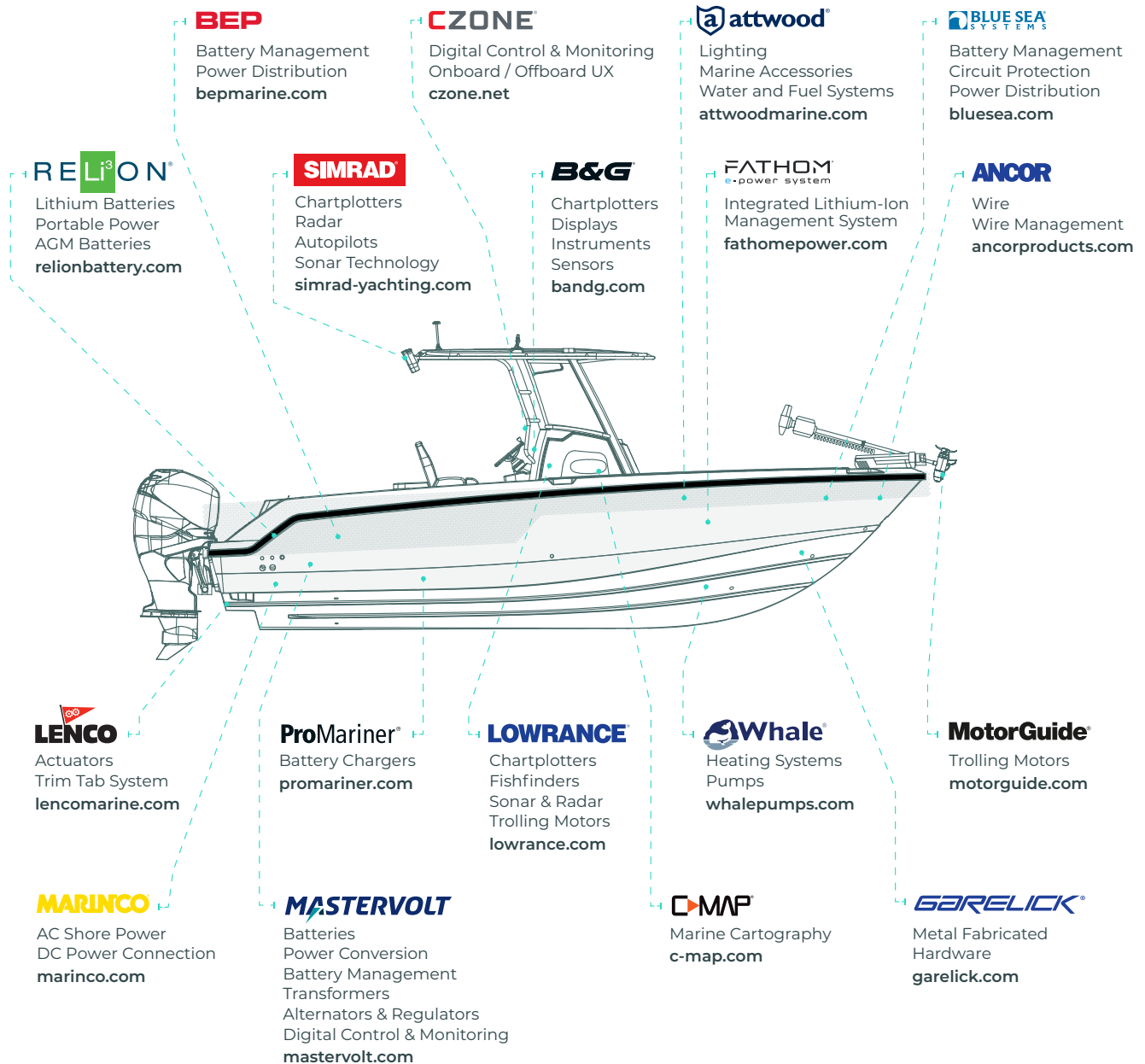

See how far our innovations can take you at [Navico.com](http://Navico.com)



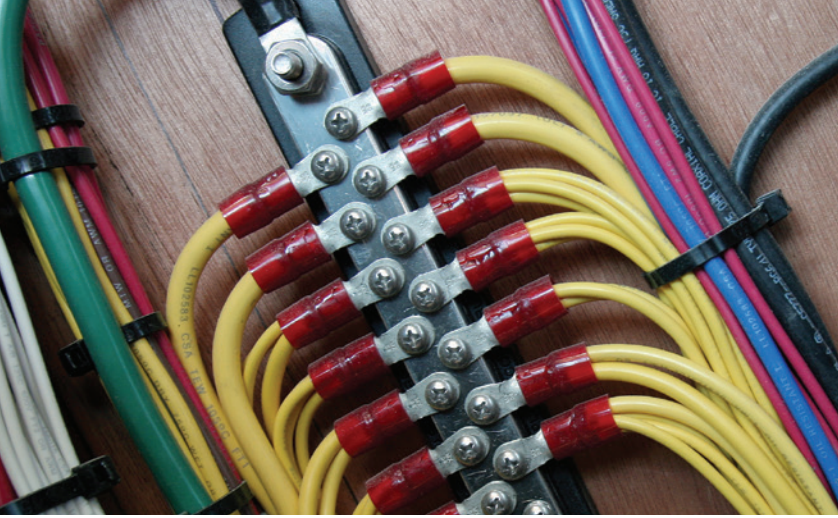

# What makes Blue Sea Systems different:

## Founder's Vision

Blue Sea Systems was founded in 1992 based on a commitment to create innovative, high quality electrical products to improve the safety, simplicity, and reliability of boating. Since that time the range of product has expanded to over 1,000 items and distributed to customers in over 50 countries including Marine, Industrial, RV, and Specialty Vehicle markets. Products include battery chargers, battery switches, automatic charging relays, fuse blocks, busbars, meters, and both standard and custom power distribution panels. The company is committed to offering quality products that are engineered for the harsh marine environment, built to last, with a guarantee of satisfaction and industry leading technical support.

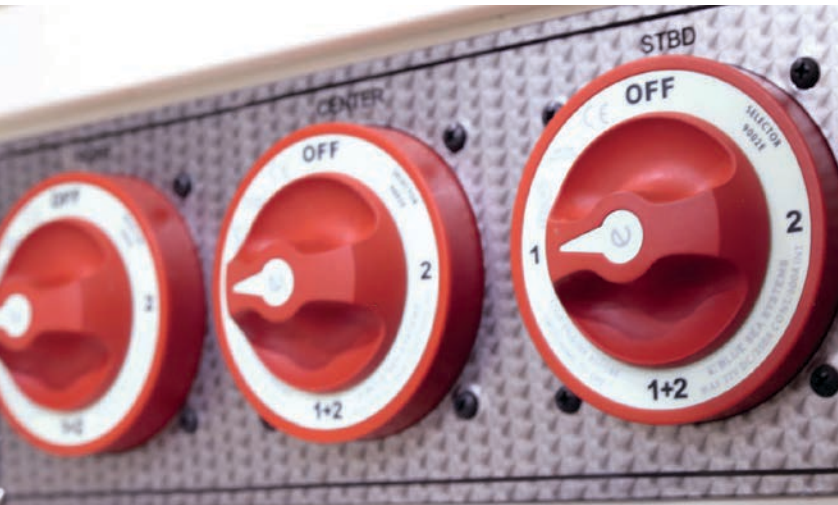

## Selection

Over 1,000 electrical products are designed to work together as a fully integrated system



## Fast Delivery

Just in time manufacturing for many products in Bellingham, Washington ensures rapid order fulfillment

## Worldwide Access to Product

A distribution network in over 50 countries provides access to products when they are needed

## Information

24-hour access to product information, selection tools, and technical articles online at [blueseasystems.com](http://blueseasystems.com)

## Industry Standards

Industry involvement ensures products meet ABYC, NMMA, and Coast Guard standards

## Quality

Blue Sea Systems is committed to product quality and is managed in a manner consistent with international business practices with a robust product warranty program.



# Table of Contents

## Introduction

System Diagrams	6
-----------------	---

## Power Conversion & Connection

Air Brake Compressors	18
P12 Charger	19
P12 Charger Remote	20
EV Remote Display	20
Sure Eject™	21
BatteryLink® Chargers	22
Dual USB Chargers	24
12V Socket & Plug System	25
Water-Resistant Accessory Panels	26
DeckHand Dimmers	27



p. 18



p. 19



p. 20



p. 21



p. 22



p. 24



p. 25



p. 26



p. 27

## Battery Management

Manual Battery Switches	30, 36
Battery Management Panels	38
Solenoid Switches	39, 52
Low Voltage Disconnect	40, 53
Automatic Timer Disconnect	41, 53
Remote Battery Switches	43, 52
Automatic Charging Relays	46, 50, 53
Add-A-Battery Kits	48



p. 30



p. 38



p. 39



p. 40



p. 41



p. 43



p. 46



p. 48

## Circuit Protection & Switches

Fuses	56, 72
Fuse Holders	60, 72
Fuse Blocks	61, 73
Circuit Breaker Blocks	74
Circuit Breakers	75, 90
Surface Mount System	88
Switches	92



p. 57



p. 60



p. 61



p. 74



p. 75



p. 77



p. 88



p. 92

## Connectors & Insulators

BusBars	100
Terminal Blocks	103
PowerBars	104
PowerPost Connectors	106
Feed Through Connectors	106
CableCaps	108
CableClams	109



p. 100



p. 101



p. 103



p. 104



p. 106



p. 108



p. 109



## Power Distribution

Waterproof & Water-Resistant	112, 113
Contura Switch Water-Resistant	112, 113
WeatherDeck® Waterproof	112, 115
360 Panel System	116
Traditional Metal	117
DC Branch Circuit Breaker	118
AC Main Circuit Breaker	122
AC Branch Circuit Breaker	124
AC RCBO Circuit Breaker	126
AC Source Selection	127
AC/DC Combination	130
Custom 360	132



p. 113



p. 114



p. 116



p. 117



p. 118



p. 122



p. 126



p. 127



p. 130



p. 132

## Meters

Analog Meters	140, 148
M2 OLED Digital Meters	142, 148
M2 OLED Vessel Systems Monitor	142, 148
Mini OLED Meters	145, 148
Mini Clamp Multimeter	145, 148
Digital Meters	146, 148
DC Shunts	149
Temperature Sensor	149
AC Transformers	149



p. 140



p. 142



p. 145



p. 145



p. 146



p. 149



p. 149



p. 149

## Accessories

Floyd Bell Turbo Series Alarm	152
Insulating Back Covers	152
120V AC Dual Outlet	152
LED Indicators	153
Lockout Slides	153
Toggle Guard	153
Labels	154, 158



p. 152



p. 152



p. 152



p. 153



p. 153



p. 153



p. 154

## Appendix & Index

Wire Selection Chart	159
Fuse Selection Chart	160
Fuse Holder Selection Chart	161
Wiring Schematics	162
DC Discussion	164
AC Discussion	165
Part Number Index	166

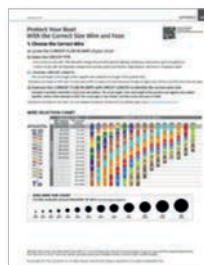

p. 159

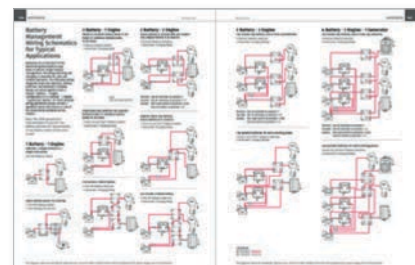

p. 162





# Trailable Boat System

2 Battery Bank, 1 Engine

AC Current → DC Current →

## AC SOURCE



SHORE POWER

## DC SOURCES



HOUSE



ENGINE

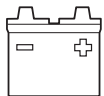

ENGINE



**m-Series Battery Switch**  
6011 (p. 30)



**Safety Fuse Block**  
7720 (p. 70)



**285 Series Circuit Breaker**  
7187 (p. 78)



**BatteryLink® Charger**  
7605 (p.22)



**M2 OLED SoC Monitor**  
1830 (p. 142)



**MRBF Terminal Fuse Block**  
5191 (p. 68)



**Mini OLED Tank Meter**  
1739200 (p. 145)



**Mini OLED Temp Meter**  
1741200 (p. 145)



**ST-Blade Split Bus Fuse Block**  
5032 (p. 65)

Switched Circuits

24-Hour Circuits

The diagram above is intended for reference only. Consult an electrical professional for system design and circuit protection.



# DC LOADS

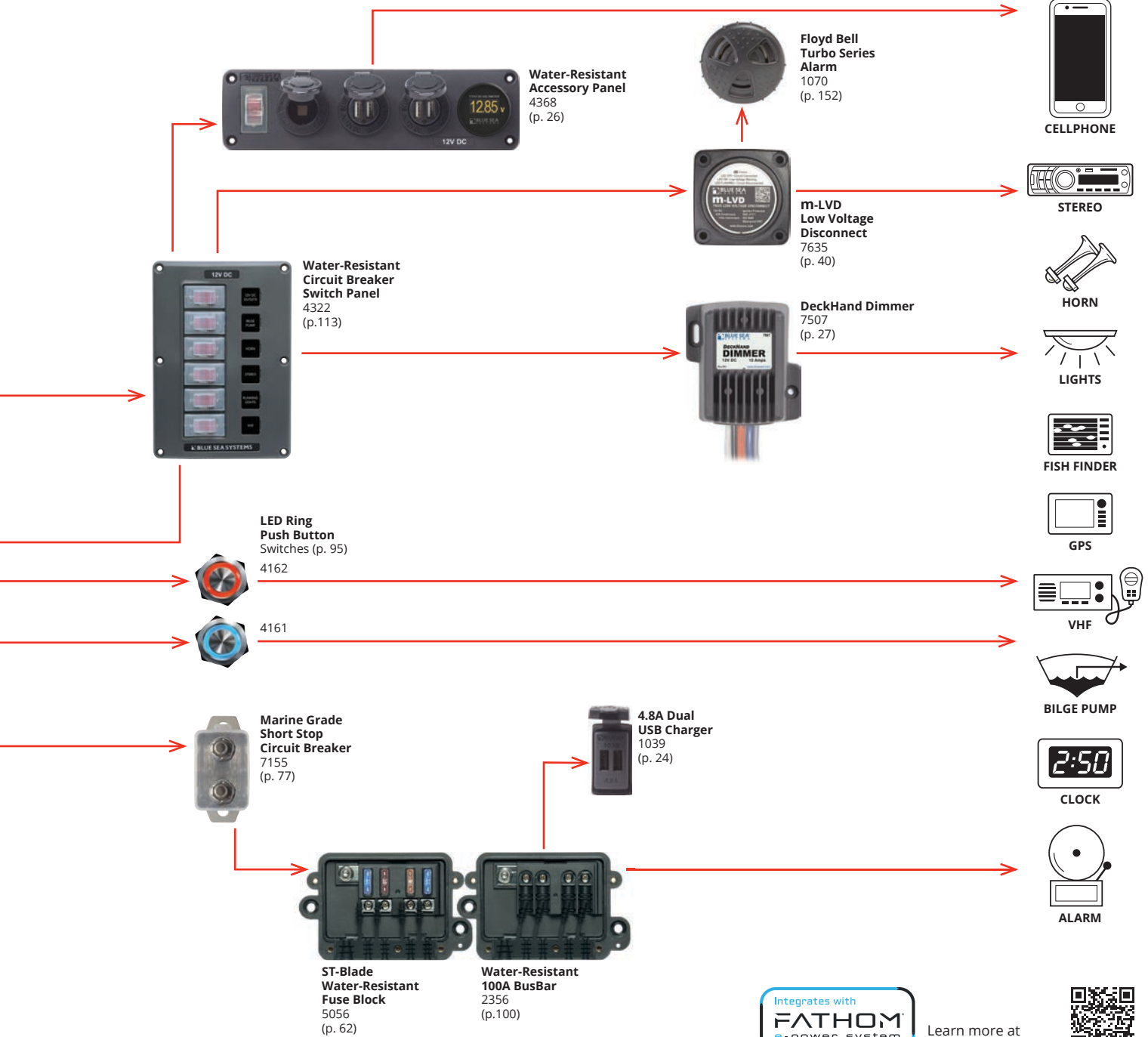

Learn more at [fathomepower.com](http://fathomepower.com)



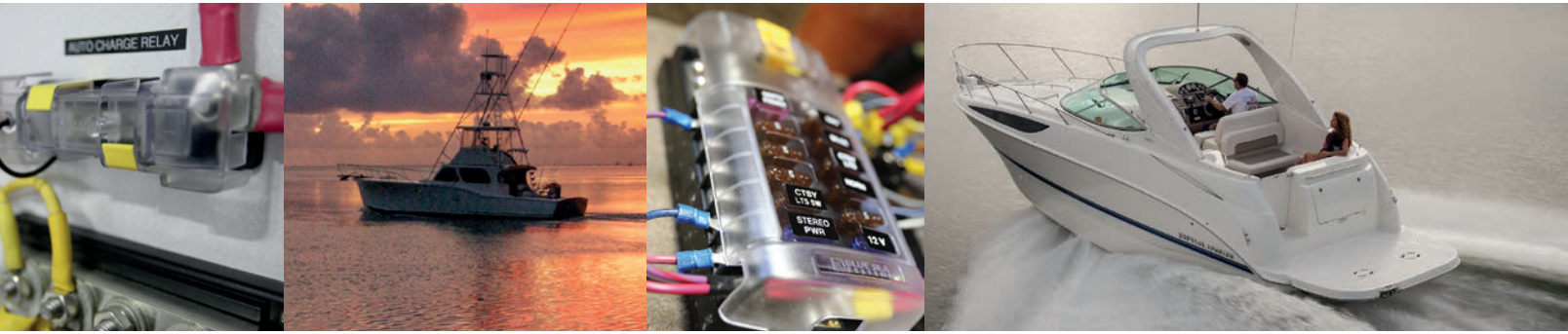

# Yacht System

3 Battery Bank, 1 Engine

AC Current → DC Current →

## AC SOURCES

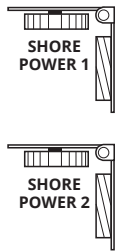

SMS Surface Mount System 3117 (p. 88)



AC/DC 360 Custom Panel (p. 132)



## DC SOURCES

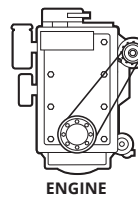

Alternator

Start

ENGINE

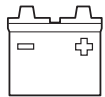

ENGINE



P12 LED Remote 7520 (p. 20)



P12 Battery Charger 7532 (p. 19)

ML-Series Remote Battery Switch 7700 (p. 43)

ML-Series Automatic Charging Relay 7620 (p. 51)

ML-Series Remote Battery Switch 7700 (p. 43)



MRBF Terminal Fuse Block 5191 (p. 68)



SI-ACR Automatic Charging Relay 7610 (p. 47)



MRBF FuseBlock 5194 (p. 68)



Stud Mount Insulating Boots 4000 (p. 108)

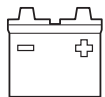

HOUSE

MRBF Terminal Fuse Block 5191 (p. 68)



Safety Fuse Block 7720 (p. 70)

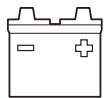

AUXILIARY

Class-T Fuse Block 5502100 (p. 69)

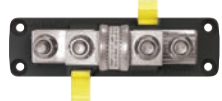

PowerBar 1000 1990 (p. 104)

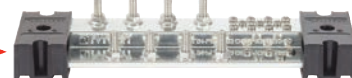

The diagram above is intended for reference only. Consult an electrical professional for system design and circuit protection.





# AC LOADS



OUTLETS



MICROWAVE

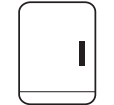

REFRIGERATOR

# DC LOADS



HORN



RUNNING LIGHTS



CABIN LIGHTS



GPS



VHF



STEREO

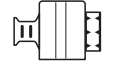

WINDLASS

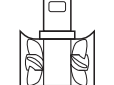

BOW THRUSTER



**M2 OLED Vessel Systems Monitor 1850**  
(p. 142)



**WeatherDeck® Waterproof Panel 4306**  
(p. 115)



**Water-Resistant USB Accessory Panel 4366**  
(p. 26)



**ST-Blade Split Bus Fuse Block 5032**  
(p. 65)

Switched Circuits

24-Hour Circuits



**Backlit Push Button Switches 4180**  
(p. 95)



4180 (p. 95)



**4.8A Dual USB Charger 1045**  
(p. 24)

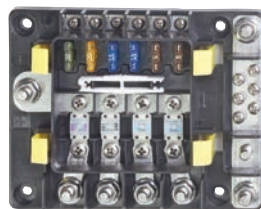

**SafetyHub Fuse Block 7748**  
(p. 71)



**E-Series Battery Switch 9004E**  
(p. 32)





# Van System

2 Battery Bank, 1 Engine

AC Current → DC Current →

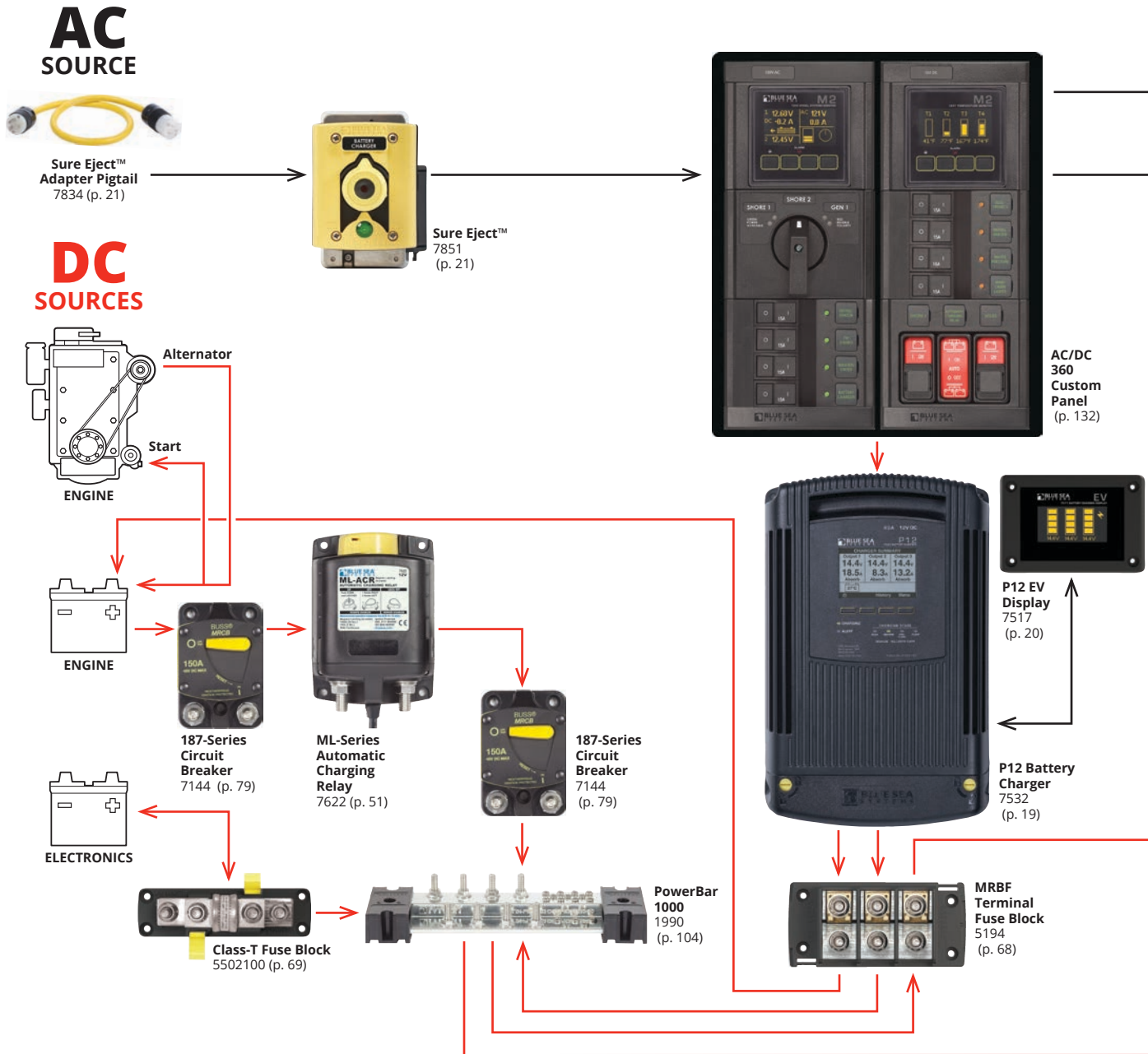

The diagram above is intended for reference only. Consult an electrical professional for system design and circuit protection.

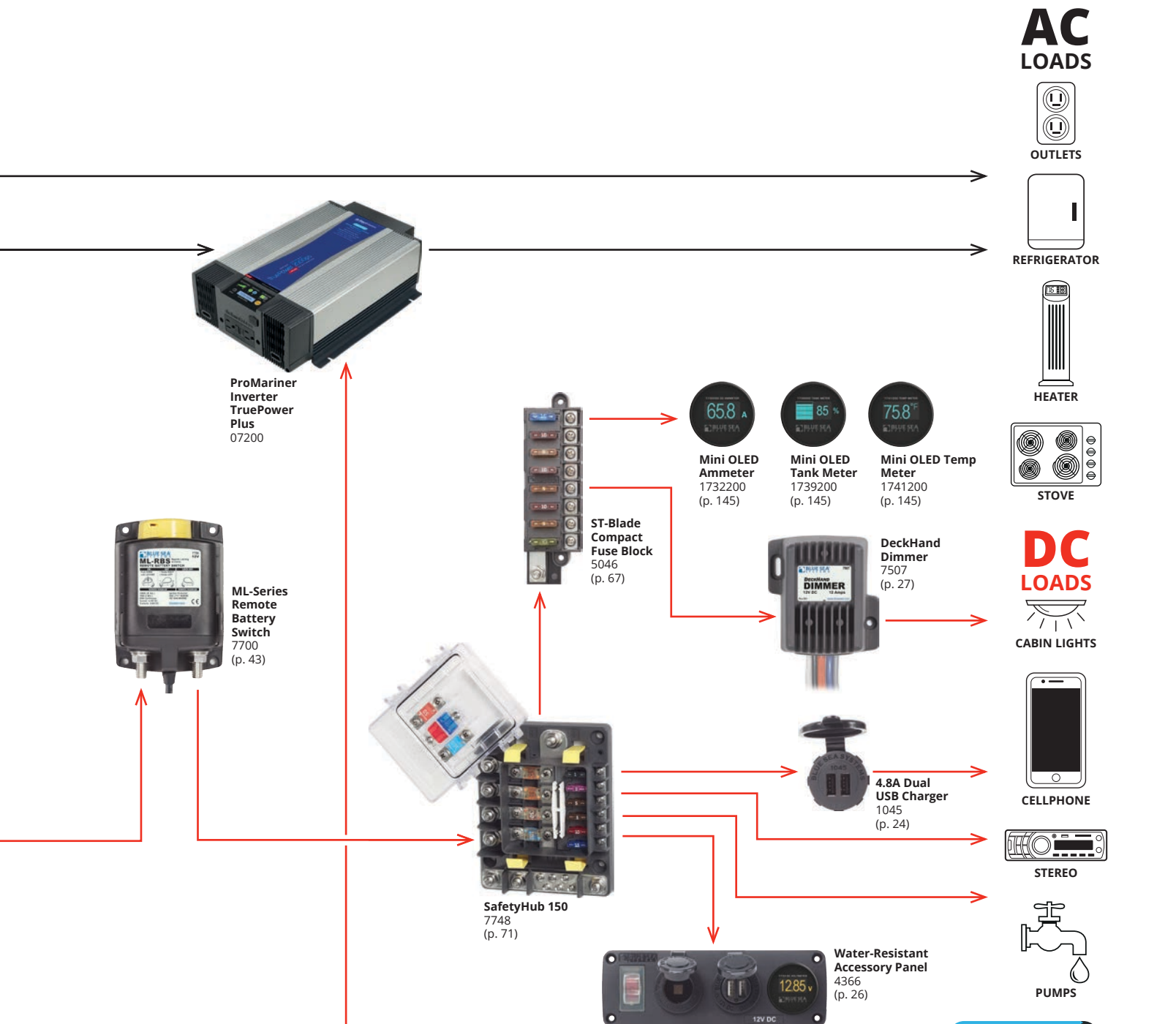

### AC LOADS



OUTLETS



REFRIGERATOR

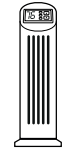

HEATER

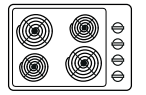

STOVE

### DC LOADS



CABIN LIGHTS

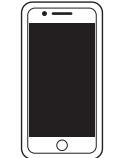

CELLPHONE



STEREO



PUMPS



ProMariner Inverter TruePower Plus 07200



ML-Series Remote Battery Switch 7700 (p. 43)



ST-Blade Compact Fuse Block 5046 (p. 67)



Mini OLED Ammeter 1732200 (p. 145)



Mini OLED Tank Meter 1739200 (p. 145)



Mini OLED Temp Meter 1741200 (p. 145)



DeckHand Dimmer 7507 (p. 27)



4.8A Dual USB Charger 1045 (p. 24)

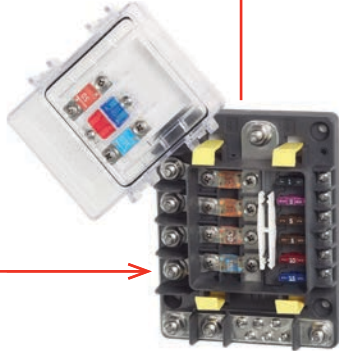

SafetyHub 150 7748 (p. 71)



Water-Resistant Accessory Panel 4366 (p. 26)



Integrates with FATHOM e-power system





# Interceptor/Battalion Chief Vehicle

2 Battery Bank, 1 Engine

AC Current → DC Current →

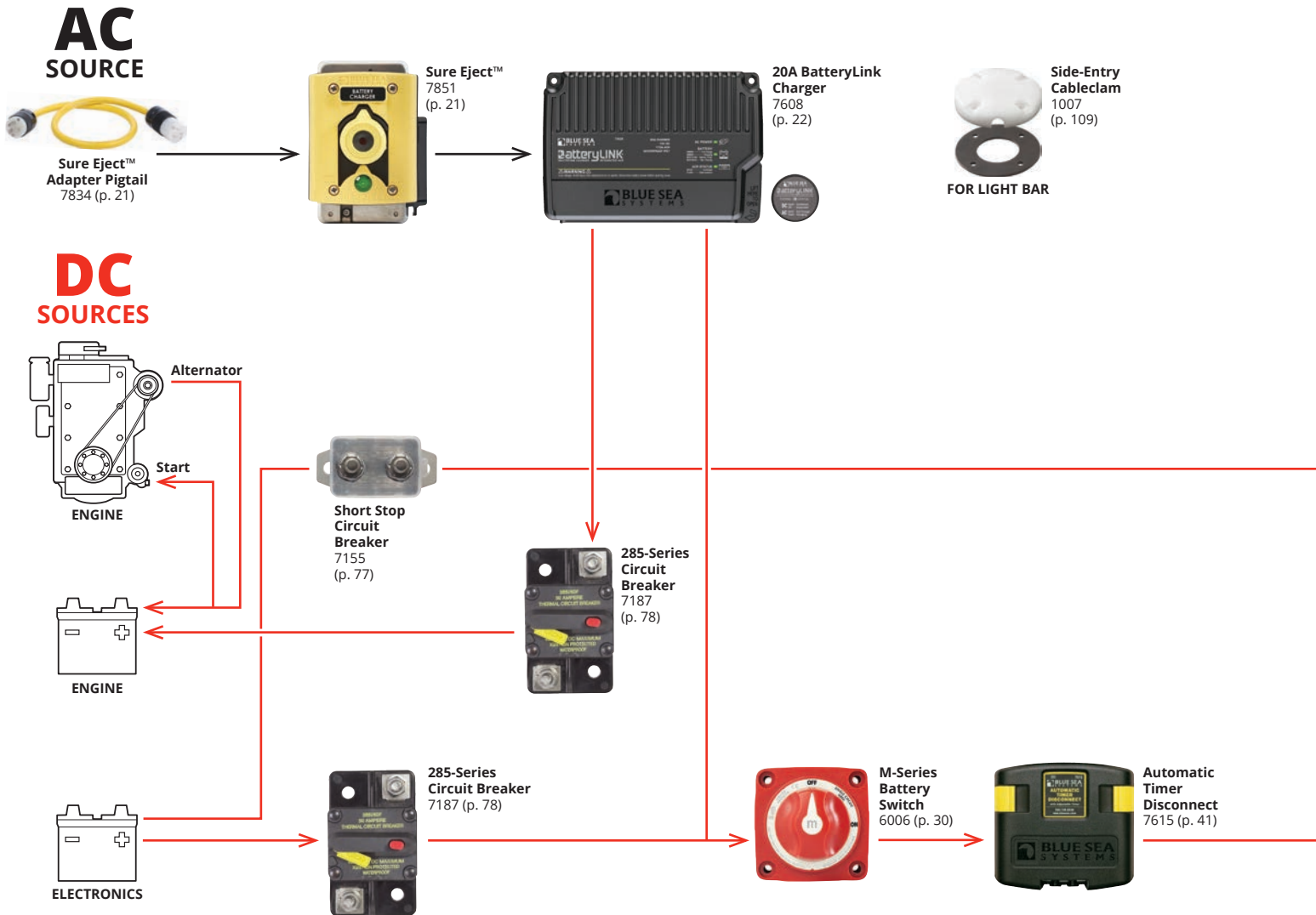

The diagram above is intended for reference only. Consult an electrical professional for system design and circuit protection.

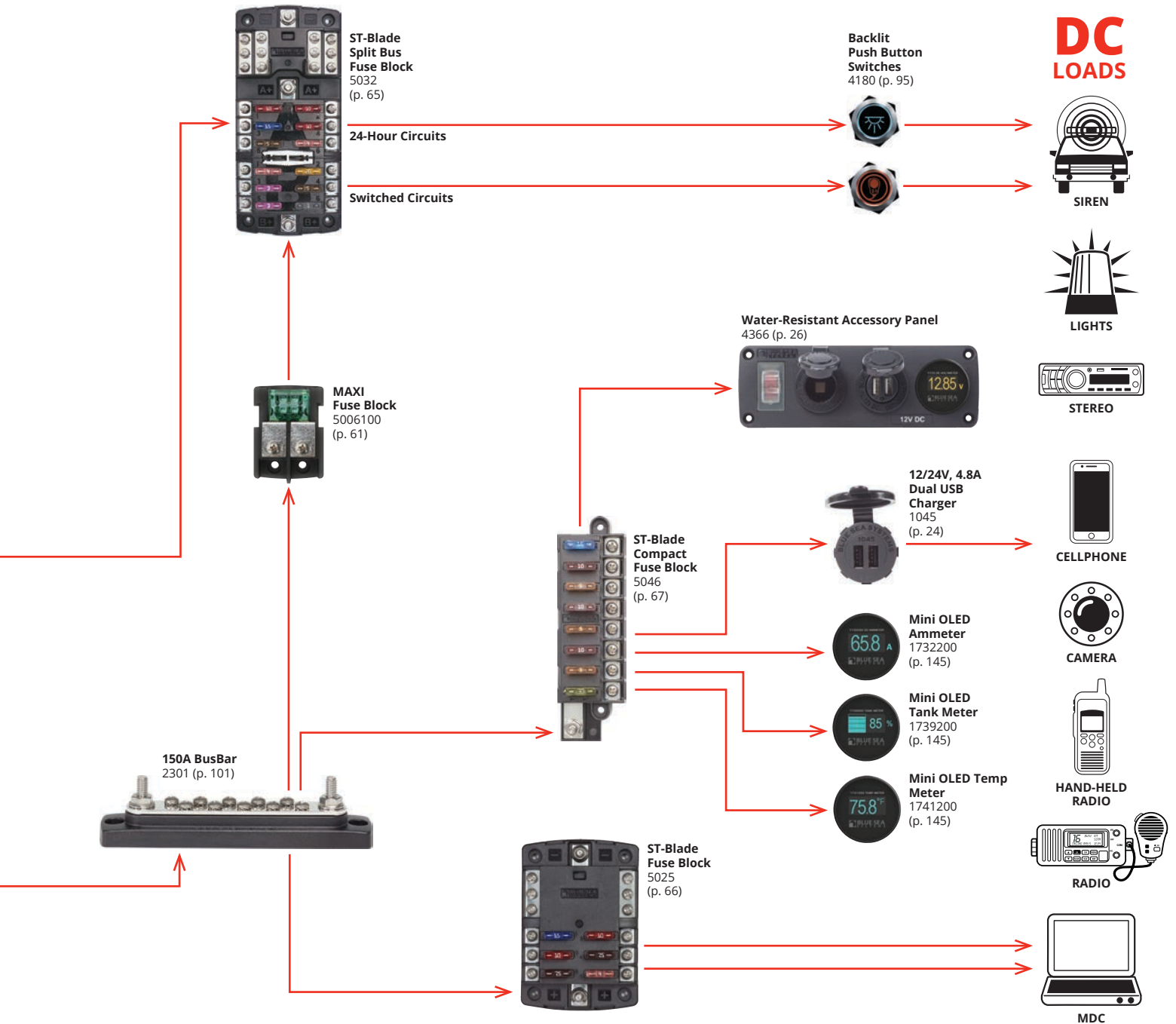
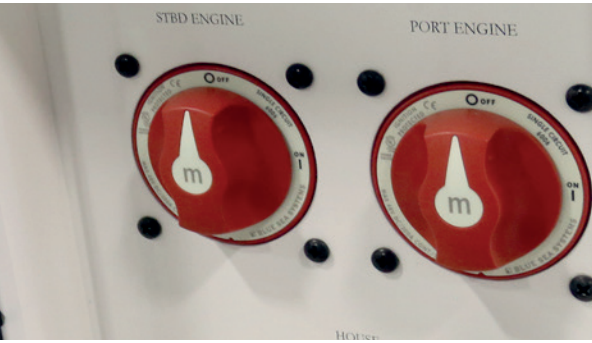

### DC LOADS





# Fire Apparatus System

2 Battery Bank, 1 Engine

AC Current → DC Current →

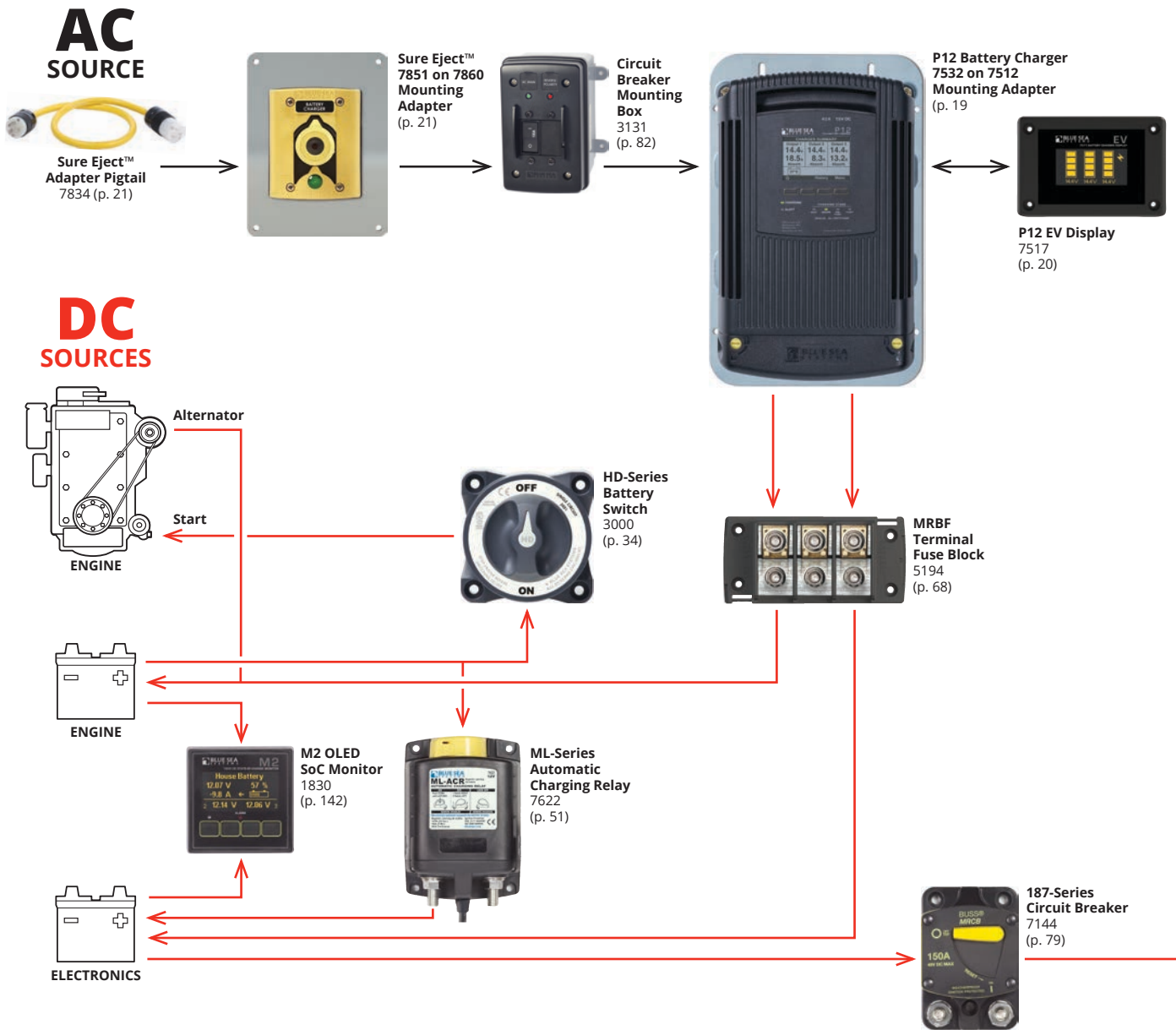

The diagram above is intended for reference only. Consult an electrical professional for system design and circuit protection.





# DC LOADS

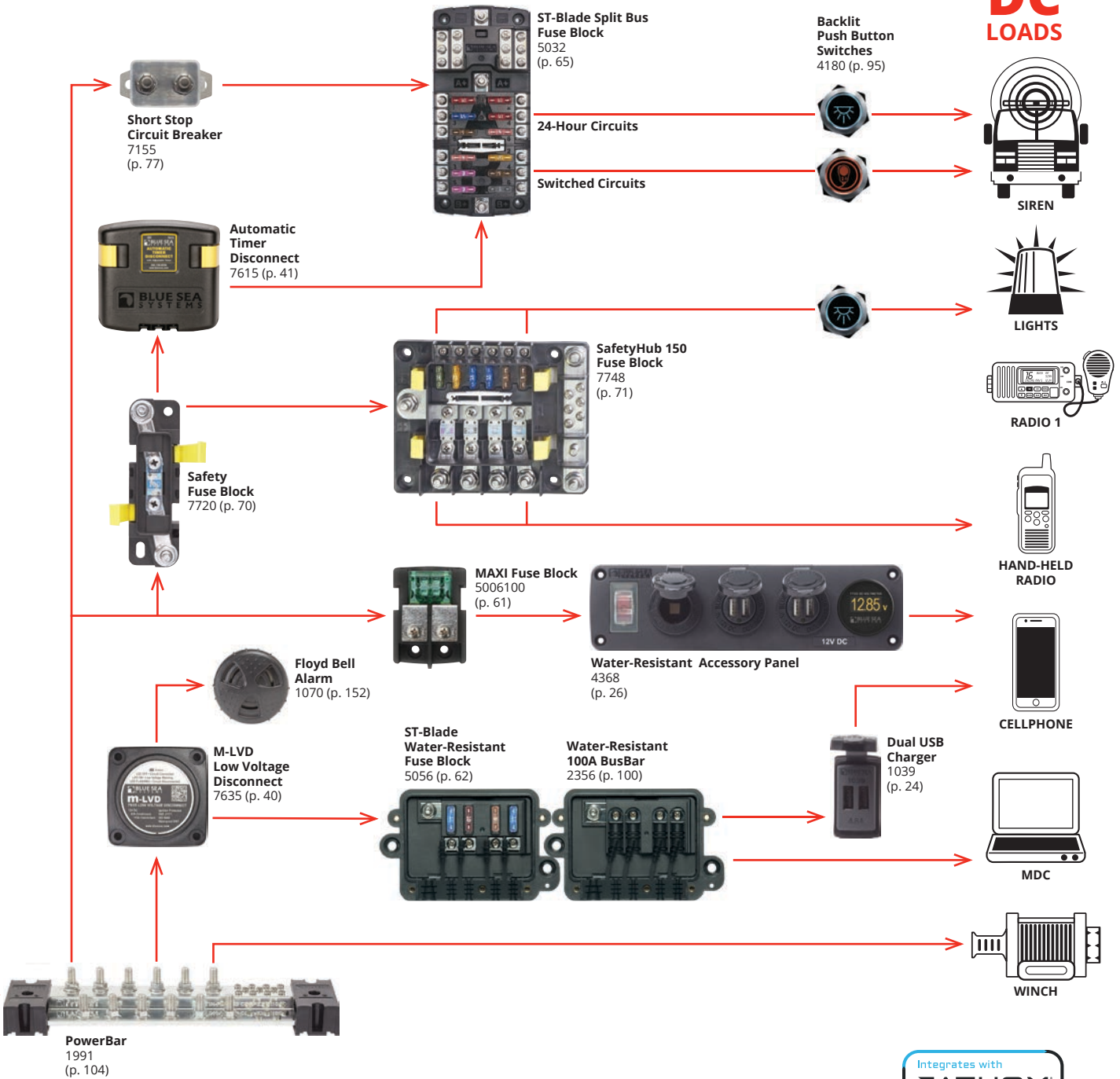

# POWER CONVERSION & CONNECTION

## Air Brake Compressors



18

Automatically maintains air brake system at ready status.

## P12 Battery Chargers



19

A four stage, three output, dry mount device designed for use in harsh environments.

## P12 Battery Charger EV Display and Remote



20

Works with the P12 Battery Chargers.

## Sure Eject™



21

Automatic AC disconnect ejects power cords upon ignition to prevent damage.

## BatteryLink® Chargers



22

Charge two batteries at or away from the dock or garage.





# POWER CONVERSION & CONNECTION

## Dual USB Chargers



24

Intelligent device recognition allows rapid charging of phones, tablets, or other mobile devices.

## 12V Socket & Plugs



25

Designed to withstand the rigors of wet environments and constant vibration.

## Water-Resistant Accessory Panels



26

Panels offer customizable 12V charging and monitoring options.

## DeckHand™ Dimmers



27

Digitally controls dimming of non-regulated LED, incandescent, and halogen lights.



## Batteries are the heart of the electrical system and are often the single largest electrical expense.

Batteries are sensitive to failure and a shortened life if not charged properly. Modern battery chemistries require adherence to manufacturers' charging recommendations. Battery manufacturers agree precise control of voltage, time, and temperature is critical. Batteries may perform poorly and fail prematurely due to a charger's failure to properly manage these functions. A well designed battery charger will allow these variables to be correctly set for the requirements of each battery type and will manage them properly in the charging process.



## Air Brake Compressors

Automatically maintains air brake system at ready status, because lives depend on it

- Designed for emergency vehicle use
- Automatically turns ON at 95 PSI and OFF at 125 PSI
- Industrial grade compressor provides reliable, long term operation
- Easy installation, no mounting plate required
- Integrated vibration damping mounts
- Serviceable air filter and water separator filter
- Works in conjunction with engine driven compressor
- Integrated auto drain to protect your air system

Nominal Voltage	12V DC
Motor Type	Permanent Magnet
Factory ON-OFF PSI Threshold	ON: 95 PSI, OFF: 125 PSI
Maximum Amp Draw	11A
Operating Temperature Range	4.4°C to 65°C (40°F to 150°F)
Air Outlet	Female 1/4" NPT

Part #	Description
7920	Horizontal Mount Air Brake Compressor
7921	Vertical Mount Air Brake Compressor
7910	Air Filter Assembly - complete
7911	Replacement Air Filter Elements
7912	Replacement Water Separator Filter

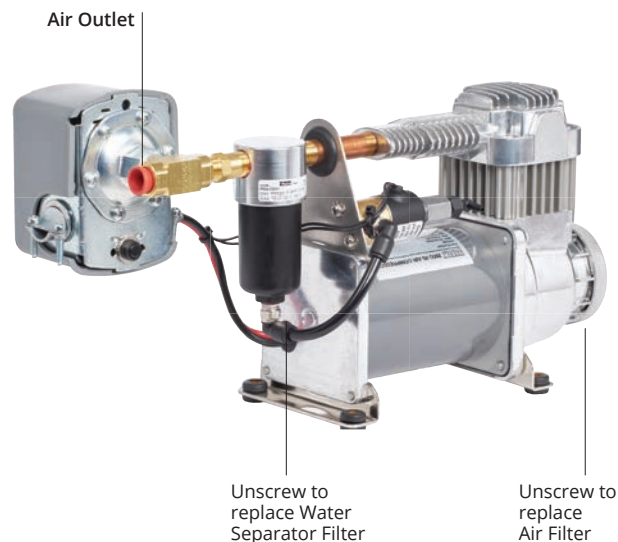
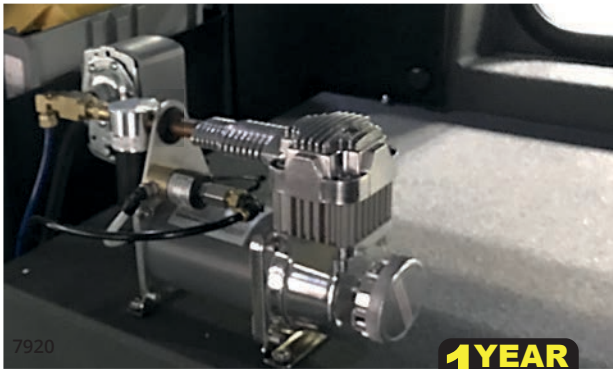

## TECH TIP

### P12 Four Stage Battery Charging

1. Bulk charges batteries to 75-80% of full charge.
2. Absorption slowly completes remaining charge.
3. PreFloat™ moves each battery individually from Absorption to PreFloat, based on the need of each battery. This prevents overcharging and damage to the batteries. Up to 0.5V difference between Absorption and PreFloat voltages can be achieved.
4. Float maintains battery charge.

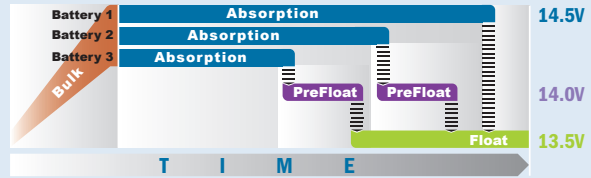

Example of Flooded Lead Acid Battery

**Battery Equalization Mode:** User selected battery equalizing provides advanced battery conditioning, revitalizing wet acid batteries.

### OTHER BATTERY CHARGERS

Conventional battery chargers move all batteries from Absorption to the Float stage simultaneously with no ability to adjust for individual battery requirements.



Example of Flooded Lead Acid Battery

**Forced Absorption:** A period when batteries are potentially over charged.

### Charge Coordination

A boat's batteries typically spend less than 2% of their time being charged by the alternator. For the remaining 98% of the time they are being maintained by the AC battery charger. During this time, it is important that the proper charging stage of Bulk, Absorption, PreFloat, or Float be applied to each battery.

#### UNDERWAY

When engine is running and alternator is charging batteries, ACRs combine batteries, providing charge to each battery from the engine.

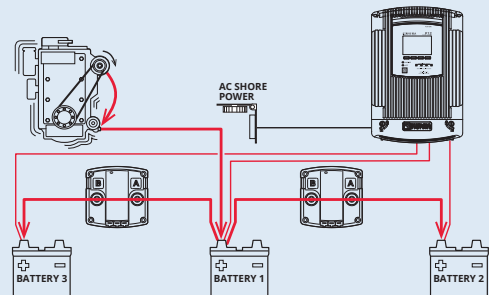

#### AT THE DOCK

When P12 Battery Charger is operating, communication with ACRs isolates batteries so the proper charge is applied to each battery.

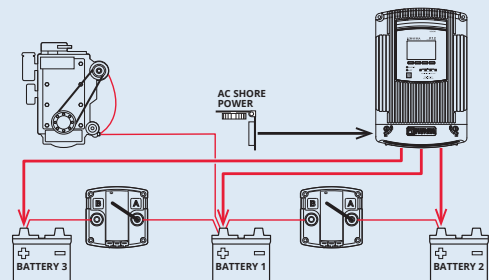

## P12 Battery Chargers

Four stage, three output, dry mount design.  
Rugged, finned aluminum case

- PreFloat™ stage prevents over charging of start battery
- Power factor corrected for efficient use of AC
- Intuitive diagnostic screens
- User defined charge profiles and customizable settings
- Provides charging for up to three battery banks
- Large, bright display
- Multi-language: English, French, German, Italian, Spanish
- Charge Coordination with Blue Sea Systems Automatic Charging Relays (ACR) controls ACR state ensuring proper float stage for each battery
- Battery Temperature Compensation - adjusts charge voltage based on battery temperature
- AC over and under voltage shut down and automatic restart
- Over and under battery temperature protection - charger will not operate if battery temperature rises above or falls below a set value
- DC over voltage and reverse polarity protection
- Surge and short circuit protection



7532

Part #	7531	7532
Total Output Current	25A	40A
Input AC Current	4.5A @ 115V AC 2.25A @ 230V AC	7.5A @ 115V AC 3.75A @ 230V AC
Recommended Battery Bank Sizes*	60Ah Minimum Example: 1 × Group 24 330Ah Maximum Example: 3 × Group 31	60Ah Minimum Example: 1 × Group 24 440Ah Maximum Example: 4 × Group 31
Nominal Output Voltage	12V DC	
Output Connections	3 positive, 1 negative	
Universal AC Input Voltage	90V-265V AC	
Input Frequency Range	45-65 Hz	
Typical Float Voltage	13.5V DC	
Max. Available Voltage	16.0V DC	
Output Voltage Accuracy	0.05V DC	
Operating Temperature	-20°C (-4°F) to 70°C (158°F)	
Storage Temperature	-30°C (-22°F) to 80°C (176°F)	
Battery Types**	Flooded, Gel, AGM, TPPL, User	
Width in (mm)	8.46 (215)	
Height in (mm)	13.00 (330.6)	
Depth in (mm)	4.30 (109)	
Regulatory	CE marked, Designed and constructed for compliance to UL-1236 Marine, CSA 22.2 No. 107.2, and ABYC A-31 standards. Ignition protection per ISO 8846, and SAE J1171. Meets FCC Part 15, Class B requirements. Designed and tested to comply with California Energy Commission (CEC) efficiency requirements, and ship with these settings by default.	

\* Battery bank sizes are tested to California Energy Commission compliance (CEC). Larger and smaller size banks could charge well, but consume slightly more power over the charging cycle.  
\*\* Consult battery manufacturer specifications for other battery types to avoid damage. Do not mix battery types.



## Battery Charger Mounting Adapter

Easily mount any Blue Sea Systems P12 Battery Charger or ProMariner ProNauticP Battery Charger without drilling new holes

- Mounts directly into industry standard mounting holes from existing chargers
- Integrated nuts allow battery charger mounting fasteners to be inserted from either the front or rear
- Fasteners included with the Mounting Adapter:  
Qty 4: #10-32 x 0.75" pan head machine screws  
Qty 4: #10-32 Nylock Nuts



Part #	Description
7512	Battery Charger Mounting Adapter

### Related Products



P12 Displays page 20

SI-ACR page 47

ML-Series ACRs page 51

MRBF Fuse Blocks page 68

## EV Battery Charger Display

Intuitive battery monitoring for emergency vehicle use



P12 Charger Summary Screen



- Designed for emergency vehicle use
- Drop in replacement for traditional rectangular displays
- Automatically detects 1-3 battery banks
- AC charge indication verifies that power is connected and the battery charger is charging
- Plain language fault indication relays if there is a fault with the battery charger
- Dip switch selectable screen configuration allows the display to show voltage bar graphs or the P12 Battery Charger summary screen
- Displays voltage bar graphs even when AC power is not present
- Optional standby mode shuts off screen after 4 hours of inactivity
- Automatic ON based on motion with integrated knock sensor
- Bright, daylight readable, OLED display

Part #	7517
Display Size inchs (mm)	2.1 x 1.1 (55 x 28)
Display Type	Yellow OLED
Input Voltage	6V-36V DC, reverse polarity protected
Amperage Draw	50 mA - Maximum < 1 mA in Standby Mode - Minimum
Standby Mode	Shuts off screen after 4 hours of inactivity. Will resume normal function upon movement of the vehicle or by tapping the unit several times in succession.
Accuracy	± 1% at 36V DC
Number of Inputs	3 battery inputs with common reference
Width in (mm)	4.7 (119.25)
Height in (mm)	3.2 (80.5)
Depth in (mm)	1.2 (29.7)
Regulatory	Monitor face is IP66 - protected against powerful water jets when installed according to instructions.

## P12 Battery Charger LED Remote

Indicates battery charger stage and alerts as well as controlling basic battery charger functions



7520



1521

### LED Indicators

- Quick check for green light confirms charging
- Displays charging stage including PreFloat for each battery
- Indicates when the charger is in equalization mode
- Indicates charger's internal fan mode
- Displays the percentage of output current for each battery. Will also indicate maximum output setting when maximum output is adjusted to accommodate for AC source limitations.
- Provides warning and alert status for quick diagnostics

### Four Control Buttons

- **Fan:** User adjustable settings (OFF, LOW, or HIGH)
- **Dim/ Alarm:** Provides adjustment to brightness of LEDs on display as well as Silence function for alarms.
- **Output:** User adjustable charger output when AC source limitations exist that require lowering the AC current draw.
- **Standby:** Places P12 Battery Charger into standby mode

Part #	7520	1521
Remote	LED Remote	360 Panel
Width in (mm)	4.15 (105.46)	4.88 (123.83)
Height in (mm)	3.01 (76.56)	4.75 (120.65)
Depth in (mm)	.95 (23.91)	.95 (23.91)

### Related Product



P12 Battery Charger  
page 19





## Sure Eject™

Automatic AC disconnect ejects power cords upon ignition to prevent damage

- Designed for emergency vehicle use
- Motor driven design ensures years of reliable operation
- The ejection piston is self-recessing, with no cocking required
- Keyed plug design allows for easy one-handed insertion of connector
- Anti-arcing design on insertion and ejection
- Built in status LED indicates the presence of AC power and ejection alerts
- Automatically attempts additional ejections if needed
- Compatible with existing 15A and 20A connectors already in the station
- Standard mounting holes for easy retrofit
- Includes connector, yellow cover, and 5 label kit
- 6 color covers available
- Pigtails offer a secondary method of disconnecting from shore power for added reliability (sold separately)

Operating Voltage Range	8V -16V DC
Nominal Voltage	120V AC
Continuous Rating	7850: 15A, 7851: 20A

Part #	Description
7850	15A Sure Eject
7850001	15A Sure Eject - No Cover
7851	20A Sure Eject
7851001	20A Sure Eject - No Cover
7840	15A Connector
7841	20A Connector
7820	Yellow Cover
7821	Red Cover
7822	Black Cover
7823	White Cover
7824	Blue Cover
7825	Grey Cover
7830	15A Sure Eject Yellow Pigtail
7831	20A Sure Eject Yellow Pigtail
7832	15A Standard Black Pigtail
7833	20A Standard Black Pigtail
7834	15A to 20A Adapter Pigtail



7830 / 7831



7840 / 7841



7832 / 7833



7834

### Related Products



P12 Battery Charger  
page 19



EV Battery Charger Display  
page 20



7850 / 7851



7851001

7850001

## Sure Eject Mounting Adapter

Easily install 15A and 20A Sure Eject units from the outside of a vehicle

- Allows one person installation of Sure Eject
- No special shaped cutouts required
- Threaded backing plate secures Sure Eject to vehicle without added hardware
- Compatible with all 15A and 20A Sure Eject ejection units and covers



Part #	Description
7860	Sure Eject Mounting Adapter

# 10A & 20A BatteryLink® Chargers

Charge two battery banks with shore power or the engine's alternator

- AC charging at the dock or garage: Use AC shore power to charge two isolated battery banks with the 3 stage battery charger
- DC charging away from the dock or garage: Share the DC power from the alternator with both the start and the auxiliary battery through the integrated ACR
- 20A models only: Emergency jump start by combining batteries if start battery is low. - single pole/single throw switch required. (sold separately)
- Battery temperature compensation prolongs battery life (1820 included)
- Start isolation protects sensitive electronics from voltage sags and spikes
- Includes LED remote indicator for charge status at the helm
- Snap-on insulating cover



**10A Battery Charger - 65A ACR**  
 7603 International: Bare wire  
 7604 European: CEE 7/7  
 7605 North American: NEMA 5-15P



Nominal Output Voltage	12V DC
Output Connections	2 positive, 1 negative
Universal AC Input	100V-240V AC, 50/60 Hz
Typical Float Voltage (25°C)	13.5V DC
Typical Absorption Voltage (25°C)	14.4V DC
ACR Combine Voltage	13.0V
ACR Open Voltage	12.75V
Terminal Stud Size	1/4"-20 (accepts M6 ring terminal)
Maximum 1/4" Terminal Stud Torque	60 in-lb (6.8 Nm)
Positive Terminal Stud Size (20A model only)	3/8"-16 (accepts M10 ring terminal)
Maximum 3/8" Terminal Stud Torque	140 in-lb (15.8 Nm)
Quick Connect Terminal Size	1/4" x 0.032"
Battery Types	Flooded, AGM, TPPL

**IGNITION PROTECTED**

**North American Models**

Part #	Total Output Current	ACR Continuous	Plug Style
7605	10A	65A	North American: NEMA 5-15P
7608	20A	170A	North American: NEMA 5-15P

**Regulatory**

Designed and constructed for compliance to UL-1236 Marine, CSA 22.2 No. 107.2 and ABYC A-31 standards. Ignition protected per ISO 8846 and SAE J1171. Meets FCC Part 15, Class B requirements. Designed and tested to comply with California Energy Commission (CEC) efficiency standards. Waterproof IP67 - protected against immersion up to 1 meter for 30 minutes (see inside back cover)

**International Models**

Part #	Total Output Current	ACR Continuous	Plug Style
7607	20A	170A	European: CEE 7/7
7606	20A	170A	International: Bare wire

**Regulatory**

CE Certified, Designed and constructed for compliance to EN60335-2-29. Ignition protected per ISO 8846 and SAE J1171. Waterproof IP67 - protected against immersion up to 1 meter for 30 minutes (see inside back cover)

**Related Products**



M-Series Battery Switch page 30

e-Series Battery Switch page 32

Mini Add-A-Battery Plus page 49

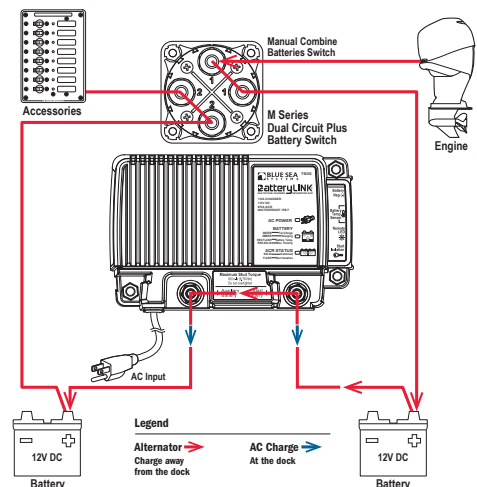

**Legend**  
 Alternator Charge away from the dock  
 AC Charge At the dock



**20A Battery Charger - 170A ACR**

- 7606 International: Bare wire
- 7607 European: CEE 7/7
- 7608 North American: NEMA 5-15P
- 7609 Australia/New Zealand: AS/NZS 3112

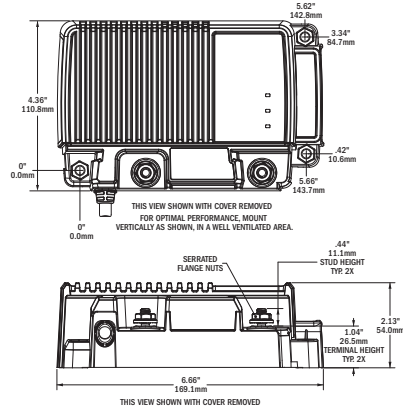

**10A BatteryLink Chargers**

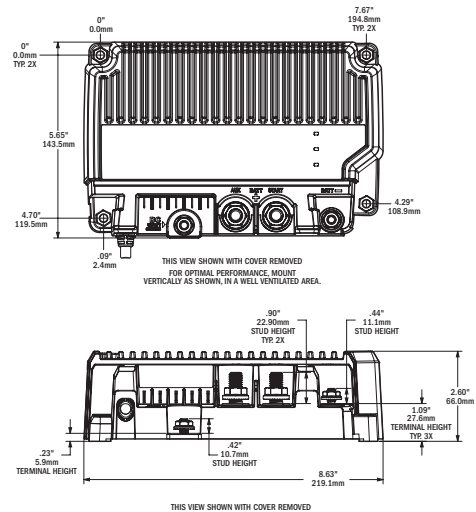

**20A BatteryLink Chargers**

**TECH TIP**

**AC & DC Battery Charging Explained**

**DC Charging (Away from the Dock or Garage)**

The BatteryLink Charger incorporates DC charging through an integrated Automatic Charging Relay (ACR). An ACR uses a relay combined with a voltage sensing circuit. When a DC charge is applied to the start battery, and causes the voltage to rise above 13.0V, the relay closes and combines the two batteries to share the charge. When the charge is taken away or a load on the battery causes the voltage to drop below 12.75V, the relay will open, isolating the two batteries. This means that even when the BatteryLink Charger is disconnected from AC power you can charge both your battery banks with a DC charging source, like an engine alternator.

**AC Charging (At the Dock or Garage)**

The BatteryLink Charger is powered by AC when the cord is plugged in, and will source current to charge your batteries. However, unlike a typical two bank charger, the BatteryLink Charger will charge both batteries simultaneously using the integrated ACR. This works in the same way as when an external DC charging source is used. When AC power is applied, and the voltage of the start battery rises above 13.0V, the ACR will close. This combines the batteries, allowing charge current to flow to the auxiliary battery as well as the start battery. For this reason, the BatteryLink Charger can only be used in 12V applications.

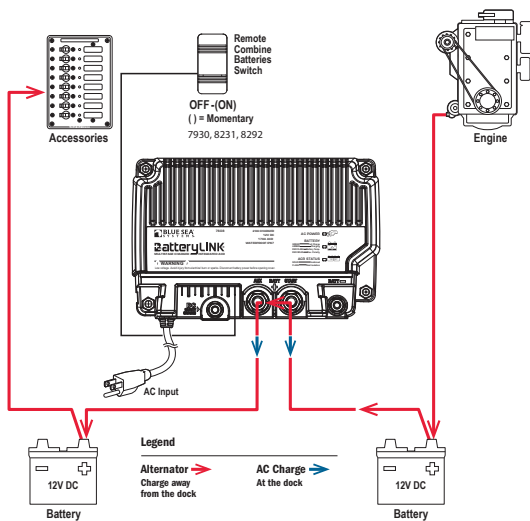



## 12/24V Dual USB 2.1A Chargers

Charge two mobile devices on the go



- Compatible with popular mobile devices
- Internal fusing
- Conformal coated circuit board for the harsh marine environment
- Protective dust cap keeps debris and moisture out
- Mounts in a common 1-1/8" hole

Maximum Output Current	2.1A DC (total)
Input Voltage Range	9V-32V DC
Output Voltage	5V DC ±5%
Port Configuration	D +=2.0V, D-=2.8V
Parasitic Current Draw	15mA
Thermal Overload Protection	Yes
Short Circuit Protection	Yes
Reverse Polarity Protection	Yes
USB	2.0, Type A
Cutout Dimensions	1-1/8" (29 mm) diameter
Regulatory	RoHS, CE certified

Part #	Description	Color
1016	Socket Mount Charger	Black
1016200	Socket Mount Charger	White

### Related Products



Water-Resistant USB Accessory Panels page 26

## USB Extension

Control a stereo or other device remotely from a phone or tablet in the cockpit

- USB 2.0 data/voltage port easily mounts at the dash with a prewired connecting cable that conveniently plugs directly into the USB on the stereo.
- Protective dust cap with tether keeps out dust and spray



Part #	1044
Voltage	12V DC
Cable Length	5 ft (1.524M)
Cutout Dimensions	1-1/8" (29 mm) diameter
USB	2.0, Type A
Regulatory	IP66 - protected against powerful water jets (see inside back cover)

## 12/24V Dual USB 4.8A Chargers

Intelligent device recognition maximizes charge rate for phones, tablets, or other mobile devices



- Charges at the speed required by specific devices
- Internal filtering for reduced electronic interference
- Over temperature protection
- Conformal coated circuit board for the harsh marine environment
- Protective dust cap keeps debris and moisture out
- 1039 Mounts in an existing contura switch aperture
- 1045 Mounts in a common 1-1/8" hole

Maximum Output Current	4.8A DC (total)
Input Voltage Range	9V-32V DC
Output Voltage	5V DC ±5%
Port Configuration	Intelligent Device Recognition
Parasitic Current Draw	1mA
Thermal Overload Protection	Yes
Short Circuit Protection	Yes
Reverse Polarity Protection	Yes
USB	2.0, Type A
Cutout Dimensions	1039 - 1.45" × 0.83" (36.83 × 21.08 mm) 1045 - 1-1/8" (29 mm) diameter
Regulatory	RoHS, CE certified

Part #	Description
1039	Switch Mount Charger
1045	Socket Mount Charger

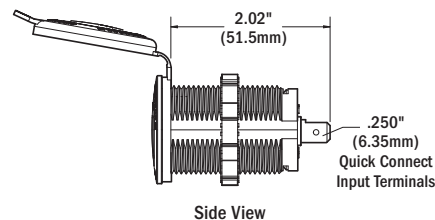
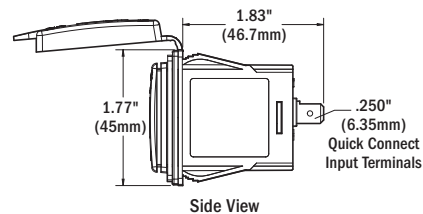

### Related Products



Water-Resistant USB Accessory Panels page 26

### 48V Dual USB 4A Chargers

Intelligent device recognition maximizes charge rate for phones, tablets, or other mobile devices



1038

1046

- Ideal for golf carts and other 48V systems
- Spring-hinged cover keeps debris and moisture out
- Charges at the speed required by specific devices
- Internal filtering for reduced electronic interference
- Over temperature protection
- Conformal coated circuit board for the harsh marine environment
- 1038 Mounts in an existing contura switch aperture
- 1046 Mounts in a common 1-1/8" hole

Maximum Output Current	4A DC (total)
Input Voltage Range	32V-64V DC
Output Voltage	5V DC ±5%
Port Configuration	Intelligent Device Recognition
Parasitic Current Draw	1mA
Thermal Overload Protection	Yes
Short Circuit Protection	Yes
Reverse Polarity Protection	Yes
USB	2.0, Type A
Cutout Dimensions	1038 - 1.45" × 0.83" (36.83 × 21.08 mm) 1046 - 1-1/8" (29 mm) diameter
Regulatory	RoHS

Part #	Description
1038	Switch Mount Charger
1046	Socket Mount Charger
1035	Spring-hinged cover for 1038 & 1039
1036	Spring-hinged cover for 1046 & 1045

### 360 Panels

Integrates DC Socket and Dual USB Chargers with 360 Panel System



1472

1478

Part #	Description	Width in (mm)	Height in (mm)	Depth in (mm)
1472	2 × 1011	4.88 (123.83)	4.75 (120.65)	1.50 (38.10)
1478	1 × 1011, 1 × 1016	4.88 (123.83)	4.75 (120.65)	1.50 (38.10)

### 12V Socket and Plugs

Designed to withstand the rigors of wet environments and constant vibration

- Corrosion resistant materials
- Twist lock system - plug locks securely into socket
- Internal strain relief and cord seal
- current carrying components are nickel plated copper alloy
- Plug has a sealing ring to keep out spray and make it seat firmly in the socket
- Socket features a protective dust cap that keeps debris and moisture out
- 1012 and 1013 heavy duty 18 gauge wire
- 1012 cord reaches up to 6 feet

Voltage Nominal	12V DC
Amperage Max. Operating	15A DC (socket)
Amperage Max. Operating	10A DC (plug)
Socket Cutout Dimensions	1-1/8" (29 mm) diameter

Part #	Description	Dust Cap
1010	Plug	--
1011	Black Socket	Yes
1011200	White Socket	Yes
1012	Single Plug with Single Socket Extension	Yes
1014	Mounting Bracket for Sockets	--
1015	Plug and Socket Set - Includes 1010 and 1011	Yes



1011



1011200



1010

1012

1014

## Water-Resistant Accessory Panels

Easy to install panels offer customizable 12V charging and monitoring options

- Pre-wired harness included in all panels for easy installation
- Silicon breaker boots and gasket protects against water ingress
- Illuminated Carling Technologies 15A circuit breaker allows the ability to shut off panel preventing parasitic draw
- Polycarbonate/ABS panel face is UV-stabilized, flame retardant, and will not corrode
- 12V DC only

Part #	Description	Width in (mm)	Height in (mm)	Depth in (mm)
4363	15A Circuit Breaker, 12V Socket, 2.1A Dual USB Charger	4.94 (125.4mm)	2.25 (57.2mm)	2.53 (64.3mm)
4364	15A Circuit Breaker, 2x Blank Apertures	4.94 (125.4mm)	2.25 (57.2mm)	Based on components
4365	15A Circuit Breaker, 12V Socket, 2x 2.1A Dual USB Chargers	6.61 (168.0mm)	2.25 (57.2mm)	2.53 (64.3mm)
4366	15A Circuit Breaker, 12V Socket, 2.1A Dual USB Charger, Mini Voltmeter	6.61 (168.0mm)	2.25 (57.2mm)	2.75 (69.8mm)
4367	15A Circuit Breaker, 3x Blank Apertures	6.61 (168.0mm)	2.25 (57.2mm)	Based on components
4368	15A Circuit Breaker, 12V Socket, 2x 2.1A Dual USB Chargers, Mini Voltmeter	8.29 (210.5mm)	2.25 (57.2mm)	2.75 (69.8mm)
4369	15A Circuit Breaker, 4x Blank Apertures	8.29 (210.5mm)	2.25 (57.2mm)	Based on components

**Regulatory** 4367, 4364, 4369 Only - CE certified  
IP45 - protected against water jets (see inside back cover)



4367



4364



4365



4363



4366



4368

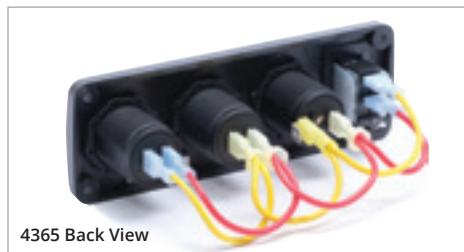

4365 Back View



4369

### Related Products



2.1A Dual USB  
Chargers  
page 24



4.8A Dual USB  
Chargers  
page 24



12V Socket  
page 25



Mini LED Meters  
page 145



## DeckHand™ Dimmers

Digitally controls dimming of non-regulated LED, incandescent, and halogen lights

- Illuminated exit with adjustable time delay
- Supports multiple switch locations
- Memory for last dimmer setting
- Bulb saver prevents bulb aging while batteries are being charged
- Provides continuous voltage control from 0 to 100% of input voltage
- Offset mounting tabs allow dimmers to be mounted close together
- Retail package includes momentary SPDT (ON)-OFF-(ON) switch 8216 (page 92)

Maximum Parasitic Current	<2mA
Temperature Rating	-40°C to 85°C
Regulatory	CE marked, Meets ISO 8846 and SAE J1171 external ignition protection requirements

**IGNITION PROTECTED**

Part #	Amps	Volts	Operating Range	Width in (mm)	Height in (mm)	Depth in (mm)
7506	6A	12V DC	9V-16V	3.23 (82.0)	3.47 (88.1)	1.30 (33.0)
7504	6A	24V DC	18V-32V	3.23 (82.0)	3.47 (88.1)	1.30 (33.0)
7507	12A	12V DC	9V-16V	3.23 (82.0)	3.47 (88.1)	1.30 (33.0)
7509	12A	24V DC	18V-32V	3.23 (82.0)	3.47 (88.1)	1.30 (33.0)
7508	25A	12V DC	9V-16V	3.23 (82.0)	3.47 (88.1)	1.30 (33.0)

Note: Do not use with regulated LED bulbs.



7508

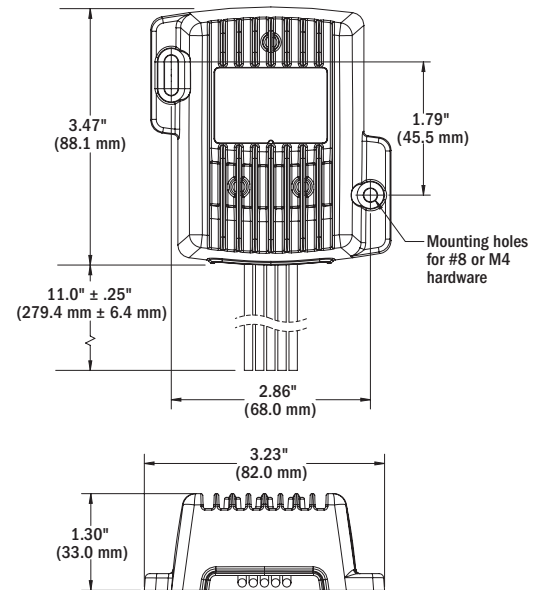

## TECH TIP

### Illuminated Exit

The illuminated exit feature allows boaters to safely disembark before the lights automatically turn off. Using the illuminated exit feature:

**One minute delay:** Hold the switch in up position for 2 seconds, lights will flash. Release switch after first flash and the lights will remain on for 1 minute.

**Two to five minute delay:** Hold the switch in up position for 1-4 seconds after the first flash. Release the switch after 2 to 5 flashes. The lights will remain on for 1 minute for each flash up to a maximum of 5 minutes.

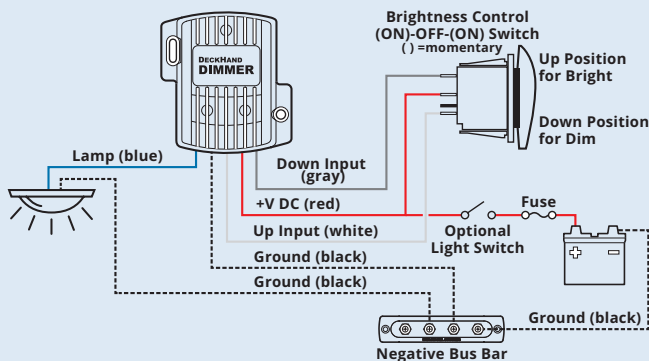

Example of nested DeckHand Dimmers

# BATTERY MANAGEMENT

## Manual Battery Switches



30

Commonly used on small boats or vehicles where the batteries are located near the operator.

## Battery Management Panels



38

Easily manages multiple battery bank systems.

## Solenoid Switches



39

Electronic switches with no manual control, for circuits where a manual battery disconnect is offered elsewhere in the circuit.

## Low Voltage Disconnect (LVD)



40

Senses low battery voltage and disconnects non-critical loads to save power for engine starting.



# BATTERY MANAGEMENT

## Automatic Timer Disconnect (ATD)



41

Adjustable time or voltage based battery disconnect automatically shuts off devices to preserve battery power.

## Remote Battery Switches (RBS)



42

Used when there is not an easily accessible location near the batteries to mount a battery switch, requiring either a long cable run or a battery switch mounted in a difficult to access location.

## Automatic Charging Relays (ACR)



47

Automatically combines two battery banks during charging and isolates batteries when discharging. Optionally isolates batteries when starting the engine.

## Add-A-Battery Kits



49

Simplify switching and automate charging for two battery bank systems. Simply turn the battery switch On when you arrive and Off when you leave.



**Battery management is central to the safe operation of a boat or vehicle.**

All boats and vehicles with an engine have at least one battery with the primary purpose of starting the engine and providing power for loads such as lights, pumps, and electronics. The safe switching between batteries, loads, and charge sources is achieved using products in this section.



## M-Series Battery Switches

300A continuous rating for outboards and small gasoline or diesel engines

- Tin-plated copper studs for maximum conductivity and corrosion resistance
- Studs accept 3/8" (M10) ring terminals
- 7/8" (22 mm) stud length accepts multiple cable terminals
- Blue Sea Systems one-piece terminal stud design never loosens over time
- One-piece stainless flange nuts ensure safe and secure connections
- Isolating cover protects rear contacts
- Breakout tabs allow wire access in any direction
- 6 Circuit label set included (not included with 6004, 6005, 6004200, 6005200)
- Icon Circuit Identification Label Kit available 7902 - sold separately (p. 158)

Part #	6004, 6005, 6006, 6004200, 6005200, 6006200	6007, 6007200, 6008, 6008200	6010, 6011, 6010200, 6011200
Cranking Rating: 30 sec.	900A	900A	675A per circuit
Intermittent Rating: 5 min.	500A	500A	450A per circuit
Continuous Rating	300A	300A	300A per circuit
Voltage Max. Operating	48V DC	32V DC	32V DC
Regulatory	CE marked, ISO 8846, UL Listed - UL 1107 electric power switches, Meets American Boat and Yacht Council (ABYC) requirements, Meets UL 1500 and SAE J1171 external ignition protection requirements, IP66 - protected against powerful water jets (see inside back cover)		

**IGNITION PROTECTED**

Part #	Description	Color
6004	Single Circuit ON-OFF with Locking Key	Red
6004200	Single Circuit ON-OFF with Locking Key	Black
6005	Single Circuit ON-OFF with Key	Red
6005200	Single Circuit ON-OFF with Key	Black
6006	Single Circuit ON-OFF	Red
6006200	Single Circuit ON-OFF	Black
6007	Selector 4 Position	Red
6007200	Selector 4 Position	Black
6008	Selector 3 Position	Red
6008200	Selector 3 Position	Black
6010	Dual Circuit™	Red
6010200	Dual Circuit™	Black
6011	Dual Circuit Plus™	Red
6011200	Dual Circuit Plus™	Black
7903	Removable key for 6004	Red
7903200	Removable key for 6004200	Black
7900	Removable key for 6005	Red
7900200	Removable key for 6005200	Black
7901	Removable knob	Red
7901200	Removable knob	Black
9159	Paralleling link bus (2 pack)	-
1139	360 Panel Battery Switch Module	-

For the full list of specifications and operation diagrams see pages 36-37

For the wiring schematics for typical applications see pages 162-163

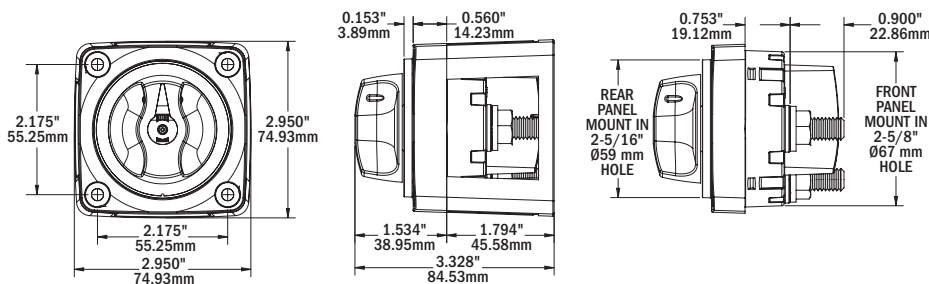

## Mounting Options



## M-Series Battery Switch Mounting Panel



1139 (switch sold separately)  
**Dimensions (W x H):**  
 4.88 × 4.75 in  
 (123.83 × 120.65 mm)

- 360 Panel System
- Accepts the M-Series Battery Switch, M-ACR, or M-LVD

**Single Circuit ON-OFF**

Switches a single battery to a single load group



6004



6004, 6005, 6006



6005



6006

**Selector 3 Position**

Switches isolated battery banks to all loads



6008

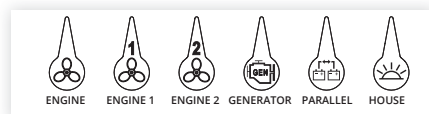

6 Circuit Label Set

**Related Products**

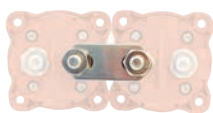

Paralleling Link Bus  
1139 see table



Add-A-Battery  
360 Panel page 38



M-LVD  
page 40



M-ACR  
page 46



Mini Add-A-Battery  
page 48



Mini Add-A-Battery Plus  
page 49

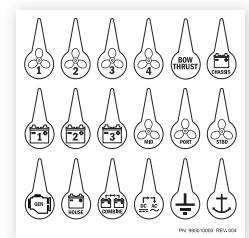

Circuit Identification Label Kit  
page 158

**Selector 4 Position**

Switches isolated battery banks to all loads or combines battery banks to all loads



6007



**Dual Circuit™**

Simultaneously switches two isolated battery banks or circuits. May be used to switch the positive and negative conductors for required applications.



6010



**⚠ WARNING**

The positive and negative conductors should not be attached to the same battery switch. The only exceptions are the Dual Circuit™ Battery Switches, 6010 and 5510. Since these models have electrically isolated circuits and do not include a combine feature, they can provide disconnect to the positive and negative conductors simultaneously.

**Dual Circuit Plus™**

Simultaneously switches two isolated battery banks or combines battery banks to all loads. CAN NOT be used to switch positive and negative conductors because of the combine feature.



6011



## e-Series Battery Switches

350A continuous rating for inboard gasoline or diesel engines

- Tin-plated copper studs for maximum conductivity and corrosion resistance
- Accepts up to 4/0 AWG (120 mm<sup>2</sup>) battery cables
- Studs accept 3/8" (M10) ring terminals
- 7/8" (22 mm) stud length accepts multiple cable terminals
- Blue Sea Systems one-piece terminal stud design never loosens over time
- One-piece stainless flange nuts ensure safe and secure connections
- Fits most standard Perko and Guest battery switch hole patterns
- Tactile indicator conveys knob position by feel
- Icon Circuit Identification Label Kit available 7902 - sold separately (p. 158)

Part #	9003E, 9004E	9001E, 9002E, 11001	5510E, 5511E
Cranking Rating: 30 sec.	1,200A	1,200A	700A per circuit
Intermittent Rating: 5 min.	600A	600A	525A per circuit
Continuous Rating	350A	350A	350A per circuit
Voltage Max. Operating	48V DC	32V DC	32V DC
Regulatory	CE marked, ISO 8846, UL Listed - UL 1107 electric power switches, Meets American Boat and Yacht Council (ABYC) requirements, Meets UL 1500 and SAE J1171 external ignition protection requirements, IP66 - protected against powerful water jets (see inside back cover)		

### IGNITION PROTECTED

Part #	Description	AFD*
5510E	Dual Circuit™	--
5511E	Dual Circuit Plus™	--
9001E	Selector 4 Position	--
9002E	Selector 4 Position	Yes
9003E	Single Circuit ON-OFF	--
9004E	Single Circuit ON-OFF	Yes
11001	Selector 3 Position	Yes

\* Alternator Field Disconnect (AFD) feature protects the diodes in the alternator in the event of the switch being switched to the OFF position while the engine is running. If the AFD is not used to protect the alternator, an LED can be connected to the AFD terminals to indicate when the battery switch is in any position but OFF.

For the full list of specifications and operation diagrams see pages 36-37  
 For the wiring schematics for typical applications see pages 162-163

## Mounting Options

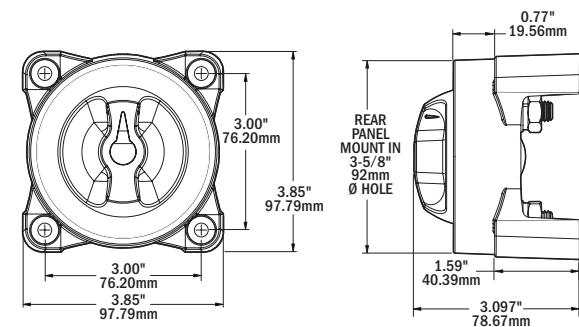
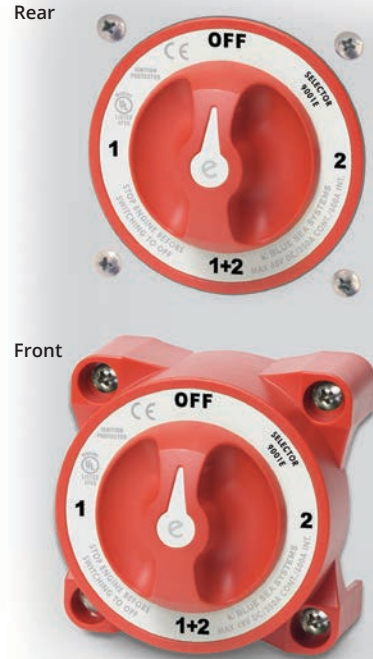

### Related Products



## TECH TIP

### Choose the Dual Circuit Plus™

- Easily manage two battery banks
- When battery bank selection is not necessary
- When using sensitive electronics
- When paired with an Automatic Charging Relay (ACR)

The Dual Circuit Plus is a double pole switch that supplies power to devices connected to a specific battery bank.

House electronics are isolated from the Start bank. This preserves the Start Battery and prevents sensitive electronics from being subjected to voltage sags and spikes during starting. Designed for use with an Automatic Charging Relay (ACR) to provide simultaneous charging of two battery banks from the engine's alternator.

### How to use the Dual Circuit Plus with an ACR:

1. Power is Needed - Turn the switch into the ON position.
2. No Power Needed (Storage) - Select OFF to prevent current draw.
3. Emergency Parallel (Jump Starting) - Turn the switch to the Combine Batteries position. Once the engine is running, turn the switch to the ON position.



**Single Circuit ON-OFF**

Switches a single battery to a single load group



9003E, 9004E\*



9003e



9004e

**Selector 3 Position**

Switches isolated battery banks to all loads



11001\*



**Selector 4 Position**

Switches isolated battery banks to all loads or combines battery banks to all loads



9001E, 9002E\*



9001e



9002e

**Dual Circuit™**

Simultaneously switches two isolated battery banks or circuits. May be used to switch the positive and negative conductors for required applications.



5510E  
PATENTED



**⚠ WARNING**

The positive and negative conductors should not be attached to the same battery switch. The only exceptions are the Dual Circuit™ Battery Switches, 6010 and 5510E. Since these models have electrically isolated circuits and do not include a combine feature, they can provide disconnect to the positive and negative conductors simultaneously.

**Dual Circuit Plus™**

Simultaneously switches two isolated battery banks or combines battery banks to all loads. CAN NOT be used to switch positive and negative conductors because of the combine feature.



5511E  
PATENTED



**TECH TIP**

**One Piece Stud**

**Blue Sea Systems ONE PIECE STUD**  
Can never loosen over time

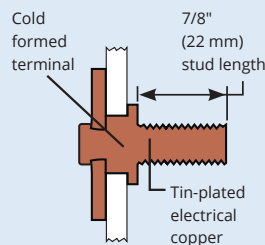

**Competitors TWO PIECE STUD**  
Can loosen and create a poor connection

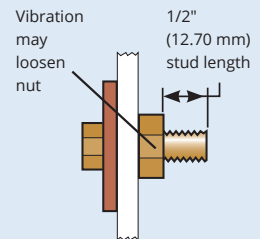

\* Includes Alternator Field Disconnect (AFD)

# HD-Series Battery Switches

Up to 600A continuous rating for large diesel engines

- Tin-plated copper studs for maximum conductivity and corrosion resistance
- Accepts up to 4/0 AWG (120 mm<sup>2</sup>) battery cables
- Studs accept 1/2" (M12) ring terminals
- 7/8" (22 mm) stud length accepts multiple cable terminals
- Blue Sea Systems one-piece terminal stud design never loosens over time
- One-piece stainless flange nuts ensure safe and secure connections
- Fits most Perko and Guest low amperage battery switch hole patterns
- Case design allows surface or rear mounting options
- Tactile indicator conveys knob position by feel
- Icon Circuit Identification Label Kit available 7902 - sold separately (p. 158)

Part #	3000, 3001	3002, 3003, 11003
Cranking Rating: 30 sec.	1,750A	1,600A
Intermittent Rating: 5 min.	900A	700A
Continuous Rating	600A	500A
Voltage Max. Operating	32V DC	32V DC
Regulatory	CE marked, ISO 8846, UL Listed - UL 1107 electric power switches, Meets American Boat and Yacht Council (ABYC) requirements, Meets UL 1500 and SAE J1171 external ignition protection requirements IP66 - protected against powerful water jets (see inside back cover)	

**IGNITION PROTECTED**

Part #	Description	AFD*
3000	Single Circuit ON-OFF	--
3001	Single Circuit ON-OFF	Yes
3002	Selector 4 Position	--
3003	Selector 4 Position	Yes
11003	Selector 3 Position	Yes

\* Alternator Field Disconnect (AFD) feature protects the diodes in the alternator in the event of the switch being switched to the OFF position while the engine is running. If the AFD is not used to protect the alternator, an LED can be connected to the AFD terminals to indicate when the battery switch is in any position but OFF.

For the full list of specifications and operation diagrams see pages 36-37  
 For the wiring schematics for typical applications see pages 162-163

## Mounting Options

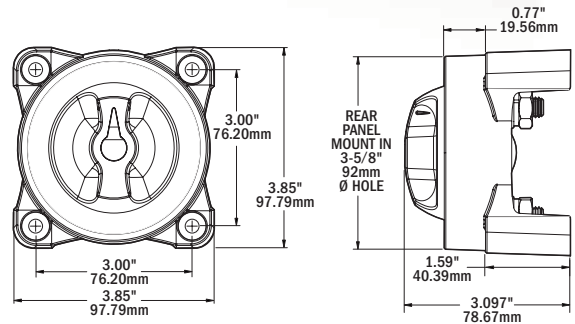

### Related Product



Circuit Identification Label Kit page 158





### Single Circuit ON-OFF

Switches a single battery to a single load group



3000, 3001\*



3000



3001

### Selector 4 Position

Switches isolated battery banks to all loads or combines battery banks to all loads



3002, 3003\*



3002



3003

### Selector 3 Position

Switches isolated battery banks to all loads



11003\*



11003

## TECH TIP

### HD-Series Connections

3000 and 3001 HD-Series ON-OFF battery switches have three studs; one stud for the battery connections and two studs for the common load terminations.

3002 and 3003 HD-Series Selector battery switches also have three studs; but the configuration is different with one stud for Battery 1, one stud for Battery 2, and one stud for the common load terminations.

#### 3000 and 3001 Connections

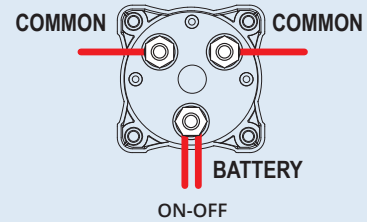

#### 3002, 3003, and 11003 Connections

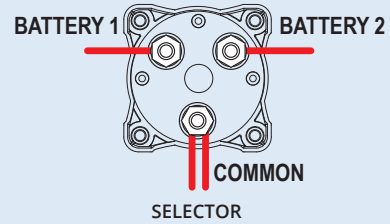

SeaForce IX builds custom sport fishing and cruising yachts which rely on Blue Sea Systems HD Heavy Duty Battery Switches for battery management in the engine room.

\* Includes Alternator Field Disconnect (AFD)



# Manual Battery Switch Specification Table



Part #	6004	6005	6006	9003E, 9004E	3000, 3001	6008	11001	11003
Page #	30			32	34	30	32	34
Switch Type	Single Circuit ON-OFF					Selector 3 Position		
Switch Family	m-Series		e-Series	HD-Series		m-Series	e-Series	HD-Series
Function	Switches a single battery to a single load group					Switches either isolated battery bank to loads		
Battery Inputs	1					2	2	
Switch Positions	2					3	3	
Battery Combine	--					--	--	
Make Before Break	N/A		N/A		N/A		N/A	
Cranking Rating (30 sec.)	900A		1,200A	1,750A		900A	1,200A	1,600A
Intermittent Rating (5 min.)	500A		600A	900A		500A	600A	700A
Continuous Rating	300A		350A	600A		300A	350A	500A
Voltage Max. Operating	48V DC		48V DC	32V DC		32V DC	32V DC	
Width	2.83" (72 mm)		3.85" (98 mm)		2.83" (72 mm)		3.85" (98 mm)	
Height	2.83" (72 mm)		3.85" (98 mm)		2.83" (72 mm)		3.85" (98 mm)	
Mounting Centers	2.18" (55 mm)		3.00" (76 mm)		2.18" (55 mm)		3.00" (76 mm)	
Mounting Hardware	#10 (M5) Screws		1/4" (M6) Screws		#10 (M5) Screws		1/4" (M6) Screws	
Terminal Stud Size	3/8"-16 (M10)			1/2" (M12)		3/8"-16 (M10)	3/8"-16 (M10)	1/2" (M12)
Terminal Stud Length	7/8" (22 mm)					7/8" (22 mm)		
Max. Terminal Stud Torque	120 in-lb (13.56 N-m)		140 in-lb (15.82 N-m)	220 in-lb (24.86 N-m)		120 in-lb (13.56 N-m)	140 in-lb (15.82 N-m)	220 in-lb (24.86 N-m)
Terminal Stud Material	Tin-plated copper					Tin-plated copper		
Cable Size to Meet Ratings *	4/0 AWG (120 mm <sup>2</sup> )					4/0 AWG (120 mm <sup>2</sup> )		
Cable Clearance for 4/0 Cables	1.12" (28.4 mm)		1.10" (27.9 mm)		1.12" (28.4 mm)		1.10" (27.9 mm)	
Ignition Protected	UL 1500, SAE J1171					UL 1500, SAE J1171		
Ingress Protected	IP66**					IP66**		

These diagrams are intended for reference of how the switches operate and are not wiring diagrams. Consult an ABYC certified marine electrical professional for system design and circuit protection.

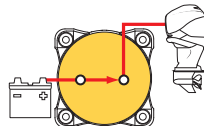

Switch set to ON

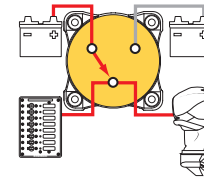

Switch set to 1

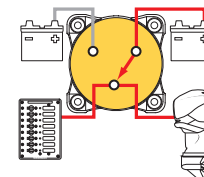

Switch set to 2

\* Reducing cable size will reduce current rating

\*\* See inside back cover



6007	9001E, 9002E	3002, 3003	6010	5510E	6011	5511E
30	32	34	30	32	30	32

Selector 4 Position

Dual Circuit™

Dual Circuit Plus™

Selector 4 Position			Dual Circuit™		Dual Circuit Plus™	
m-Series	e-Series	HD-Series	m-Series	e-Series	m-Series	e-Series
Switches isolated battery banks to all loads or combines battery banks to all loads			Simultaneously switches two isolated battery banks		Simultaneously switches two isolated battery banks or combines battery banks to all loads	
2			2		2	
4			2		3	
Yes			--		Yes	
Yes			--		Yes	
900A	1,200A	1,600A	675A per circuit	700A per circuit	675A per circuit	700A per circuit
500A	600A	700A	450A per circuit	525A per circuit	450A per circuit	525A per circuit
300A	350A	500A	300A per circuit	350A per circuit	300A per circuit	350A per circuit
32V DC			32V DC		32V DC	
2.83" (72 mm)	3.85" (98 mm)		2.83" (72 mm)	3.85" (98 mm)	2.83" (72 mm)	3.85" (98 mm)
2.83" (72 mm)	3.85" (98 mm)		2.83" (72 mm)	3.85" (98 mm)	2.83" (72 mm)	3.85" (98 mm)
2.18" (55 mm)	3.00" (76 mm)		2.18" (55 mm)	3.00" (76 mm)	2.18" (55 mm)	3.00" (76 mm)
#10 (M5) Screws	1/4" (M6) Screws		#10 (M5) Screws	1/4" (M6) Screws	#10 (M5) Screws	1/4" (M6) Screws
3/8"-16 (M10)	3/8"-16 (M10)	1/2" (M12)	3/8"-16 (M10)		3/8"-16 (M10)	
7/8" (22 mm)			7/8" (22 mm)		7/8" (22 mm)	
120 in-lb (13.56 N-m)	140 in-lb (15.82 N-m)	220 in-lb (24.86 N-m)	120 in-lb (13.56 N-m)	140 in-lb (15.82 N-m)	120 in-lb (13.56 N-m)	140 in-lb (15.82 N-m)
Tin-plated copper			Tin-plated copper		Tin-plated copper	
4/0 AWG (120 mm <sup>2</sup> )			4/0 AWG (120 mm <sup>2</sup> )		4/0 AWG (120 mm <sup>2</sup> )	
1.12" (28.4 mm)	1.10" (27.9 mm)		1.12" (28.4 mm)	1.10" (27.9 mm)	1.12" (28.4 mm)	1.10" (27.9 mm)
UL 1500, SAE J1171			UL 1500, SAE J1171		UL 1500, SAE J1171	
IP66**			IP66**		IP66**	

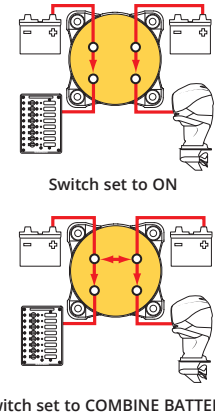
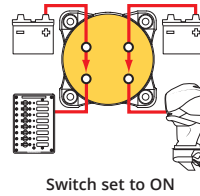
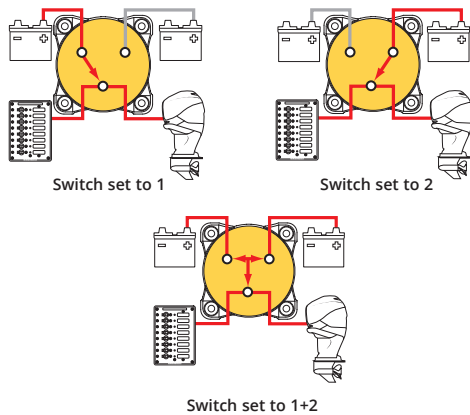

## Battery Management Panels

Easily manage multiple battery bank systems

- Isolates the Start circuit from the House circuit
- Allows emergency cross connect between isolated battery banks
- Protects electronics from sags and spikes caused by engine cranking

**Regulatory** Meets UL 1500 and SAE J1171 external ignition protection requirements

**IGNITION PROTECTED**

**Related Products**



M-ACR page 46



SI-ACR page 47

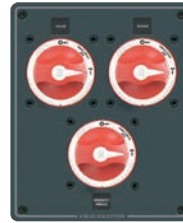

8280



8080

Part #	8280	8080
<b>Description</b>	Dual Battery Bank-Traditional Metal	Dual Battery Bank-Traditional Metal
<b>Voltage Max. Operating</b>	48V DC	48V DC
<b>Circuit Breakers</b>	--	1 x C-Series Flat Rocker, MAIN 100A
<b>Battery Switch</b>	3 x 6006	2 x 6006
<b>Width x Height in (mm)</b>	6.25 (158.75) x 7.50 (190.50)	5.25 (133.35) x 6.50 (165.10)
<b>Depth in (mm)</b>	2.25 (57.15)	3.00 (76.20)
<b>Labels Included</b>	Square Format Label Set 4218	Square Format Label Set 4218



1408



8686



8690

Part #	1408	8686	8690
<b>Description</b>	Dual Battery Bank - 360 Panel	Dual Battery Bank - Traditional Metal	Dual Battery Bank - Traditional Metal
<b>Nominal Voltage</b>	12V DC	12V / 24V DC	12V / 24V DC
<b>24-Hour Circuits</b>	3 unswitched	2 unswitched	2 unswitched
<b>Circuit Breakers</b>	1 x C-Series Flat Rocker, MAIN 100A 3 x Push Button Reset-Only - BRANCH 15A	1 x C-Series Flat Rocker, MAIN 100A 2 x Push Button Reset-Only - BRANCH 15A, spare apertures for additional breakers	1 x C-Series Flat Rocker, MAIN 100A 2 x Push Button Reset-Only - BRANCH 15A, spare apertures for additional breakers
<b>Battery Switch</b>	6011200	6011	5511E
<b>Width x Height in (mm)</b>	4.88 (123.83) x 7.75 (196.85)	4.50 (114.30) x 7.50 (190.50)	5.25 (133.35) x 8.00 (203.20)
<b>Depth in (mm)</b>	3.50 (88.90)	3.25 (82.55)	3.00 (76.20)
<b>LEDs</b>	ON Indicating LEDs in all circuits	ON Indicating LEDs in all circuits	ON Indicating LEDs in all circuits
<b>Labels Included</b>	Square Format Label Set 4218	24-hour Round Label Set & Square Format Label Set 4218	24-hour Round Label Set & Square Format Label Set 4218



1494



8689



8693

Part #	1494	8689	8693
<b>Description</b>	Mini Add-A-Battery - 360 Panel	Triple Battery Bank - Traditional Metal	Triple Battery Bank - Traditional Metal
<b>Nominal Voltage</b>	12V DC	12V / 24V DC	12V / 24V DC
<b>24-Hour Circuits</b>	--	3 unswitched	4 unswitched
<b>Circuit Breakers</b>	--	1 x C-Series Flat Rocker, MAIN 100A 3 x Push Button Reset-Only - BRANCH 15A, spare apertures for additional breakers	1 x C-Series Flat Rocker, MAIN 100A 4 x Push Button Reset-Only - BRANCH 15A, spare apertures for additional breakers
<b>Battery Switch</b>	6011	2 x 6011	2 x 5511E
<b>Automatic Charging Relay</b>	7601	--	--
<b>Width x Height in (mm)</b>	4.88 (123.83) x 7.75 (196.85)	7.25 (184.15) x 8.00 (203.20)	10.50 (266.70) x 8.00 (203.20)
<b>Depth in (mm)</b>	3.25 (82.55)	3.25 (82.55)	3.50 (88.90)
<b>LEDs</b>	--	ON Indicating LEDs in all circuits	ON Indicating LEDs in all circuits
<b>Labels Included</b>	--	24-hour Round Label Set & Square Format Label Set 4218	24-hour Round Label Set & Square Format Label Set 4218



## L-Series Solenoid Switches

150A or 250A switches are remotely activated using a low amp switch and smaller gauge wire

- Continuous duty, SPST - Normally Open
- Hermetically sealed contacts
- Activated by a remote ON-OFF switch 8230 - sold separately (p. 92)
- Coil control circuit minimizes heating and amperage draw

Part #	7765	9012
Description	150A L-Series Solenoid Switch	250A L-Series Solenoid Switch
Operating Temperature	-40°C to +85°C	-55°C to +85°C
Coil Circuit Connection	22 AWG Tinned Wire	20 AWG Tinned Wire
Voltage Nominal	12/24V DC	12/24V DC
Coil Function	Normally Open	Normally Open
Operating Current Changing State	3.8A	3.6A
Operating Current Continuous	0.13A @ 12V, 0.07A @ 24V	0.13A @ 12V, 0.07A @ 24V
Voltage Input	9V-36V DC	9V-36V DC
Terminal Studs	M8 (accepts 5/16" terminals)	M8 (accepts 5/16" terminals)
Terminal Stud Torque	90 in-lb (10 Nm) max.	90 in-lb (10 Nm) max.
Mounting Screws	#10 or M5	#10 or M5
Mounting Screw Torque	15-30 in-lb (1.7-3.4 Nm)	15-35 in-lb (1.7-4 Nm)
Weight	0.95 lb (0.43 kg)	0.9 lb (0.41 kg)
<b>Contact Rating</b>		
Continuous Rating	150A*	250A**
Intermittent Rating (5 min.)	225A*	275A**
Cranking Rating (30 sec.)	600A*	1000A**
Voltage Maximum	320V DC	800V DC

\*2 AWG Cable in 50°C ambient  
 \*\*1/0 AWG Cable in 50°C ambient

**Regulatory** CE marked, IP67-protected against immersion up to 1 meter for 30 minutes (see inside back cover)  
 Ignition protected - ISO 8846 and SAE J1171.  
 9012 ONLY - UL Certified - UL 508 Industrial Control Equipment

**IGNITION PROTECTED**

### 9012 Wire Size and Current Ratings (50°C Ambient)

Wire Size	Cranking 30 sec.	Intermittent 5 min.	Continuous
1/0 AWG	1000A	275A	250A
2/0 AWG (70 mm <sup>2</sup> )	1000A	400A	300A

For the full list of specifications see page 52

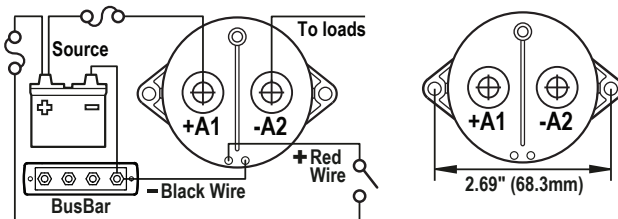

### Related Product



ON-OFF Switch 8230  
 page 92



7765



9012

## TECH TIP

### Solenoid vs Remote Battery Switch

**Solenoid:** An electronic switch with no manual control, for circuits where a manual battery disconnect is offered elsewhere in the circuit.

**Remote Battery Switch:** A solenoid or relay with a manual control switch allowing for switching if control circuit is compromised and for service lockout.

## ML-Series Solenoid Switches

500A magnetic latching solenoid provides switching under load where manual control is not required



Remote Control Contura Switch included in retail package



Deutsch DTM Cable End now offered for both retail and bulk units. Other connector plugs are available for high volume OEM applications.



- Silver alloy contacts provide high reliability for switching live loads
- LED output to remotely indicate switch state - requires optional LED (p. 153) or Remote Control Contura Switch with integrated LED (included in retail package)
- 3/8"-16 tin-plated copper studs for maximum conductivity and corrosion resistance
- One-piece stainless flange nuts for safe and secure connections
- Label recesses for circuit identification
- Retail package includes Remote Control Contura Switch (p. 93)

**Regulatory** CE marked, meets ISO 8846 and SAE J1171 external ignition protection requirements, IP66 - protected against powerful water jets (see inside back cover)

**IGNITION PROTECTED**

Part #	Contact Voltage	Control Voltage	Control Signal	Cable End
7701	0-64V	9-16V	12V Momentary	Stripped Wire
7701100	0-64V	9-16V	12V Momentary	Deutsch DTM
7703	0-64V	18-32V	24V Momentary	Stripped Wire
7703100	0-64V	18-32V	24V Momentary	Deutsch DTM
7718	9-16V	9-16V	12V Continuous	Stripped Wire
7718100	9-16V	9-16V	12V Continuous	Deutsch DTM
7719	18-32V	18-32V	24V Continuous	Stripped Wire
7719100	18-32V	18-32V	24V Continuous	Deutsch DTM

### Wire Size and Current Ratings

Wire Size	Cranking 30 sec.	Intermittent 5 min.	Continuous (UL 1107)
2/0 AWG (70 mm <sup>2</sup> )	1,000A	400A	225A
4/0 AWG (120 mm <sup>2</sup> )	1,100A	400A	300A
2x 4/0 AWG (2x 120 mm <sup>2</sup> )	1,450A	700A	500A

For the full list of specifications see page 52  
For the dimensioned drawing see page 43

### Related Products



## m-LVD Low Voltage Disconnect

Senses low battery voltage and disconnects non-critical loads, saving power to start engine



Remote Control Contura Switch included in retail package

**VIDEO**  
blueseas.com/video

- Status light provides warning of low voltage state prior to disconnect
- Alarm output for audible warning of low voltage state prior to disconnect (optional alarm required)
- One-piece stainless flange nuts for safe and secure connections
- Remote Control Switch functions:
  - Adjusts disconnect voltage
  - Temporarily delays circuit disconnect for 10 minutes
  - Temporarily disconnects circuits until voltage rises
  - Silences alarm (optional alarm required)
- Retail package includes Remote Control Contura Switch 7928 (p. 93)

Part #	7635
Intermittent Rating: 5 min.	115A
Continuous Rating	65A
Nominal Voltage	12V DC
Cable Size (to meet current ratings)	6 AWG (16mm <sup>2</sup> )
Terminal Stud Size	1/4"-20 (M6)
Disconnect Voltage	11.3V-12.1V Adjustable
Reconnect Voltage	13V DC
Regulatory	Meets ISO 8846 and SAE J1171 external ignition protection requirements

**IGNITION PROTECTED**

For the full list of specifications see page 53

### System Diagram

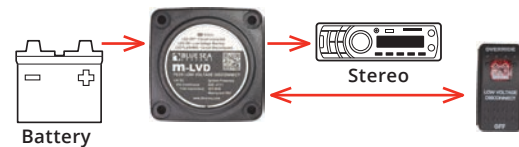

### Related Products



## Automatic Timer Disconnect (ATD)

Select from 4 methods to manage your batteries: Timer Disconnect, Low Voltage Disconnect, Automatic Charging Relay, or Solenoid

### Timer Disconnect

- 12V signal triggers relay to connect battery power to devices
- When signal is removed the timer is activated and will disconnect devices after a preset time
- Timer ranges from 15 minutes to 4 hours
- Optional charge sense can be used instead of 12V signal to reduce wiring
- Test mode disconnects devices after 5 seconds to confirm relay and timer are operational

### Low Voltage Disconnect

- Senses low battery voltage and automatically disconnects devices to save power
- Adjustable voltage setting at 11.0V, 11.5V, or 12.0V
- Low voltage setting can be used in conjunction with timer disconnect
- Low voltage will disconnect devices prior to preset time to preserve battery power

### Automatic Charging Relay

- Automatically combines two battery banks for charging off a single charging source (i.e. alternator)
- Isolates batteries when charging source is not present or discharging
- Single side sensing design only monitors the voltage of the start battery
- Ideal for auxiliary batteries that are AGM or larger than the start battery

### Solenoid

- 12V signal will connect or disconnect relay without any time delay



cover off

Part #	7615
Nominal Voltage	12V DC
Input Voltage Range	9.5-16V
Continuous Rating	120A
Intermittent Rating: 5 min.	210A
Amperage Operating Current (Combine)	175mA
Amperage Operating Current (Open)	4mA
Cable Size (to meet current ratings)	1 AWG (50mm <sup>2</sup> )
Maximum Cable Size	1/0 AWG (50mm <sup>2</sup> )
Terminal Stud Size	3/8"-16 (M10)
Terminal Stud Torque	140 in-lb (15.82Nm)
Time Range	15 Minutes - 4 Hours
Regulatory	CE marked, Meets ISO 8846 and SAE J1171 external ignition protection requirements IP67-protected against immersion up to 1 meter for 30 minutes (see inside back cover)

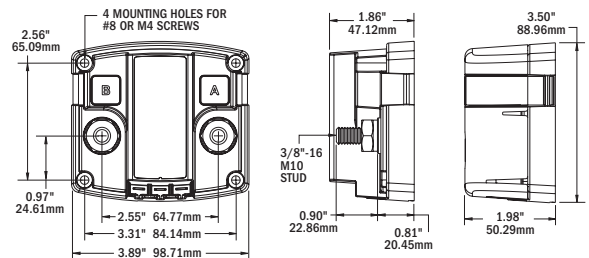

**IGNITION PROTECTED**

For the full list of specifications see page 53



### Related Products



MRBF Terminal Fuse Blocks page 68



LEDs page 153



## Remote Battery Switches

A Remote Battery Switch (RBS) is a 500A relay and remote control switch connected by small gauge single wire. High amperage switching is achieved with the relay mounted next to the batteries and controlled either manually by a switch on the remote battery switch or by the remote switch mounted in an accessible location. Read the TECH Tip, Solenoid vs Remote Battery Switch RBS Explained on page 39.

The installed cost of a remote battery compared to manual battery switch may not be that different. The cost savings from eliminating long runs of expensive large gauge battery cables and replacing them with light gauge control wires can often offset the cost of a remote battery switch.

### 4 Position Selector Switch

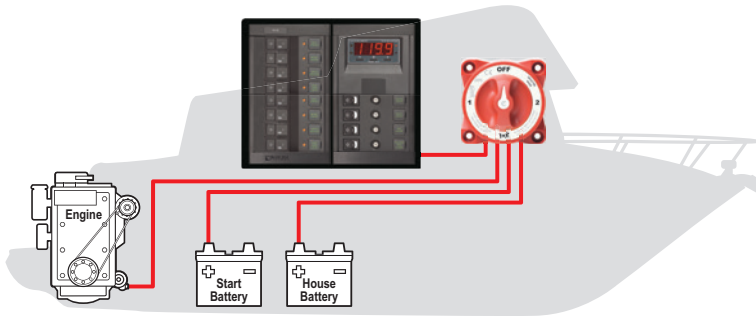

#### Traditional Battery Switch (40' of 4/0 AWG Cable)

- Long runs of large cable create voltage drop
- Decreased power to engine
- Increases weight
- More expensive

#### ML-Series Remote Battery Switches and Automatic Charging Relay

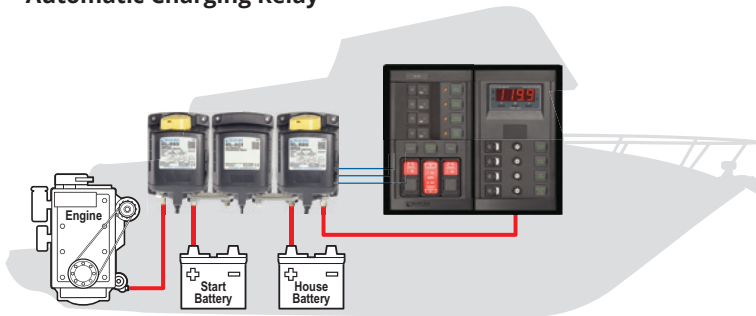

#### Remote Battery Management with small control wire (5' of 4/0 AWG Cable)

- Minimizes cable run and voltage drop
- Maximizes power to engine
- Reduces weight
- Saves money

## TECH TIP

### Mastervolt Lithium Ion Battery System

Mastervolt utilizes Blue Sea Systems ML Remote Battery Switches (ML-RBS) on their Lithium Ion Battery systems. The advanced Lithium Ion Batteries have a built in Battery Management System (BMS) with active cell balancing. The ML-RBS is utilized for its rapid ability to disconnect the batteries under full load. At any time the Mastervolt BMS can trigger the ML-RBS to safely disconnect the batteries. Once the system is restored the ML-RBS can be re-connected for quick operation. The latching operation of the ML-RBS means that no amperage is consumed during an open or closed state, which further prolongs the available power in the Lithium Ion Batteries. The override knob allows the ML-RBS to be manually disconnected for safe servicing of the battery system. With a rating of 500A continuous, the ML-RBS pairs perfectly with all of the Mastervolt Lithium Ion Batteries.

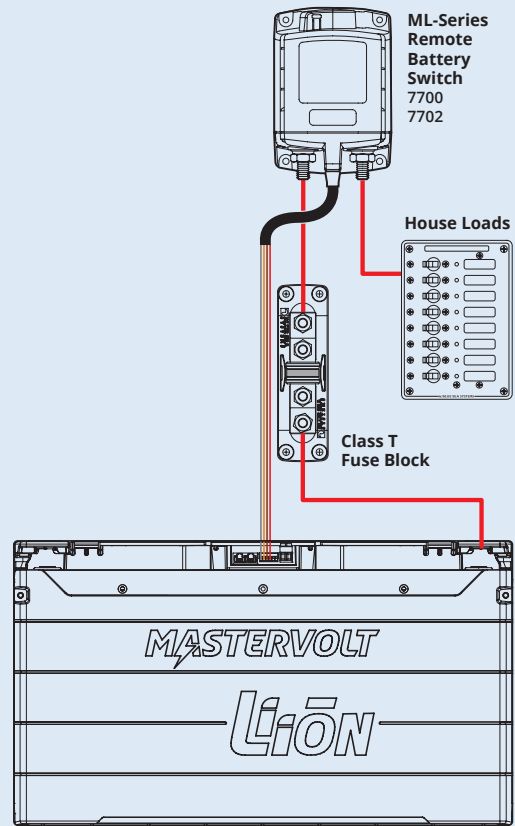

## ML-Series Remote Battery Switches

500A magnetic latching switch provides high amperage switching under load, manually or from remote locations

- Silver alloy contacts provide high reliability for switching live loads
- LED output to remotely indicate switch state - requires optional LED (p. 153) or Remote Control Contura Switch with integrated LED (included in retail package)
- 3/8"-16 tin-plated copper studs for maximum conductivity and corrosion resistance
- One-piece stainless flange nuts ensure safe and secure connections
- Label recesses for circuit identification
- Retail package includes a Remote Control Contura Switch (p. 93)

Terminal Stud Size	3/8"-16 (M10)
Maximum Terminal Stud Torque	140 in-lb (15.8 N•m)
Cable Size (to meet current ratings)	4/0 AWG (120mm <sup>2</sup> )
Terminal Ring Diameter Clearance	1.12" (28.4 mm)
Regulatory	CE marked, meets ISO 8846 and SAE J1171 external ignition protection requirements IP66 - protected against powerful water jets (see inside back cover)

**IGNITION PROTECTED**

### Wire Size and Current Ratings

Wire Size	Cranking 30 sec.	Intermittent 5 min.	Continuous (UL 1107)
2/0 AWG (70 mm <sup>2</sup> )	1,000A	400A	225A
4/0 AWG (120 mm <sup>2</sup> )	1,100A	400A	300A
2x 4/0 AWG (2x 120 mm <sup>2</sup> )	1,450A	700A	500A

Part #	Contact Voltage	Control Voltage	Signal Voltage	Cable End
7700	0-64V	9-16V	12V Momentary	Stripped Wire
7700100	0-64V	9-16V	12V Momentary	Deutsch DTM / Amphenol ATM
7702	0-64V	18-32V	24V Momentary	Stripped Wire
7702100	0-64V	18-32V	24V Momentary	Deutsch DTM / Amphenol ATM
7713	9-16V	9-16V	12V Continuous	Stripped Wire
7713100	9-16V	9-16V	12V Continuous	Deutsch DTM / Amphenol ATM
7717	18-32V	18-32V	24V Continuous	Stripped Wire
7717100	18-32V	18-32V	24V Continuous	Deutsch DTM / Amphenol ATM
9160	Paralleling link bus			

For the full list of specifications see page 52

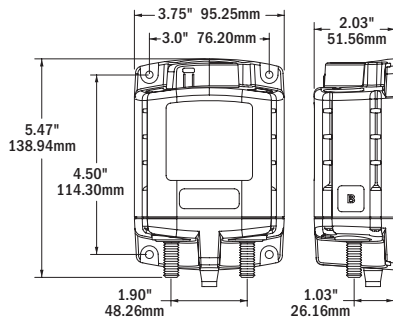

Remote Control Contura Switch included in retail package



Deutsch DTM Cable End now offered for both retail and bulk units. Other connector plugs are available for high volume OEM applications.



7700



7713

## TECH TIP

### ML-Series Solenoid & RBS Rating

A number of ML-Series Solenoids and Remote Battery Switches are rated to 64V DC, making them ideal for use in 36V DC and 48V DC nominally-rated systems. The 64V DC rating applies only to the contact voltage, while maintaining the existing 12V DC or 24V DC signal voltage, making them ideal for use in multi-voltage systems like solar or golf-carts. The higher voltage rating was tested to 2,000 live-switching cycles at maximum operating voltage per UL 1107 requirements.

### Related Products



Paralleling Link Bus 9160 see table

ML-Series ACR page 51

Remote Control Switch 360 Panels page 94

LEDs page 153

Stud Mount Insulators page 108

## Intro to Automatic Charging Relays

Automatic Charging Relay Operation

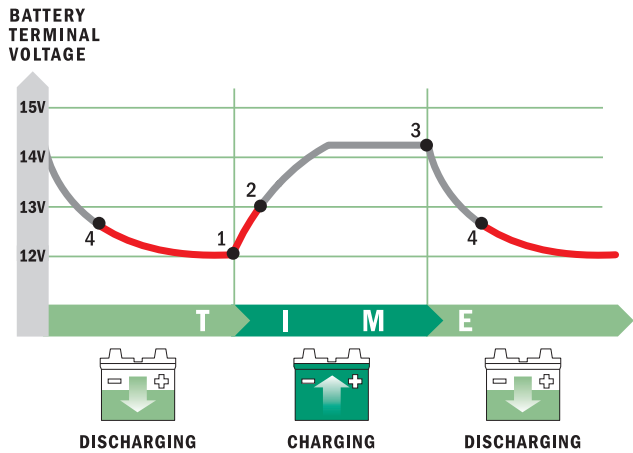

**LEGEND**

- ACR OPEN - Batteries are isolated.
- ACR COMBINED - Batteries are connected and are both charging.

1. ACR relay is open and batteries are isolated. Voltage begins to rise slowly after engine starts or battery charger is turned on.
2. When voltage rises to COMBINE voltage 13.0V in this example, ACR relay closes, connecting and charging both batteries.
3. When engine stops or battery charger is turned off, voltage rapidly begins falling.
4. When voltage falls to ISOLATE voltage 12.75V in this example ACR relay opens, isolating batteries while discharging.



## TECH TIP

### Automatic Charging Relays

In a boat or vehicle with two battery banks, it is useful to be able to charge both banks while underway. Charge management devices allow two battery banks to be charged from a single source, such as an alternator, but keep batteries isolated when not charging. If one battery becomes depleted, there will be a charged bank available for emergency starting.

There are two types of charge management devices:

**Automatic Charging Relays (ACR)** use a relay combined with a voltage sensing circuit. When a charge is being applied to a battery and the voltage rises over 13V DC, the relay closes and combines the two batteries. When the charge is taken away or the load on the battery is greater than the charging input causing the voltage to drop to 12.75V DC, the relay opens and isolates the two batteries.

#### Isolators

1. **Battery Isolators** are one-way electrical check valves that allow current to flow to, but not from, the battery. Their disadvantage is that they use diodes, which cause a voltage drop that consumes charging energy, creates heat, and causes batteries to be undercharged. Although alternators with external voltage sensing can correct for undercharging, voltage drop and heat remain a problem.
2. **Zero Drop Isolators** have more recently been developed to address the voltage drop issue of the traditional isolator but often have a higher price than either of the other two options mentioned above.

### Automatic Charging Relay vs. Battery Isolator

#### Automatic Charging Relay

Passes the current from one battery to the other resulting in a lower voltage drop than battery isolators.

.05V Drop - Batteries Fully Charged

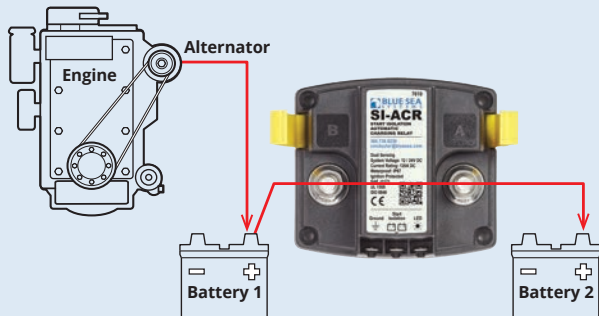

#### Battery Isolator

Splits the current between batteries.

6V Drop - Batteries Under Charged

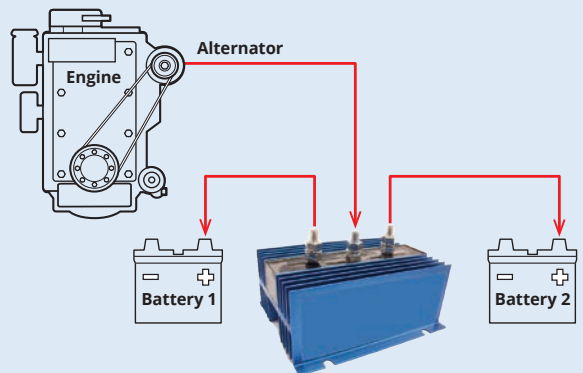



## Selection Chart

Choose the right Automatic Charging Relay for your application

1. Select an ACR that has a **Continuous** rating above the maximum alternator output rating and an **Intermittent** rating that is above the largest load on the auxiliary battery.
2. Review the **PRESET ACR SETTINGS**
3. Select the ACR with the desired **PRODUCT FEATURES**



Part #	7601	7611	7610	7620	7622
<b>Continuous</b>	65A	120A	120A	500A	500A
<b>Intermittent</b>	115A	210A	210A	700A	700A

### PRESET ACR SETTINGS

#### Combine Voltage

- Charge present and loads do not exceed charge input
- Voltage of either battery is  $\geq 13.0V$  for 2 min.
- Relay will close, combining batteries
- Combined batteries share charge

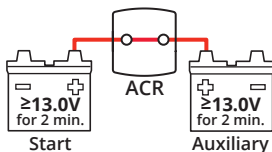

✓	✓	✓	✓	✓
---	---	---	---	---

#### Open Voltage

- No charge present or loads exceed charge input
- Combine voltage is  $\leq 12.75V$  for 30 sec.
- Relay will open, isolating batteries
- Isolated batteries do not share charge

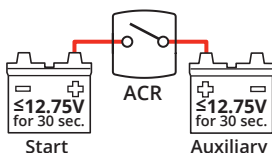

✓	✓	✓	✓	✓
---	---	---	---	---

#### Under Voltage Lockout

- Charge may or may not be present
- Voltage of either battery is  $\leq 9.5V$  (ML-ACR 9.6V)
- Relay will not close even with charge on other battery, protecting ACR and wiring from high surge current
- Isolated batteries do not share charge

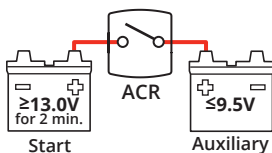

✓		✓	✓	✓
---	--	---	---	---

### PRODUCT FEATURES

#### Auxiliary Battery Priority (optional)

Condition: Engine running

- Open voltage is lowered to 12.25V from 12.75V
- Relay remains closed longer, combining batteries, to allow use of auxiliary loads for a longer period of time

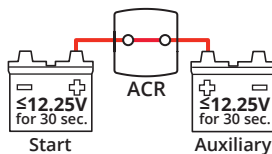

		✓		
--	--	---	--	--

#### Start Isolation (optional)

Condition: Engine starting

- Relay is open, isolating batteries
- Batteries are isolated to protect sensitive electronics from voltage sags and spikes

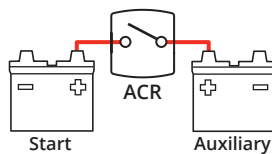

✓		✓	✓	✓
---	--	---	---	---

#### Start Assist

Condition: Engine starting – (Press Contura Switch)

- Relay is closed, combining batteries
- Batteries are combined to share power in the event of a low start battery

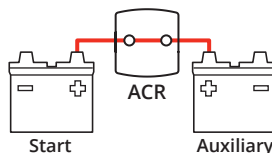

			✓	✓
--	--	--	---	---

#### Engine Isolation

Condition: Two engines are running

- One relay is open and one relay is closed
- Engine 1 Start and Engine 2 Start batteries are isolated to protect engine electronics
- If requested by engine manufacturer

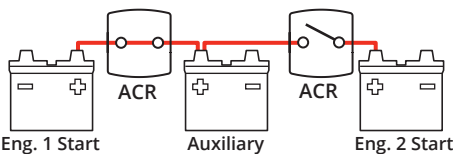

		✓		✓
--	--	---	--	---

#### Manual Override

Manual override knob provides an added level of safety allowing manual control of ON-OFF

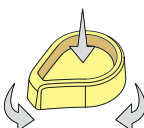

				✓
--	--	--	--	---

# M-ACR Automatic Charging Relay

## With Optional Start Isolation

Automatically combines batteries during charging, isolates batteries when discharging and when starting engines

- 65A continuous rating
- 12V/24V DC auto ranging voltage input
- Senses charging on two battery banks
- Case design allows surface, rear, or front panel mounting options
- Snap-on cover insulates terminal connections
- One-piece stainless flange nuts ensure safe and secure connections
- Integrated LED indicates ACR states
- Quick connect terminals for ground and start isolation
- Optional Start Isolation allows temporary isolation of House loads from Engine circuit during engine cranking to protect sensitive electronics from sags and spikes



Part #	7601	
Intermittent Rating: 5 min.	115A	
Continuous Rating	65A	
Amperage Operating Current (Combine)	90mA	
Amperage Operating Current (Open)	15mA	
Nominal Voltage	12V / 24V DC	
Cable Size (to meet current ratings)	6 AWG (16mm <sup>2</sup> )	
Maximum Cable Size	1/0 AWG (50mm <sup>2</sup> )	
Terminal Stud Size	1/4"-20 (M6)	
Terminal Stud Length	7/16" (11 mm)	
<b>Relay Contact Position</b>	<b>12V DC</b>	<b>24V DC</b>
Combine (30 sec.)	13.6V DC	27.2V DC
Combine (2 min.)	13.0V DC	26.0V DC
Open (10 sec.)	12.35V DC	24.7V DC
Open (30 sec.)	12.75V DC	25.5V DC
Over Voltage Lockout	16.0V DC	--
Under Voltage Lockout	9.5V DC	19.0V DC
Under Voltage Recovery	10.0V DC	20.0V DC
Regulatory	CE marked, ISO 8846, meets SAE J1171 external ignition protection requirements IP67 - protected against immersion up to 1 meter for 30 minutes (see inside back cover)	

**IGNITION PROTECTED**

For the full list of specifications see page 53

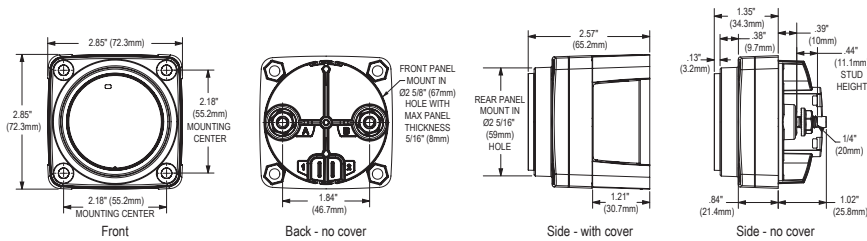

### Mounting Options



Rear



Front



Surface

### Related Products

				
Mini-Series Battery Switch page 30	Mini Add-A-Battery 360 Panel page 38	Mini Add-A-Battery page 48	MRBF Terminal Fuse Blocks page 68	WeatherDeck OFF-ON Toggle Switch page 96

# SI-ACR Automatic Charging Relay

## With Optional Start Isolation

Automatically combines batteries during charging, isolates batteries when discharging and when starting engines

- 120A continuous rating to support high output alternators
- 12V/24V DC auto ranging voltage input
- Senses charging on two battery banks
- Side and bottom knockouts for cable connections
- Clip-on cover insulates terminal connections
- Studs accept multiple cable terminals
- One-piece stainless flange nuts ensure safe and secure connections
- Integrated LED indicates ACR status
- Quick connect terminals for ground and optional features
- Optional Start Isolation allows temporary isolation of House loads from Engine circuit during engine cranking to protect sensitive electronics from sags and spikes
- Remote LED indicates ACR states - requires optional LED (p. 153)



cover off

Part #	7610	
Intermittent Rating: 5 min.	210A	
Continuous Rating	120A	
Amperage Operating Current (Combine)	175mA	
Amperage Operating Current (Open)	15mA	
Nominal Voltage	12V / 24V DC	
Cable Size (to meet current ratings)	1 AWG (50mm <sup>2</sup> )	
Maximum Cable Size	1/0 AWG (50mm <sup>2</sup> )	
Terminal Stud Size	3/8"-16 (M10)	
<b>Relay Contact Position</b>	<b>12V DC</b>	<b>24V DC</b>
Combine (30 sec.)	13.6V DC	27.2V DC
Combine (2 min.)	13.0V DC	26.0V DC
Open (10 sec.)	12.35V DC	24.7V DC
Open (30 sec.)	12.75V DC	25.5V DC
Over Voltage Lockout	16.0V DC	30.0V DC
Under Voltage Lockout	9.5V DC	19.0V DC
Under Voltage Recovery	10.0V DC	20.0V DC
Regulatory	CE marked, ISO 8846, meets UL 1500 and SAE J1171 external ignition protection requirements IP67 - protected against immersion up to 1 meter for 30 minutes (see inside back cover)	

**IGNITION PROTECTED**

For the full list of specifications see page 53  
 For the dimensioned drawing see page 41

### Related Products



e-Series Battery Switch page 32



Add-A-Battery page 48



MRBF Terminal Fuse Blocks page 68



WeatherDeck OFF-ON Toggle Switch page 96



LEDs page 153



### Mini Add-A-Battery Kit

Simplifies switching and automates charging for a 65A, two battery bank solution for outboard powered boats

- For alternators up to 65A
- Includes the m-Series Dual Circuit Plus Battery Switch 6011 (p. 30) and the m-ACR Automatic Charging Relay 7601 (p. 46)

#### m-Series Dual Circuit Plus™ Battery Switch

- Switches two battery banks simultaneously while maintaining battery bank isolation
- Can combine two battery banks in the event of a low start battery
- IP66 - protected against powerful water jets (see inside back cover)

#### m-ACR Automatic Charging Relay

- Automatically combines battery banks when charging and isolates when discharging
- Start isolation protects sensitive electronics
- Dual Sensing senses charge on two battery banks
- IP67 - protected against immersion up to 1 meter for 30 minutes (see inside back cover)

Part #	Description	Retail Package
7649	Mini Add-A-Battery Kit	Clam
7649003	Mini Add-A-Battery Kit	Box



7649

7649003

**IGNITION PROTECTED**

**VIDEO**  
bluese.com/video

### Add-A-Battery Kit

Simplifies switching and automates charging for a 120A, two battery bank solution for inboard and outboard powered boats

- For alternators up to 120A
- Includes the e-Series Dual Circuit Plus Battery Switch 5511E (p. 32) and the SI-ACR Automatic Charging Relay 7610 (p. 47)

#### e-Series Dual Circuit Plus™ Battery Switch

- Switches two battery banks simultaneously while maintaining battery bank isolation
- Can combine two battery banks in the event of a low start battery
- IP66 - protected against powerful water jets (see inside back cover)

#### SI-ACR Automatic Charging Relay

- Automatically combines battery banks when charging and isolates when discharging
- Start isolation protects sensitive electronics
- Dual Sensing senses charge on two battery banks
- IP67 - protected against immersion up to 1 meter for 30 minutes (see inside back cover)

Part #	Description	Retail Package
7650	Add-A-Battery Kit	Clam
7650003	Add-A-Battery Kit	Box



7650

7650003

**IGNITION PROTECTED**

**VIDEO**  
bluese.com/video

#### Related Products



m-Series Battery Switch page 30

m-ACR page 46

WeatherDeck OFF-ON Toggle Switch page 96

Add-A-Battery 360 Panel page 38

#### Related Products



e-Series Battery Switch page 32

SI-ACR page 47

MRBF Terminal Fuse Blocks page 68

WeatherDeck OFF-ON Toggle Switch page 96

## TECH TIP

### Add-A-Battery Kits Explained

Avoid the inconvenience and cost of a tow by adding a second battery to your electrical system.

The Add-A-Battery Kits include a Dual Circuit Plus™ Battery Switch and an Automatic Charging Relay. These components simplify switching and automate charging. Simply turn the battery switch ON when you arrive and OFF when you leave.

Adding a second battery prevents getting stranded with a dead battery by isolating the Start battery from the House loads that can quickly discharge a battery. The Add-A-Battery Kits offer a simple way to control switching with the Dual Circuit Plus™ Battery Switch and automatically shares a single source of charging between two batteries with the Automatic Charging Relay.

#### Engine On

ACR combines batteries sharing the charge with House battery

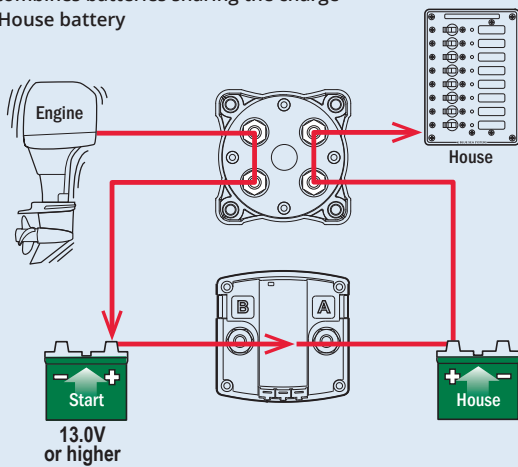

#### Engine Off

ACR isolates batteries when discharging and when starting engine

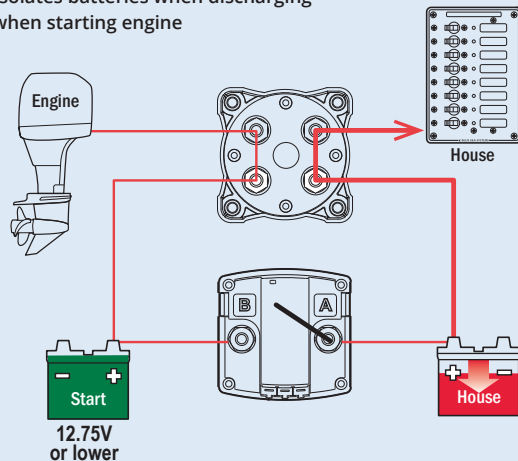

#### DC Current

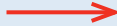

The diagrams above illustrate how the 7650 and 7649 Add-A-Battery Kits work and are intended for reference only. Consult an ABYC certified marine electrical professional for system design and circuit protection.

## Mini Add-A-Battery Plus Kits

A complete small boat battery management system. Charge two batteries at or away from the dock

- For alternators up to 65A
- Includes an m-Series Dual Circuit Plus™ Battery Switch 6011 (p. 30) and a BatteryLink® Charger (p. 22)

#### m-Series Dual Circuit Plus Battery Switch

- Switches two battery banks simultaneously while maintaining battery bank isolation
- Can combine two battery banks in the event of a low start battery
- IP66 - protected against powerful water jets (see inside back cover)

#### BatteryLink Charger

- Integrated ACR provides DC charging from engine alternator
- AC plug-in while at the dock
- Battery temperature compensation prolongs battery life
- Includes a remote LED indicator
- Start isolation protects sensitive electronics
- IP67 - protected against immersion up to 1 meter for 30 minutes (see inside back cover)

Part #	Description	Plug Style
7655	Mini Add-A-Battery Plus Kit	North American: NEMA 5-15P



7655

### IGNITION PROTECTED

For the AC & DC Battery Charging Explained TECH Tip see page 22

#### Related Products



BatteryLink Chargers page 22



m-Series Battery Switch page 30

## BatteryLink® Automatic Charging Relay (ACR)

### With Optional Auxiliary Battery Priority

Automatically shares single source of charge with Auxiliary Battery

- 120A continuous rating to support high output alternators
- 12V/24V DC auto ranging voltage input
- Senses charging on two battery banks
- Side and bottom knockouts for cable connections
- Clip-on cover insulates terminal connections
- Studs accept multiple cable terminals
- One-piece stainless flange nuts ensure safe and secure connections
- Integrated LED indicates ACR status
- Quick connect terminals for ground and optional features
- Optional Auxiliary Battery Priority connection shares the alternator charge with the Auxiliary battery longer when the engine is running to allow the use of auxiliary loads for an extended period of time
- Remote LED remotely indicates ACR states - requires optional LED (p. 153)

Part #	7611	
Intermittent Rating: 5 min.	210A	
Continuous Rating	120A	
Amperage Operating Current (Combine)	175mA	
Amperage Operating Current (Open)	15mA	
Nominal Voltage	12V / 24V DC	
Cable Size (to meet current ratings)	1 AWG (50mm <sup>2</sup> )	
Maximum Cable Size	1/0 AWG (50mm <sup>2</sup> )	
Terminal Stud Size	3/8"-16 (M10)	
Maximum Battery Size	850 CCA	
<b>Relay Contact Position</b>	<b>12V DC</b>	<b>24V DC</b>
Combine (30 sec.)	13.6V DC	27.2V DC
Combine (2 min.)	13.0V DC	26.0V DC
Open Low (30 sec.)	12.75V DC	25.5V DC
Over Voltage Lockout	16.0V DC	--
<b>Optional Auxiliary Priority</b>		
Open Low (30 sec.)	12.25V DC	24.5V DC
Regulatory	CE marked, ISO 8846, UL 1500, meets SAE J1171 external ignition protection requirements IP67 - protected against immersion up to 1 meter for 30 minutes (see inside back cover)	

**IGNITION PROTECTED**

For the full list of specifications see page 53  
For the dimension drawing see page 41



cover off



### Related Products



E-Series Battery Switch page 32



MRBF Terminal Fuse Blocks page 68



WeatherDeck OFF-ON Toggle Switch page 96



LEDs page 153



## ML-Series Automatic Charging Relays (ACR)

500A magnetic latching relay automatically combines batteries during charging and isolates batteries when discharging and when starting engine

- Magnetic Latching (ML) relay draws very low current in the ON state
- Start Isolation (SI) can be configured for temporary isolation of House loads from Engine circuit during engine cranking to protect sensitive electronics
- Engine Isolation (EI) can be configured for isolation of two engines while both are running to protect engine electronics and maximize alternator output
- Manual override knob provides an added level of safety allowing control with or without power and offering LOCKED OFF capability for servicing
- Senses charging on two battery banks
- LED output to remotely indicate switch state - requires optional LED (p. 153) or Remote Control Contura Switch with integrated LED (included in retail package)
- 3/8"-16 tin-plated copper studs for maximum conductivity and corrosion resistance
- One-piece stainless flange nuts ensure safe and secure connections
- Silver alloy contacts provide high reliability for live switching
- Retail packaging includes a Remote Control Contura Switch (p. 93)

Live Current Switching	300A @ 12V DC-10,000 Cycles	
Relay Contact Position	12V DC	24V DC
Combine (30 sec.)	13.5V DC	27.0V DC
Combine (2 min.)	13.0V DC	26.0V DC
Open (10 sec.)	12.35V DC	24.7V DC
Open Low (30 sec.)	12.75V DC	25.5V DC
Over Voltage Lockout	16.2V DC	32.4V DC
Under Voltage Lockout	9.6V DC	19.2V DC
Under Voltage Recovery	10.0V DC	20.0V DC
Regulatory	CE marked, meets ISO 8846 and SAE J1171 external ignition protection requirements IP66 - protected against powerful water jets (see inside back cover)	

**IGNITION PROTECTED**

### Wire Size and Current Ratings

Wire Size	Cranking 30 sec.	Intermittent 5 min.	Continuous (UL 1107)
2/0 AWG (70 mm <sup>2</sup> )	1,000A	400A	225A
4/0 AWG (120 mm <sup>2</sup> )	1,100A	400A	300A
2x 4/0 AWG (2x 120 mm <sup>2</sup> )	1,450A	700A	500A

Part #	Coil Volts	Cable End	Manual Control
7620	12V DC	Stripped Wire	No
7620100	12V DC	Deutsch DTM / Amphenol ATM	No
7622	12V DC	Stripped Wire	Yes
7622100	12V DC	Deutsch DTM / Amphenol ATM	Yes
7621	24V DC	Stripped Wire	No
7621100	24V DC	Deutsch DTM / Amphenol ATM	No
7623	24V DC	Stripped Wire	Yes
7623100	24V DC	Deutsch DTM / Amphenol ATM	Yes

For the full list of specifications see page 53  
For the dimension drawing see page 43

### Related Products



ML-Series Remote Battery Switches page 43



MRBF Terminal Fuse Blocks page 68



Remote Control Switch 360 Panels page 94



Paralleling Link Bus page 43 (see table)



LEDs page 153



Stud Mount Insulators page 108



7622



Remote Control Contura Switch included in retail package



7620



Deutsch DTM Cable End now offered for both retail and bulk units. Other connector plugs are available for high volume OEM applications.



# Solenoid and Remote Battery Switch Specification Table



Part #	9012	7765	7701	7703	7718	7719	7700	7702	7713	7717
Page #	39		40				43			
Product Type	Solenoid Switches						Remote Battery Switches (RBS)			
Function	Provides high-amp switching						Provides high-amp switching with manual override			
Product	L-Series Solenoid		ML-Series Solenoid				ML-Series RBS			
Manual Control	--		--				Yes			
Nominal Voltage	12V/24V DC		12V DC	24V DC	12V DC	24V DC	12V DC	24V DC	12V DC	24V DC
Operating Voltage (contacts)	0-800V	0-320V	0-64V		9-16V	18-32V	0-64V		9-16V	18-32V
Control Voltage	9-36V		9-16V	18-32V	9-16V	18-32V	9-16V	18-32V	9-16V	18-32V
Cranking Rating (30 sec.)	1,000A DC	600A DC	1,450A DC				1,450A DC			
Intermittent Rating (5 min.)	275A DC	225A DC	700A DC				700A DC			
Continuous Rating	250A DC	150A DC	500A DC				500A DC			
Operating Current - continuous @ 25°C nominal V DC	0.13A @ 12V DC 0.07A @ 24V DC		0mA		< 13mA		0mA		< 13mA	
Operating Current - when changing state	3.6A DC	3.8A DC	< 7.0A DC	< 4.0A DC	< 7.0A DC	< 4.0A DC	< 7.0A DC	< 4.0A DC	< 7.0A DC	< 4.0A DC
Switching Cycles	1,000,000	200,000	100,000				100,000			
Live Switching Cycles	40,000 @ 24V, 250A 1,500 @ 450V, 250A 1,000 @ 800V, 250A	80,000 @ 28V, 150A 10,000 @ 320V, 150A	10,000 @ 12V, 300A 10,000 @ 24V, 150A 2000 @ 48V, 100A	10,000 @ 12V, 300A	10,000 @ 24V, 150A	10,000 @ 24V, 150A	10,000 @ 12V, 300A 10,000 @ 24V, 150A 2000 @ 48V, 100A	10,000 @ 12V, 300A	10,000 @ 24V, 150A	10,000 @ 24V, 150A
Control Signal	Continuous		Momentary		Continuous		Momentary		Continuous	
Coil Function	Normally Open		Magnetic Latching Bi-Stable		Magnetic Latching Auto-Releasing		Magnetic Latching Bi-Stable		Magnetic Latching Auto-Releasing	
Remote Control Switch Included	--		2145 SPDT (ON)-OFF-(ON)		2155 SPDT ON-ON		2145 SPDT (ON)-OFF-(ON)		2155 SPDT ON-ON	
Control Circuit Connection	Tinned Wire		Tinned Wire or Deutsch Connector				Tinned Wire or Deutsch Connector			
Mounting Hardware	#10 or M5		#10 or M5				#10 or M5			
Terminal Stud Size	M8 (accepts 5/16" terminals)		3/8"-16 (M10)				3/8"-16 (M10)			
Terminal Stud Length	5/8" (16 mm)		7/8" (22 mm)				7/8" (22 mm)			
Maximum Terminal Stud Torque	90 in-lb (10.0 Nm)		140 in-lb (15.5 Nm)				140 in-lb (15.5 Nm)			
Cable Size to Meet Ratings	1/0 AWG (50 mm <sup>2</sup> )	2 AWG (35 mm <sup>2</sup> )	4/0 AWG (120 mm <sup>2</sup> ) × 2				4/0 AWG (120 mm <sup>2</sup> ) × 2			
Terminal Ring Diameter Clearance	not rated		1.12" (28.4 mm)				1.12" (28.4 mm)			
Width	3.17" (80.5 mm)	3.18" (80.8 mm)	3.75" (95.2 mm)				3.75" (95.2 mm)			
Height	2.21" (56.1 mm)	2.29" (58.2 mm)	5.47" (138.9 mm)				5.47" (138.9 mm)			
Depth	2.86" (72.6 mm)	2.90" (73.7 mm)	2.03" (51.6 mm)				2.03" (51.6 mm)			
Ignition Protected	ISO 8846 SAE J1171	ISO 8846 SAE J1171	ISO 8846, SAE J1171				ISO 8846, SAE J1171			
Ingress Protected (see inside back cover)	IP67		IP66				IP66			

## Non-Critical Load Disconnect and Automatic Charging Relay Specification Table



7635	7615	7601	7610	7611	7620	7622	7621	7623
40	41	46	47	50	51			
Non-critical Load Disconnects		Automatic Charging Relays (ACR)						
Disconnects non-critical loads after a set voltage		Disconnects non-critical loads after a set time		Allows charging of multiple batteries from a single charge source				
m-LVD	ATD	m-ACR	SI-ACR	BatteryLink ACR	ML-Series ACR			
--	--	--		--	Yes	--	Yes	
12V DC		12V/24V DC			12V DC		24V DC	
--					1,450A DC			
115A DC	210A DC	115A DC	210A DC		700A DC			
65A DC	120A DC	65A DC	120A DC		500A DC			
4mA open 95mA connected	15mA open 175mA connected	15mA open 90mA combined	15mA open 175mA combined		< 13mA			
--					< 7.0A DC		< 4.0A DC	
--					100,000			
--					--			
--					--			
Normally Open					Magnetic Latching Bi-Stable			
SPDT (ON)-OFF-(ON)	--				2146 SPDT ON-OFF-ON			
1/4" Quick Connect					Tinned Wire or Deutsch Connector			
#10 or M5	#8 or M4	#10 or M5	#8 or M4		#10 or M5			
1/4"-20 (M6)	3/8"-16 (M10)	1/4"-20 (M6)	3/8"-16 (M10)		3/8"-16 (M10)			
7/16" (11 mm)	7/8" (22 mm)	7/16" (11 mm)	7/8" (22 mm)		7/8" (22 mm)			
60 in-lb (6.8 Nm)	140 in-lb (15.8 Nm)	60 in-lb (6.8 Nm)	140 in-lb (15.8 Nm)		140 in-lb (15.8 Nm)			
6 AWG (16 mm <sup>2</sup> )	1/0 AWG (50 mm <sup>2</sup> )	6 AWG (16 mm <sup>2</sup> )	1/0 AWG (50 mm <sup>2</sup> )		4/0 AWG (120 mm <sup>2</sup> ) × 2			
0.80" (20.3 mm)	1.05" (26.7 mm)	0.80" (20.3 mm)	1.05" (26.7 mm)		1.12" (28.4 mm)			
2.85" (72.3 mm)	3.89" (98.7 mm)	2.85" (72.3 mm)	3.89" (98.7 mm)		3.75" (95.3 mm)			
2.85" (72.3 mm)	3.50" (89.0 mm)	2.85" (72.3 mm)	3.50" (89.0 mm)		5.47" (138.9 mm)			
2.57" (65.2 mm)	1.98" (50.3 mm)	2.57" (65.2 mm)	1.98" (50.3 mm)		2.03" (51.6 mm)			
ISO 8846 SAE J1171	ISO 8846 SAE J1171	ISO 8846 SAE J1171	ISO 8846, UL1500 SAE J1171		ISO 8846, SAE J1171			
IP67	IP66	IP67			IP66			



# CIRCUIT PROTECTION & SWITCHES

## Fuses

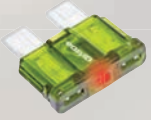

56

For .25A to 750A circuit protection.

## Fuses Holders



60

In-line fuse holders are compact and hold a single low-amperage fuse.

## Fuse Blocks



61

Fuse blocks mount to a solid surface and may hold a single fuse or multiple fuses.

## ST-Blade Water-Resistant Fuse Block



62

Provides water-resistant circuit protection for ATO/ATC fuses & circuit breakers in a compact footprint.

## Circuit Breaker Blocks



74

Innovative block designed for Push-Button CLB Circuit Breakers with quick connect terminals.





# CIRCUIT PROTECTION & SWITCHES

## ATO/ATC-Style Circuit Breakers



77

Use a manually resettable circuit breaker instead of an ATO or ATC fuse.

## Thermal Circuit Breakers



78

Circuit breakers offer the ability to reset instead of replace the device after a fault.

## UL-489 Circuit Breakers



81

Expanded line of circuit breakers that meet CFR 46 / Coast Guard requirements.

## Surface Mount Systems



88

Panel enclosure for ELCI Main circuit breakers and other large frame devices.

## Switches



92

Switching options for different apertures and configurations.



## Best practices recommend every wire, except the engine starting circuit, have circuit protection.

When excessive current flows in an electrical circuit, wire insulation can melt and possibly start a fire. Circuit breakers and fuses protect the wire in electrical circuits. Blue Sea Systems' selection of circuit breakers, fuses, fuse holders, and fuse blocks offer a range of choices for main and branch circuit protection. To help in the selection process, Blue Sea Systems developed the Circuit Wizard to determine the correct size wire and fuse or circuit breaker for the application. Go to [circuitwizard.blueseasystems.com](http://circuitwizard.blueseasystems.com) to download the app.

## TECH TIP

### Color Coding

The circuit protection color coded packaging matches fuses with the corresponding fuse holder or fuse block for easier component selection. Look for color rectangles on the packaging of each fuse holder and fuse block, and match the color with the fuse packaging to find the correct fuse type. Some fuse blocks require two different fuse types.



## CIRCUIT WIZARD

### Determine Your Circuit Requirements

Use the Blue Sea Systems Circuit Wizard to select the correct wire size, circuit breaker, or fuse and fuse holder. [www.circuitwizard.blueseas.com](http://www.circuitwizard.blueseas.com)



## GMA® and AGA® Fuses

Fast-acting glass fuses

- Visible indication of blown condition
- Used for 12V/24V DC applications



GMA®



AGA®

Blow Time Delay See [blueseas.com](http://blueseas.com)

Part #	Fuse Type	Amps	DC Volts	AC Volts	Retail Pack
5280	GMA	1A	24V DC	250V AC	3
5281	GMA	2A	24V DC	250V AC	3
5282	GMA	3A	24V DC	250V AC	3
5283	GMA	5A	24V DC	125V AC	3
5284	GMA	7A	24V DC	125V AC	3
5285	GMA	10A	24V DC	125V AC	3
5275	AGA	20A	32V DC	--	5

Protect your boat with the correct size wire and fuse, see p. 159

## AGC® and MDL® Fuses

AGC – Fast-acting glass fuses

MDL – Slow-blow glass fuses

- Visible indication of blown condition



AGC®



MDL®

Voltage Max. Operating 32V DC / See table for AC

Blow Time Delay See [blueseas.com](http://blueseas.com)

### AGC Fuses

Part #	Amps	Volts	Retail Pack
5202	.5A	250V AC	5
5204	1A	250V AC	5
5204100	1A	250V AC	25
5205	1.5A	250V AC	5
5206	2A	250V AC	5
5206100	2A	250V AC	25
5207	2.5A	250V AC	5
5208	3A	250V AC	5
5208100	3A	250V AC	25
5209	4A	250V AC	5
5210	5A	250V AC	5
5210100	5A	250V AC	25
5211	6A	250V AC	5
5212	7A	250V AC	5
5213	7.5A	250V AC	5
5213100	7.5A	250V AC	25
5215	10A	250V AC	5
5215100	10A	250V AC	25
5217	15A	--	5
5217100	15A	--	25
5218	20A	--	5
5218100	20A	--	25
5219	25A	--	5
5219100	25A	--	25
5220	30A	--	5
5220100	30A	--	25
5288	1A, 3A, 5A, 10A, 15A		5
5289	4 each 1A, 2A, 3A, 5A, 7.5A, 10A, 15A, 20A, 25A, 30A		40

### MDL Fuses

Part #	Amps	Volts	Retail Pack
5226	3A	250V AC	2
5227	5A	250V AC	2
5228	6.25A	250V AC	2
5229	7.5A	250V AC	2
5230	10A	--	2
5231	15A	--	2
5232	20A	--	2
5233	25A	--	2
5234	30A	--	2



5289 Includes a Heavy Duty In-Line Fuse Holder 5063 p. 60

### Related Products



AGC or MDL In-Line fuse holders page 60



ST-Glass Fuse Blocks page 61

Protect your boat with the correct size wire and fuse, see p. 159



## ATM® Fuses

### Mini blade-type fuse

- Color-coded for easy identification
- Visible indication of blown condition
- Tin-plated connector blades for corrosion resistance



Interrupting Capacity	1,000A
Voltage Max. Operating	32V DC
Blow Time Delay	See <a href="http://blusea.com">blusea.com</a>

Part #	Amps	Retail Pack
5261	2A	2
5262	3A	2
5263	4A	2
5270	5A	2
5264	7.5A	2
5271	10A	2
5272	15A	2
5273	20A	2
5265	25A	2
5274	30A	2
5286	5A, 10A, 15A, 20A, 30A	5

Protect your boat with the correct size wire and fuse, see p. 159

## ATO® or ATC® Fuses

### Fast-acting blade fuse

- Color-coded for easy identification
- Visible indication of blown condition
- Tin-plated connector blades for corrosion resistance



Interrupting Capacity	1,000A
Voltage Max. Operating	32V DC
Blow Time Delay	See <a href="http://blusea.com">blusea.com</a>

Part #	Amps	Retail Pack	Part #	Amps	Retail Pack
5235	1A	2	5235100	1A	25
5236	2A	2	5236100	2A	25
5237	3A	2	5237100	3A	25
5238	4A	2	5239100	5A	25
5239	5A	2	5240100	7.5A	25
5240	7.5A	2	5241100	10A	25
5241	10A	2	5242100	15A	25
5242	15A	2	5243100	20A	25
5243	20A	2	5244100	25A	25
5244	25A	2	5245100	30A	25
5245	30A	2			
5246	40A	2			
5287	5A, 10A, 15A, 20A, 25A, 30A	6			

Protect your boat with the correct size wire and fuse, see p. 159

### Related Products



Fuse Holders page 60

ST-Blade Fuse Blocks page 62-67

SafetyHub Fuse Blocks page 71

WeatherDeck Waterproof Fuse Panels page 115

## easyID™ ATC® Fuses

Fast-acting easyID™ illuminated blade fuses use Light Emitting Diode (LED) technology to show when a fuse has blown

- Color-coded for easy identification
- Visible indication of blown condition
- Tin-plated connector blades for corrosion resistance



Interrupting Capacity	1,000A
Voltage Max. Operating	32V DC
Blow Time Delay	See <a href="http://blusea.com">blusea.com</a>

Part #	Amps	Retail Pack
5291	3A	2
5292	5A	2
5293	7.5A	2
5294	10A	2
5295	15A	2
5296	20A	2
5297	25A	2
5298	30A	2
5299	40A	2
5290	3x 3A, 3x 5A, 3x 7.5A, 3x 10A, 6x 15A, 3x 20A, 3x 25A, 3x 30A, 3x 40A	30



5290

Protect your boat with the correct size wire and fuse, see p. 159

## MAXI® Fuses

Provides economical branch circuit protection

- Color-coded for easy identification
- Silver-plated connector blades for corrosion resistance
- Visible indication of blown condition



Interrupting Capacity	1,000A
Voltage Max. Operating	32V DC
Blow Time Delay	See <a href="http://blusea.com">blusea.com</a>

Part #	Amps	Retail Pack
5138	30A	1
5139	40A	1
5140	50A	1
5141	60A	1
5142	70A	1
5143	80A	1

Protect your boat with the correct size wire and fuse, see p. 159

### Related Products

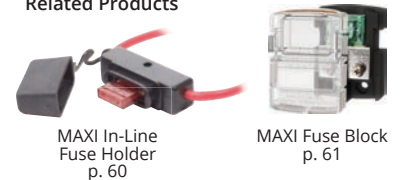

MAXI In-Line Fuse Holder p. 60

MAXI Fuse Block p. 61

## AMI® or MIDI® Fuses

Compact fuse for main or branch 30A to 200A circuit protection

- Color-coded for easy identification
- Visible indication of blown condition
- Tin-plated connector blades for corrosion resistance



Interrupting Capacity	5,000A @ 16V DC 2,000A @ 32V DC
Voltage Max. Operating	32V DC
Regulatory	Meets SAE J1171 external ignition protection requirements when used with Blue Sea Systems' fuse blocks, IP66 – protected against powerful water jets (see inside back cover)

**IGNITION PROTECTED**

Part #	Amps	Color	Retail Pack
5250	30A	Orange	2
5251	40A	Green	2
5252	50A	Red	2
5253	60A	Yellow	2
5254	70A	Brown	2
5255	80A	White	2
5256	100A	Blue	2
5257	125A	Pink	2
5258	150A	Lt Blue	2
5259	175A	Tan	2
5260	200A	Purple	2

### Related Products



Safety Fuse Block 7720 p. 70



SafetyHub Fuse Blocks p. 71

## MEGA® or AMG® Fuses

Economical fuse for 100A to 300A circuit protection

Interrupting Capacity	1,000A
Voltage Max. Operating	32V DC
Trip Time Delay	See <a href="http://blueseas.com">blueseas.com</a>
Regulatory	Meets SAE J1171 external ignition protection requirements when used with Blue Sea Systems' Safety Fuse Block 7721 IP66 – protected against powerful water jets (see inside back cover)



**IGNITION PROTECTED**

Part #	Amps	Retail Pack
5101	100A	1
5102	125A	1
5103	150A	1
5104	175A	1
5105	200A	1
5107	250A	1
5108	300A	1

Protect your boat with the correct size wire and fuse, see p. 159

### Related Products



MEGA or AMG Fuse Block page 68



Safety Fuse Block 7721 page 70

## MRBF Fuses

MRBF—Marine Rated Battery Fuse

Space-saving ignition protected fuse for 30A to 300A loads. Must use with MRBF Fuse Blocks (p. 68)

- Color-coded for easy identification
- Visible indication of blown condition



Interrupting Capacity	10,000A @ 14V DC 5,000A @ 32V DC 2,000A @ 58V DC
Voltage Max. Operating	58V DC
Fuse Hole Opening	M8 (5/16")
Trip Time Delay	See <a href="http://blueseas.com">blueseas.com</a>
Regulatory	Meets SAE J1171 external ignition protection requirements, IP66 – protected against powerful water jets (see inside back cover)

**IGNITION PROTECTED**

**ABYC E-11.10.1.1.1.** Overcurrent Protection Device Location - Ungrounded conductors shall be provided with overcurrent protection within a distance of seven inches (175mm) of the point at which the conductor is connected to the source of power measured along the conductor

Part #	Amps	Color	Retail Pack
5175	30A	LT Green	1
5176	40A	LT Blue	1
5177	50A	Red	1
5178	60A	Gold	1
5180	75A	Brown	1
5181	80A	Lime	1
5182	90A	Purple	1
5183	100A	Yellow	1
5184	125A	Green	1
5185	150A	Orange	1
5186	175A	White	1
5187	200A	Blue	1
5189	250A	Pink	1
5190	300A	Gray	1

Protect your boat with the correct size wire and fuse, see p. 159

### Related Products



MRBF Fuse Blocks page 68

## Class-T Fuses

High interrupt capacity for large battery banks including Lithium-Ion and TPPL batteries



- Extremely fast short-circuit response
- Recommended by most inverter manufacturers

Interrupting Capacity	20,000A @ 125V DC
Voltage Max. Operating	125V DC
Trip Time Delay	See <a href="http://blueseas.com">blueseas.com</a>
Regulatory	UL listed to standard 248-15

Part #	Amps	Retail Pack
5112	110A	1
5113	125A	1
5114	150A	1
5115	175A	1
5116	200A	1
5117	225A	1
5118	250A	1
5119	300A	1
5120	350A	1
5121	400A	1

Protect your boat with the correct size wire and fuse, see p. 159

### Related Products



Class-T Fuse Blocks page 69

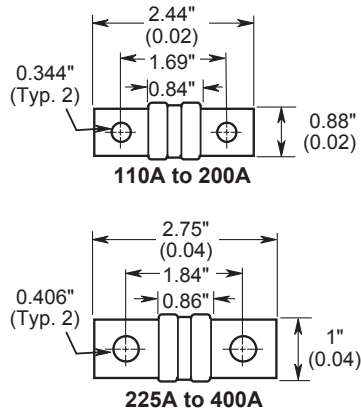

## ANL Fuses

For 35A to 750A circuit protection



- Silver-plated connector blades for corrosion resistance
- Visible indication of blown condition

Interrupting Capacity	6,000A @ 32V DC
Voltage Max. Operating	32V DC
Trip Time Delay	See <a href="http://blueseas.com">blueseas.com</a>
Regulatory	35-500A ONLY – Meets SAE J1171 external ignition protection requirements

### IGNITION PROTECTED

Part #	Amps	Retail Pack	Part #	Amps	Retail Pack
5164	35A	1	5129	200A	1
5165	40A	1	5131	250A	1
5122	50A	1	5133	300A	1
5123	60A	1	5135	350A	1
5124	80A	1	5136	400A	1
5125	100A	1	5137	500A	1
5126	130A	1	Not Ignition Protected		
5127	150A	1	5161	600A	1
5128	175A	1	5163	750A	1

Protect your boat with the correct size wire and fuse, see p. 159

### Related Products



ANL Fuse Blocks page 69

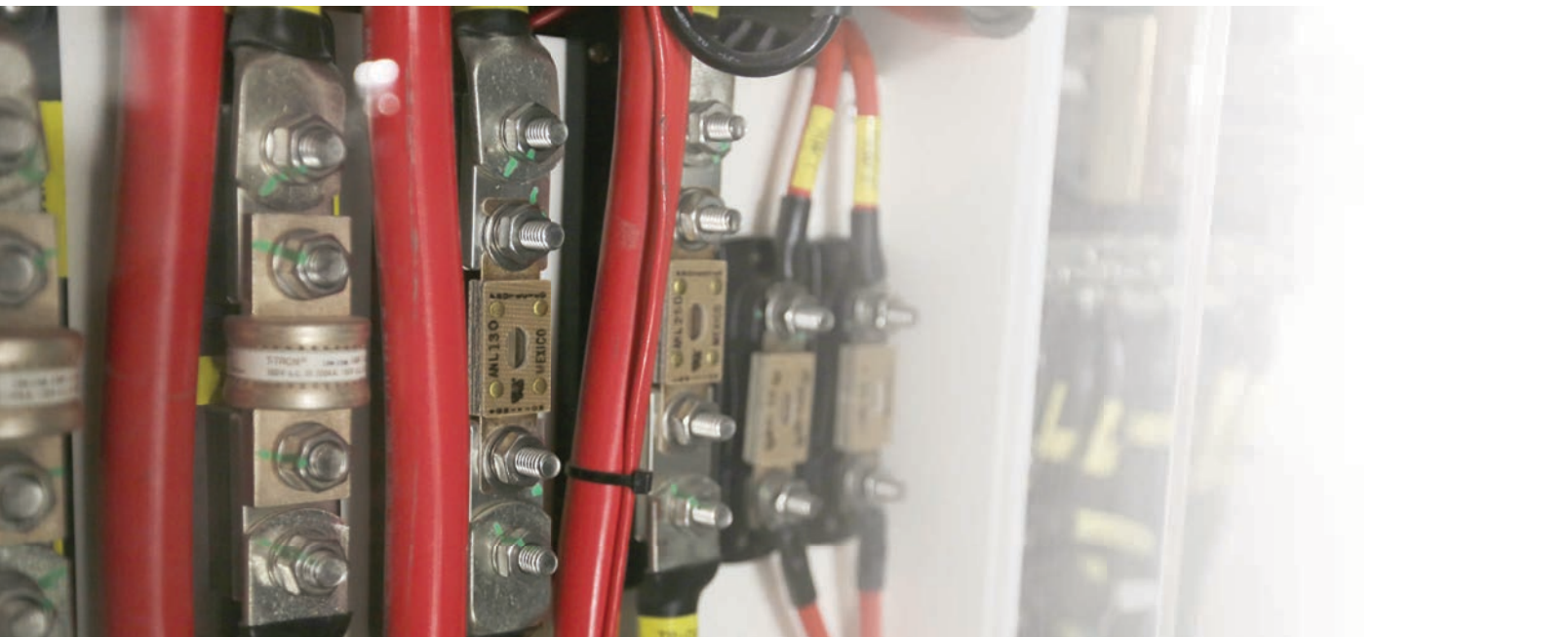



### AGC® or MDL® In-Line Fuse Holders

#### Crimpable In-Line Fuse Holder

- Accepts 12-16 AWG wire
- 30A Max. fuse amperage
- Fuse sold separately (p. 56)



Part #	Description
5060	AGC or MDL In-Line Fuse Holder

#### Waterproof In-Line Fuse Holder

- Accepts 12-18 AWG wire
- 30A Max. fuse amperage
- Fuse sold separately (p. 56)



Part #	Description
5061	Waterproof In-Line Fuse Holder

#### Waterproof In-Line Fuse Holder

- Accepts 12-16 AWG wire
- 20A Max. fuse amperage
- Fuse sold separately (p. 56)



Part #	Description
5062	Waterproof In-Line Fuse Holder

#### Heavy Duty In-Line Fuse Holder

- Accepts 12-18 AWG wire
- 30A Max. fuse amperage
- Fuse sold separately (p. 56)



Part #	Description
5063	Heavy Duty In-Line Fuse Holder

#### Water-Resistant Fuse Holder

##### Panel Mount

- Rated IP66 on front – protected against powerful water jets
- 20A Max. fuse amperage
- 0.50" (12.70 mm) mounting hole
- Fuse sold separately (p. 56)



5022 Replacement cap for 5021

Part #	Description
5021	Water-Resistant Panel Mount Fuse Holder
5022	Replacement Cap

#### Related Products

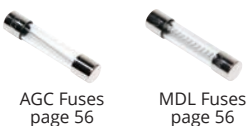

AGC Fuses page 56

MDL Fuses page 56

### ATO® or ATC® In-Line Fuse Holders

#### In-Line Fuse Holder

- Supplied with 12 AWG pigtails
- 30A Max. fuse amperage
- Fuse sold separately (p. 57)



5064

#### Waterproof In-Line Fuse Holder

- Supplied with 12 AWG pigtails
- 30A Max. fuse amperage
- Fuse sold separately (p. 57)



5065

Part #	Description
5064	ATO or ATC In-Line Fuse Holder
5065	ATO or ATC Waterproof In-Line Fuse Holder

#### Related Products



ATO or ATC Fuses p. 57



easyID ATC Fuses p. 57

### MAXI® In-Line Fuse Holder

#### In-line fuse holder for MAXI Fuses

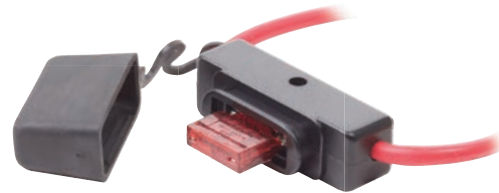

- Supplied with 5 inch #6 lead wires and two adhesive lined sealing shrink wrap tubes for sealed terminations
- Firewall mounting hole permits two or more holders to be mounted together
- Protective cover with retaining strap
- Fuse sold separately (p. 57)

Voltage Max. Operating	32V DC
Amperage Max. Continuous	8A
Fuse Max. Amperage	60A
Mounting Hole	1/4", m6, or #12 Screws

Part #	Description
5068	MAXI In-Line Fuse Block

#### Related Products



MAXI Fuses page 57

## MAXI® Fuse Block

Ignition protected fuse block allows for installation in a gasoline engine compartment

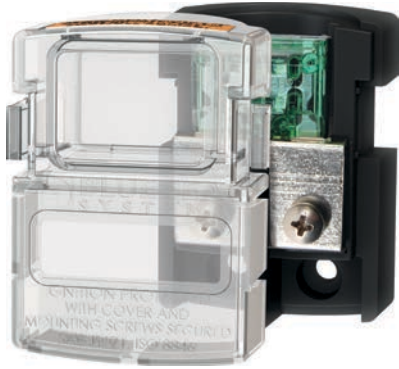

NOTE: 5006100 replaces 5006

- Snap-on terminal cover insulates all conductive parts, satisfying ABYC/USCG requirements
- Cover breakouts allow wires from sides or bottom
- Terminal screws compress fuse blades within blocks for low resistance connections
- Label recess accepts large format label (p. 154)
- Fuses sold separately (p. 57)

Voltage Max. Operating	32V DC
Amperage Max. Operating	80A
Wire Size	14-4 AWG
MAXI® Fuses available	30A-80A
Screw Terminal Torque	25 in-lb
Mounting	#10 Screws
Regulatory	CE & UKCA certified, meets ISO 8846 and SAE J1171 external ignition protection requirements when cover is securely latched and all mounting screws are installed.

**IGNITION PROTECTED**

Part #	Description
5006100	MAXI Fuse Block

For the full list of specifications see page 73

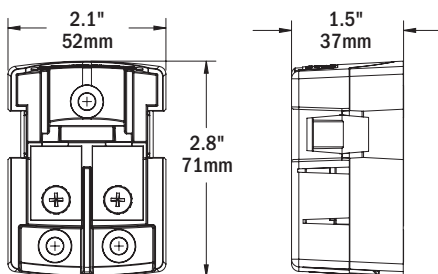

### Related Products



MAXI Fuses page 57

## ST-Glass Fuse Blocks

Innovative design allows for labeling, spare fuse storage, and easy fuse removal



5015

- Can be used for 24-hour circuits
- Screw terminals for securing wires
- Integrated fuse ejector levers
- Clear insulating cover satisfies ABYC/USCG insulation requirements, accepts Large Format Labels (p. 154), and provides storage for spare fuses
- Tin-plated phosphor bronze fuse clips are encapsulated and cannot be sprung
- One-piece stainless flange nuts ensure safe and secure connections
- Fuses sold separately (p. 56)

Voltage Max. Operating	32V DC
Amperage Max. Operating	30A per circuit
Amperage Max. Operating	100A per block
Fuse Type	AGC or MDL Fuses
Screw Terminal	#8-32 with captive star lock washer
Mounting	#8 Screw (M4)

Part #	Circuits	Tin-plated copper negative bus
5015	6	#10-32 stud
5018	6	--

For the full list of specifications see page 73

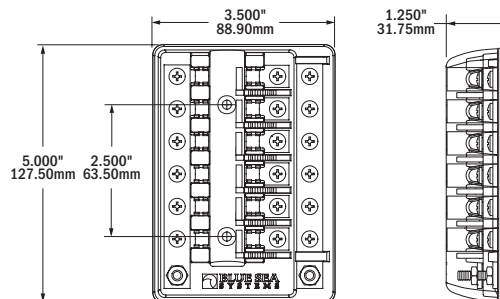

### Related Products



AGC Fuses page 56

MDL Fuses page 56

## ST-Blade Water-Resistant Fuse Block

Provides water-resistant circuit protection for ATO/ATC fuses & circuit breakers in a compact footprint

- Water-resistant IP66 design
- Accepts standard ring or fork type terminals to allow for simple wiring with standard tools
- Accepts a wide range of wire sizes
- Integral plugs maintain water-resistant rating if less than four loads are required
- Accepts ATO, ATC and EasyID fast-acting blade fuses (p. 57)
- Accepts ATO/ATC-Style Low Profile Circuit Breakers (p. 77)
- Nests with ST-Blade Water-Resistant Fuse Block (5056 or 5056100) and Water-Resistant 100A Bus Bar (2356 or 2356100)
- Tin-plated copper busses and fuse clips
- Includes four write-on circuit labels
- Small format standard and custom labels available
- Spare fuse and fastener storage in cover
- Fuses (p. 57) and circuit breakers (p. 77) sold separately

Voltage Max. Operating	32V DC
Amperage Max. Operating	80A per block / 25A per circuit
Fuse Type	ATO or ATC fuses & circuit breakers
Input Wire Size	(1) 8 AWG to 4 AWG
Load Wire Size	(4) 16 AWG to 10 AWG
Bus Material	Tin-Plated Copper C11000
Mounting Thru-hole	Accepts 1/4" (6mm) screws
Screw Terminal	4x #8-32 Screws with captive star lock washer
Stud Terminal	1x #10-32
Regulatory	CE & UKCA certified. For an ABYC/USCG compliant design use (5056100) CE marked, IP66 - protected against powerful water jets (see inside back cover)

Part #	Description	Cover
5056	ST-Blade Water-Resistant Fuse Block	Screw Cover
5056100	ST-Blade Water-Resistant Fuse Block	Manual Cover

For the full list of specifications see page 73

For the mounting diagram see page 100

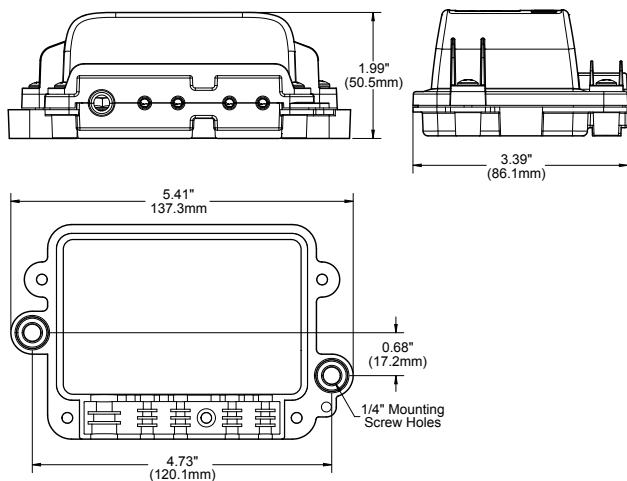

### Related Products



Water-Resistant BusBar  
page 100



ATO, ATC & EasyID Fuses  
page 57



ATO/ATC  
Circuit Breakers  
page 77



5056100



5056

## TECH TIP

### ST-Blade Water-Resistant Fuse Block

The difference between our new ST-Blade Water-Resistant Fuse Blocks and Busbars are how the fuses and terminations are accessed: Part numbers 5056 / 2356 utilize #8 screws to secure the cover to the rest of the housing, requiring a screwdriver - or tool - for access, and do not meet ABYC requirements for panel boards. Part numbers 5056100 / 2356100 utilize yellow wing-screws that can be manipulated by hand, and comply to the following:

#### ABYC E-11.4.23 states:

**Panelboard** - an assembly of devices for the purpose of controlling and/or distributing power on a boat. It may include devices such as circuit breakers, fuses, switches, instruments, and indicators.

#### ABYC E-11.4.27 states:

**Readily Accessible** - capable of being reached quickly and safely for effective use under emergency conditions without the use of tools.

#### ABYC E-11.9.1.2 states:

**A panelboard shall be installed in a readily accessible location and shall be weatherproof or be protected from weather and water splash.**

The ST-Blade Water-Resistant Fuse Blocks and Busbars are rated IP66 and withstand water from heavy seas or projected in powerful jets, allowing for flexible installations anywhere on boats or vehicles.



# ST-Blade Battery Terminal Mount Fuse Block



Easily add 4 fused circuits to the terminal of a battery to provide power to new accessories

- Mounts on the battery terminal stud
- Screw terminals for securing wires
- Nylon insulated ring terminals included for each screw terminal
- Insulating cover meets ABYC/USCG insulation requirements
- Ignition protected - for use in a gasoline engine compartment
- Includes four 16-14 AWG and four 12-10 AWG Nylon insulated ring terminals
- Includes four write-on circuit labels
- Small format standard and custom labels available
- Fuses sold separately (p. 57)

Voltage Max. Operating	32V DC
Amperage Max. Operating	100A per block / 30A per circuit
Fuse Type	ATO or ATC Fuses
Bus Material	Tin-Plated Copper C11000
Mounting Thru-hole	Clearance for 3/8" [M10] stud
Screw Terminal	#8-32 Screws with captive star lock washer
Regulatory	CE & UKCA certified, meets ISO 8846 and SAE J1171 external ignition protection requirements

**IGNITION PROTECTED**

Part #	Description
5023	ST-Blade Battery Terminal Mount Fuse Block protection
5024	ST-Blade Battery Terminal Mount Fuse Block Kit

For the full list of specifications see page 73

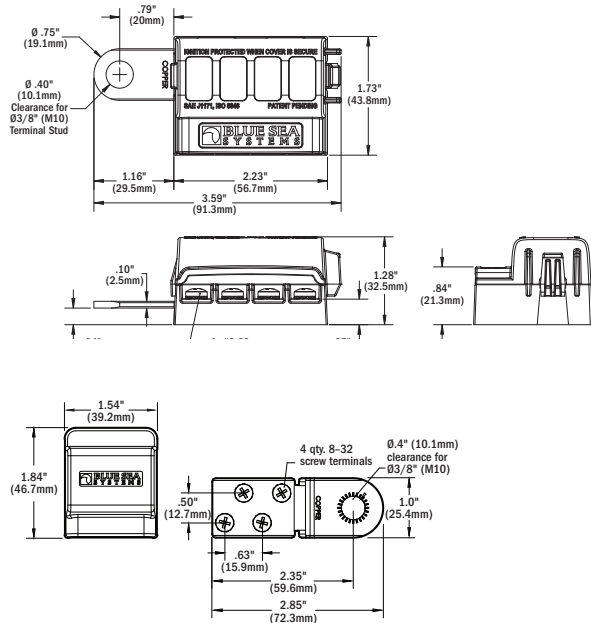

### Related Products



ATO, ATC & EasyID Fuses page 57



2340 BusBars page 105



5023



Nylon insulated ring terminals



5024

- Includes a 4-circuit negative busbar see page 105

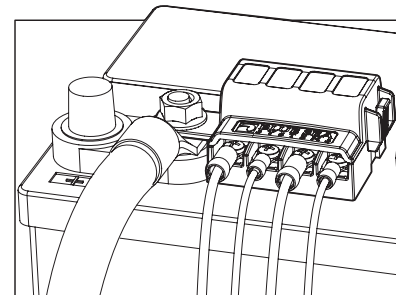

5023 Installed

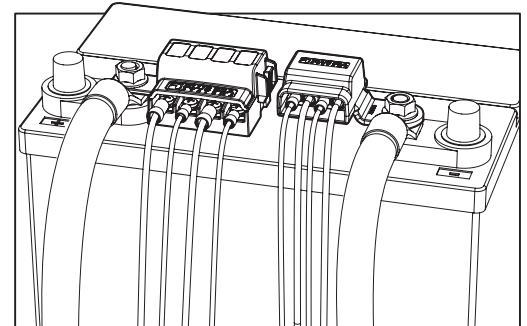

5024 Installed

# ST-Blade Fuse Blocks

## Independent Source

Consolidates branch circuits and eliminates in-line fuses

- Independent source fuse block
- Can be used for 24-hour circuits and switched circuit in same block
- Screw terminals for securing wires accept ring terminals
- Clear insulating cover with label recesses and storage for one fuse, satisfies ABYC/USCG insulation requirements
- Easy to open, push button latch for easy access to fuses
- Tin-plated copper buses and fuse clips
- Fuse Block with cover includes 20 write-on circuit labels and two Terminal Block Jumpers Part # 9217 (p. 103)
- Small format standard and custom labels available
- Fuses sold separately (p. 57)

Voltage Max. Operating	32V DC
Amperage Max. Operating	30A per circuit
Amperage Max. Operating	40A per jumped circuit group
Fuse Type	ATO or ATC Fuses
Screw Terminal	#8-32 Screws with captive star lock washer
Mounting	#8 Screw (M4)

Part #	Circuits	Cover
5035	6	Yes
5037	6	-

For the full list of specifications see page 73



5035

### Application Diagram

Two 24-Hour Circuits and Four Switched Circuits

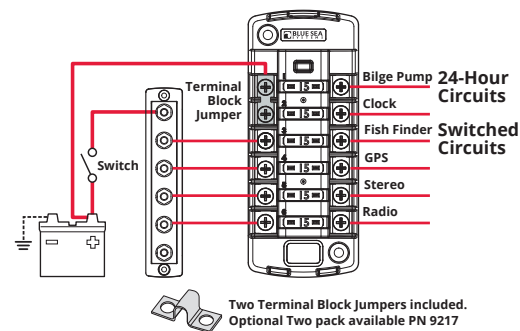

5037

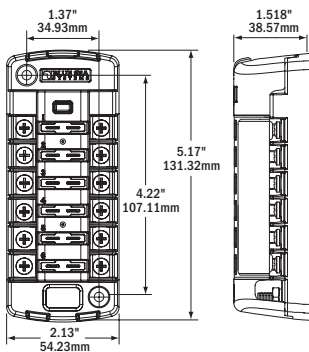

### Related Products



ATO or ATC Fuses page 57



easyID ATC Fuses page 57



Terminal Block Jumpers page 103

## TECH TIP

### Fuse Sizing Best Practices - 80% Rule

It is a common misconception that a fuse should be rated for the same amperage as the circuit. Fuses include a metal component designed to heat up when current runs through them. The more current, the hotter the metal gets. When too much current runs through the fuse, the metal heats up enough to separate, breaking the circuit. This means that rating a fuse at the same amperage as the circuit will produce the maximum heat in the fuse without actually breaking the circuit. For this reason the National Electrical Code recommends limiting the amount of current in a circuit to 80% of the fuse rating in that circuit. In other words a 32A fuse would be appropriate for a circuit with a maximum of 32A continuous. This is why you will see many fuse blocks with maximum continuous amperage ratings around 80% of the largest available fuse.

# ST-Blade Split Bus Fuse Block

## Common and/or Independent Source

For use when a mix of switched and 24-hour circuits are desired in the same block

- Common and/or independent source fuse block
- Provides two isolated groups of six ATO/ATC circuits
- For use with either two isolated batteries or with a single battery providing a mix of 24-hour and switched circuits
- Clear insulating cover satisfies ABYC/USCG insulation requirements and provides storage for two spare fuses
- Accepts ring terminals
- Easy to open, push button latch provides easy access to fuses
- Tin-plated copper buses and fuse clips
- Includes 20 write-on circuit labels
- Fuses sold separately (p. 57)

Voltage Max. Operating	32V DC
Amperage Max. Operating	30A per circuit, 100A total (not to exceed 80A per load group)
Fuse Type	ATO or ATC Fuses
Screw Terminal	#8-32 Screws with captive star lock washer
Mounting	#8 Screw (M4)
Recommended Wire Size	Positive Feed: 4-6 AWG (25-16 mm <sup>2</sup> ) Branch Circuits: 10-16 AWG (6-15 mm <sup>2</sup> )
Recommended Torque	#10 Stud: 24 in-lb (2.71 N-m) #8 Screw: 18 in-lb (2.03 N-m)

Part #	Circuits	Cover	Negative Bus	Positive Bus
5032	12	Yes	#10-32 stud	#10-32 stud

For the full list of specifications see page 73

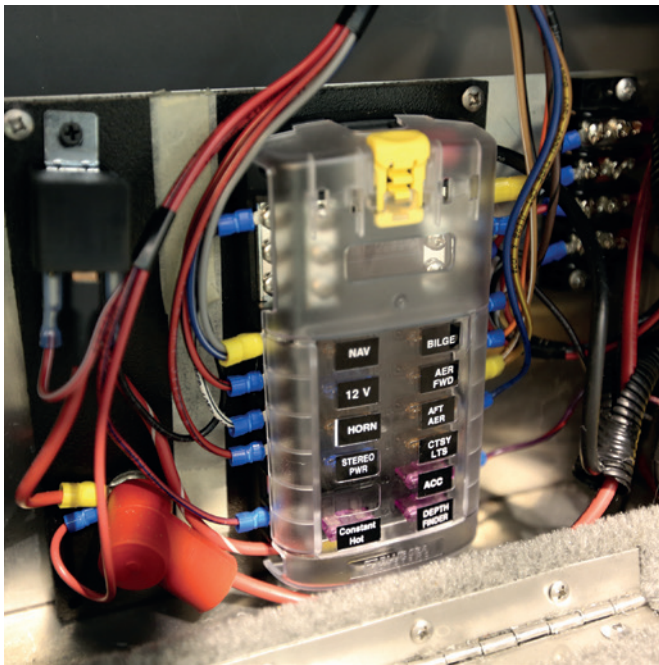

### Application Diagram

Six 24-Hour Circuits and Six Switched Circuits

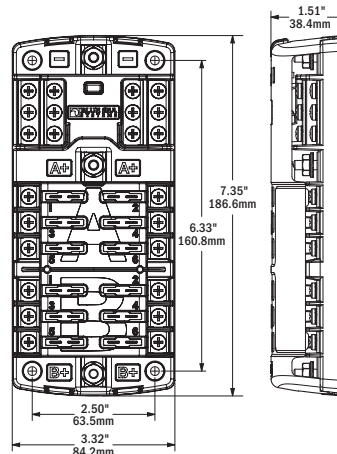
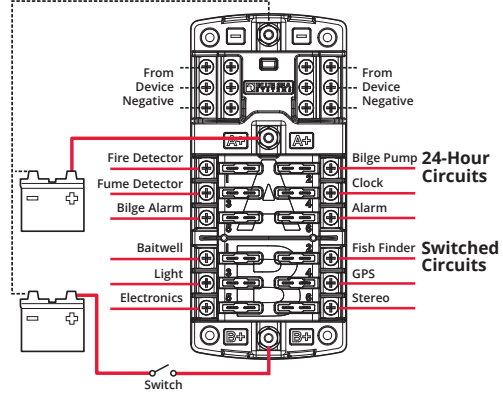

### Related Products





# ST-Blade Common Source Fuse Blocks

## Common Source

Consolidates branch circuits and in-line fuses

- Common source fuse block
- Screw terminals for securing wires accept ring terminals
- One-piece stainless flange nuts ensure safe and secure connections
- Clear insulating cover with label recesses and storage for two fuses, satisfies ABYC/USCG insulation requirements
- Easy to open, push button latch for easy access to fuses
- Tin-plated copper buses and fuse clips
- Fuse blocks with covers include 20 write-on circuit labels small format standard and custom labels available
- Fuses sold separately (p. 57)

Voltage Max. Operating	32V DC
Amperage Max. Operating	30A per circuit 100A per block
Fuse Type	ATO or ATC Fuses
Screw Terminal	#8-32 Screws with captive star lock washer
Mounting	#8 Screw (M4)

Part #	Circuits	Cover	Negative Bus	Positive Bus	[A] Width in (mm)	[B] Mounting Centers in (mm)	[C] Height in (mm)	[D] Mounting Centers in (mm)
5025	6	Yes	#10-32 stud	#10-32 stud	3.32 (84.20)	2.50 (63.50)	4.89 (124.31)	3.88 (95.58)
5028	6	Yes	--	#10-32 stud	3.32 (84.20)	2.50 (63.50)	3.65 (92.76)	2.64 (67.03)
5030	6	--	#10-32 stud	#10-32 stud	3.32 (84.20)	2.50 (63.50)	4.89 (124.31)	3.88 (95.58)
5033	6	--	--	#10-32 stud	3.32 (84.20)	2.50 (63.50)	3.65 (92.76)	2.64 (67.03)
5026	12	Yes	#10-32 stud	#10-32 stud	3.32 (84.20)	2.50 (63.50)	6.47 (164.39)	5.46 (138.66)
5029	12	Yes	--	#10-32 stud	3.32 (84.20)	2.50 (63.50)	5.23 (132.84)	4.22 (107.11)
5031	12	--	#10-32 stud	#10-32 stud	3.32 (84.20)	2.50 (63.50)	6.47 (164.39)	5.46 (138.66)
5034	12	--	--	#10-32 stud	3.32 (84.20)	2.50 (63.50)	5.23 (132.84)	4.22 (107.11)

For the full list of specifications see page 73

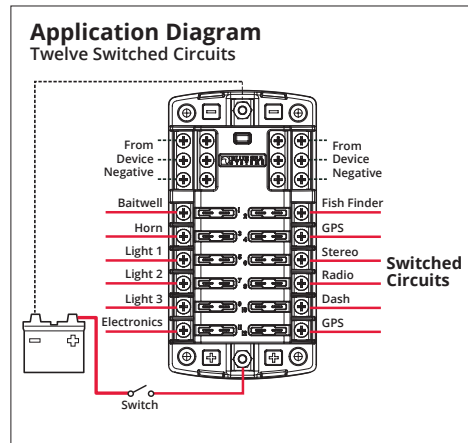
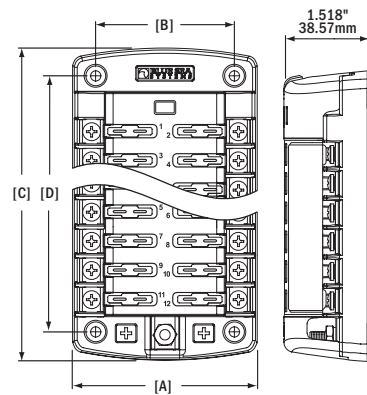

5028 with cover  
5033 without cover



5025 with cover  
5030 without cover



5029 with cover  
5034 without cover



5026 with cover  
5031 without cover

### Related Products



ATO or ATC Fuses  
page 57



easyID ATC Fuses  
page 57



WeatherDeck Switch Only  
page 115

# ST-Blade Compact Fuse Blocks

## Common Source

Provides surface mount circuit protection for ATO or ATC Fuses in a compact footprint. The single side design allows wire entry from one side to maximize space

- Compact common source fuse blocks
- Accepts ATO and ATC fast acting blade fuses
- Single side entry wiring
- Ignition Protected - for use in a gasoline engine compartment
- Insulating cover meets ABYC/USCG insulation requirements
- Tin-plated copper buses and fuse clips
- Accepts ring or snap fork type terminals
- Includes write-on circuit labels for each circuit
- Small format standard and custom labels available
- Fuses sold separately (p. 57)

Voltage Max. Operating	32V DC
Amperage Max. Operating	30A per circuit 100A per block
Fuse Type	ATO or ATC Fuses
Screw Terminal	#8-32 Screws with captive star lock washer
Mounting	#8 Screw (M4)
Regulatory	CE & UKCA certified. Meets ISO 8846 & SAE J1171 external ignition protection requirements

**IGNITION PROTECTED**

Part #	Circuits	Cover
5045	4	Yes
5046	8	Yes

For the full list of specifications see page 73



5045



5046

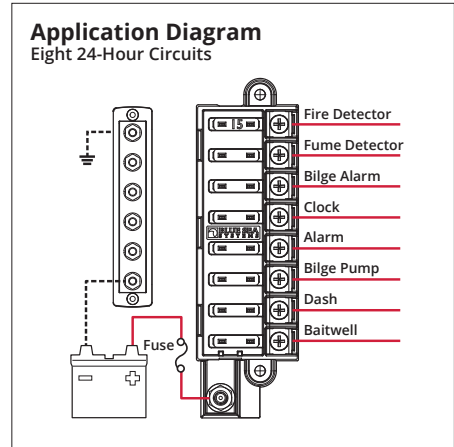
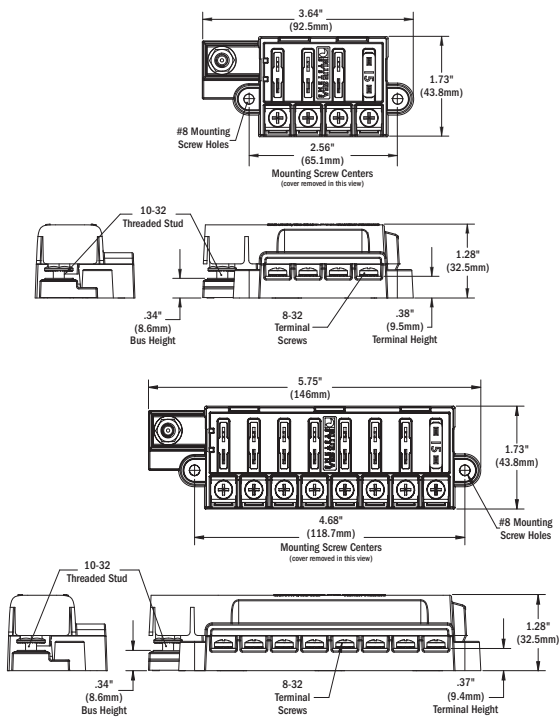

### Related Products



ATO or ATC Fuses  
page 57



easyID ATC Fuses  
page 57

## MRBF Surface Mount Fuse Blocks

### MRBF—Marine Rated Battery Fuse

- Surface mount fuse blocks accommodate three MRBF fuses for consolidated high amperage circuit protection
- The independent source fuse block (5194) is ideal for 3 output battery chargers
- The common source fuse block (5196) provides 3 loads from a single source
- Clip-on cover insulates terminal connections
- Versatile wiring options allow all wires to come out a single side
- Label recesses for easy circuit identification
- One-piece stainless flange nuts ensure safe and secure connections
- Ignition protected when used with MRBF fuses
- Fuses sold separately (p. 58)

Part #	5194	5196
Block Type	Independent Source	Common Source
Fuses	3	3
Voltage Max. Operating	58V DC	58V DC
Amps Max. Operating (using 4/0 cables)	300A per block --	300A per block 240A per circuit
Terminal Fuses Available	30A-300A	30A-300A
Terminal Stud Size	5/16" -18 (8mm)	5/16" -18 (8mm)
Mounting Hole Size	#10 (5mm)	#10 (5mm)
Regulatory	Meets ISO 8846 and SAE J1171 external ignition protection requirements when used with MRBF fuses and cover is securely latched	

**IGNITION PROTECTED**

For the full list of specifications see page 73

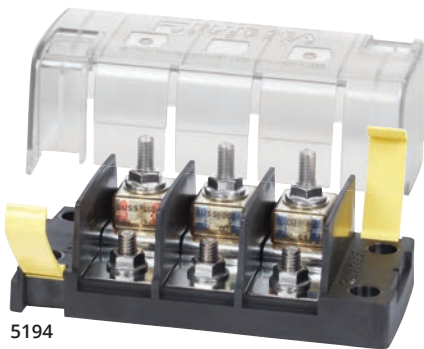

#### Related Products



MRBF Fuses page 58

## MRBF Terminal Fuse Blocks

### MRBF—Marine Rated Battery Fuse

Satisfies ABYC 7" circuit protection rule by mounting on a 3/8" battery post, battery switch, or bus bar

- Appropriate for DC Main, inverter, windlass, and bow thruster circuit protection
- Weatherproof – suitable for small open-cockpit boats and other harsh environments
- Insulating cap prevents accidental shorts
- Ignition protected when used with MRBF fuses
- Fuses sold separately (p. 58)

Part #	5191	2151
Fuses	1	2
Voltage Max. Operating	58V DC	58V DC
Amps Max. Operating (using 4/0 cables)	300A	300A
Terminal Fuses Available	30A-300A	30A-300A
Terminal Stud Size	M8 (5/16"-18)	M8 (5/16"-18)
Mounting Hole Size	3/8"	3/8"
Regulatory	Meets ISO 8846 and SAE J1171 external ignition protection requirements	

**IGNITION PROTECTED**

For the full list of specifications see page 73



## MEGA® or AMG® Fuse Block

Provides an economical system for 100A to 300A fusing

- Insulating cover with breakouts satisfies ABYC/USCG insulation requirements
- Stainless steel studs provide resistance to corrosion and allow high torque
- UL 94-V0 base resists high heat
- Fuses sold separately (p. 58)



Part #	5001
Voltage Max. Operating	32V DC
Amperage Max. Operating	300A
Wire Size to Meet Rating	4/0 AWG (120mm <sup>2</sup> )
Terminal Stud Size	5/16"-18 (M8)
Mounting	#10 (M5) Screws
Fuse Type	MEGA or AMG
Fuses available	100A-300A

For the full list of specifications see page 73

#### Related Products



MEGA or AMG Fuses page 58



## Class-T Fuse Blocks

Allows the use of Class T fuses for fast acting circuit protection of inverters and other electronics



5502

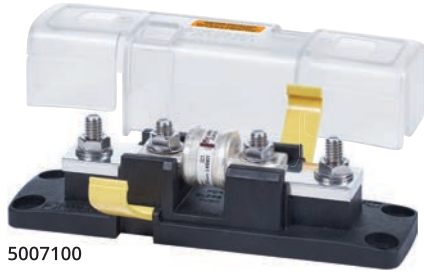

5007100

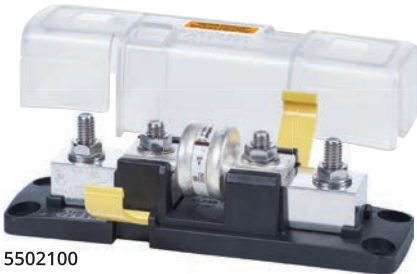

5502100

- Four stud design provides ample access around connecting stud to install large cable lugs without obstruction from the fuse
- Insulating cover satisfies ABYC/USCG insulation requirements
- Cover breakouts allow wire access in any direction
- Stud design ensures secure fuse mounting even with high heat
- Stainless steel studs provide resistance to corrosion and high torque
- One-piece stainless flange nuts ensure safe and secure connections
- UL 94-V0 base resists high heat
- Fuse sold separately (p. 59)

Voltage Max. Operating	160V DC
Mounting	1/4" (M6) Screws
Fuse Mounting Blocks	Tin-Plated Copper
Regulatory	5007100 & 5502100 Meets ISO 8846 and SAE J1171 external ignition protection requirements when cover is secure

**IGNITION PROTECTED** 5007100 & 5502100 ONLY

Part #	Class T Fuses	Terminal Stud Size	Amps Max. Operating
5502	225A-400A	3/8"-16 (M10)	320A
5007100	110A-200A	1/4"-20 (M6)	160A
5502100	225A-400A	5/16"-18 (M8)	320A

For the full list of specifications see page 73

### Related Products



Class-T Fuses  
page 59

## ANL® Fuse Blocks

Accepts a wide range of ANL fuse amperages for versatile fusing



5005



5503

- Swing out design allows replacement of the fuse without removing fasteners
- Insulating cover satisfies ABYC/USCG insulation requirements
- Cover breakouts allow wire access in any direction
- Insert molded studs ensure secure fuse mounting
- Stainless steel studs provide resistance to corrosion and high torque
- One-piece stainless flange nuts ensure safe and secure connections
- UL 94-V0 base resists high heat
- Fuse sold separately (p. 59)

Part #	5503	5505
Fuses	1	1
Voltage Max. Operating	32V DC	32V DC
Amps Max. Operating	750A	300A
ANL Fuses Available	35A-750A	35A-300A
Terminal Stud Size	5/16"-18 (M8)	5/16"-18 (M8)
Mounting	1/4" (M6) Screws	#10 (M5) Screws
Regulatory	Meets ISO 8846 and SAE J1171 external ignition protection requirements	

For the full list of specifications see page 73

### Related Products



ANL Fuses  
page 59

## TECH TIP

### ABYC guidelines and Ignition Protection

**Blue Sea Systems fuse blocks marked ignition protected** are designed and tested for ignition protection, enabling them to be installed in a compartment where gasoline or other explosive fumes may be present.

Blue Sea Systems' fuse blocks that meet the U.S. Coast Guard ignition protection requirements include the MAXI®, ST-Blade Battery Terminal Mount, ST-Blade Compact, Terminal MRBF, some Class-T models, Safety, and SafetyHub Fuse Blocks.

#### The U.S. Coast Guard states:

*An electrical component that is "ignition protected" is capable of operating in an explosive environment without igniting that environment. "Ignition protection" of electrical devices is accomplished by the use of seals, flame arrestors and potting (sealing), or a combination of such means.*

### Safety Fuse Block AMI® or MIDI®

Ignition protected for use on gasoline powered boats with 30A to 200A circuits

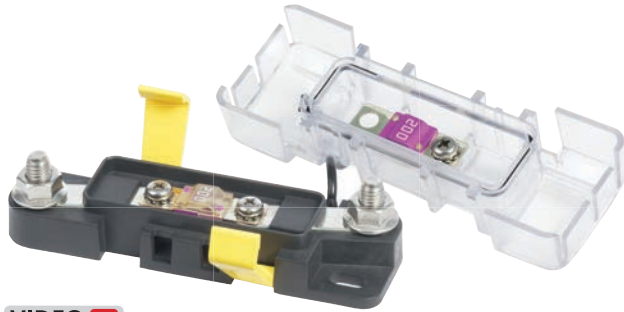

- Sealed cover protects fuses from the harsh marine environment and satisfies ABYC/USCG insulation requirements
- Cover breakouts allow wire access in three directions
- Cover accommodates a spare fuse
- One-piece stainless flange nuts ensure safe and secure connections
- Accepts square format standard or custom label
- Fuses sold separately (p. 58)

Part #	7720
Fuse Type	AMI or MIDI
Fuse Amperages Available	30A-200A
Voltage Max. Operating	32V DC
Wire Size to Meet Rating	2/0 AWG (70 mm <sup>2</sup> )
Mounting holes	Accept 1/4" (M6) Screws
Terminal Stud Size	M8
Terminal Screw Size	M5 Stainless Steel
Regulatory	CE & UKCA certified,, meets ISO 8846 and SAE J1171 external ignition protection requirements when cover is secure, IP66 - protected against powerful water jets (see inside back cover)



For the full list of specifications see page 73

Related Products



AMI or MIDI Fuses page 58

### Safety Fuse Block MEGA® or AMG®

Ignition protected for use on gasoline powered boats with 30A to 300A circuits

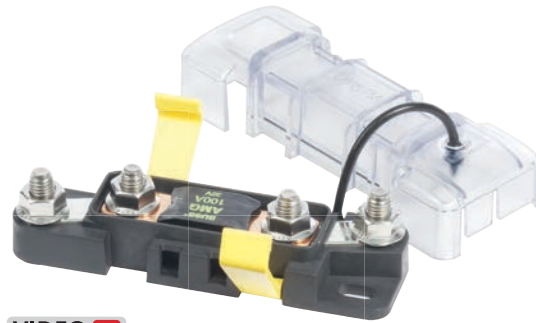

- Sealed cover protects fuses from the harsh marine environment and satisfies ABYC/USCG insulation requirements
- Cover breakouts allow wire access in three directions
- One-piece stainless flange nuts ensure safe and secure connections
- Accepts square format standard or custom label
- Fuses sold separately (p. 58)

Part #	7721
Fuse Type	MEGA or AMG
Fuse Amperages Available	100A-300A
Voltage Max. Operating	32V DC
Wire Size to Meet Rating	2/0 AWG (70 mm <sup>2</sup> )
Mounting holes	Accept 1/4" (M6) Screws
Terminal Stud Size	M8
Regulatory	CE & UKCA certified,, meets ISO 8846 and SAE J1171 external ignition protection requirements when cover is secure, IP66 - protected against powerful water jets (see inside back cover)



For the full list of specifications see page 73

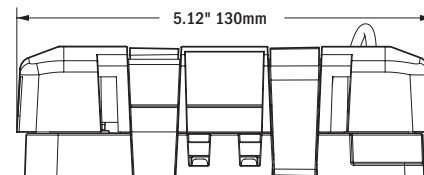
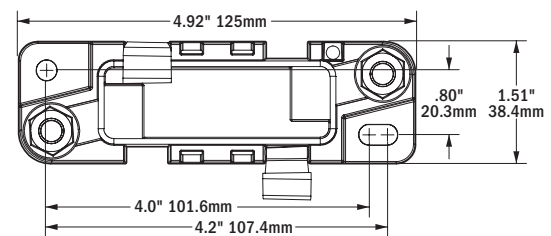

Related Products



MEGA or AMG Fuses page 58

## SafetyHub 100 Fuse Block

The SafetyHub 100 combines an ignition protected fuse block and integrated connecting plugs. It is safe for use on gasoline powered boats, reduces wiring connections, and consolidates up to seven fused circuits



- Accepts three AMI or MIDI Fuses for high-amp circuits including panel feeds, windlasses, and stereo amplifiers
- Accepts four ATO or ATC Fuses for circuits including bilge pumps, electronics and lights
- Sealed cover protects fuses from the harsh marine environment and satisfies ABYC/USCG insulation requirements
- Integrated connector plug eliminates loose wires and provides a secure, waterproof connection
- Fuses sold separately (p. 57-58)

Part #	7725
Amperage Max. Operating (combined)	280A
Voltage Nominal Operating	12V DC
Minimum Cable Size to Meet Ratings	4/0 AWG (120 mm <sup>2</sup> )
Recommended Ring Terminal	M8 (5/16")
<b>MIDI or AMI Fuse Block</b>	
Amperage Max. Operating (per block)	240A†
Amperage Max. Operating (per circuit)	170A†
Fuse Amperages Available	30-200A
Minimum Cable Size to Meet Ratings	2/0 AWG (70 mm)
<b>ATO or ATC Fuse Block</b>	
Amperage Max. Operating (per block)	50A†
Amperage Max. Operating (per circuit)	20A†
Fuse Amperages Available	1A-20A
Regulatory	CE & UKCA certified,, meets ISO 8846 and SAE J1171 external ignition protection requirements when cover is secure, IP66 – protected against powerful water jets (see inside back cover)

† Ratings are dependent on input cable sized for appropriate amperages



For the full list of specifications see page 73

### Related Products



ATO or ATC Fuses  
page 57



easyID ATC Fuses  
page 57



AMI or MIDI Fuses  
page 58

## SafetyHub 150 Fuse Block

The SafetyHub 150 is an ignition protected fuse block with screw termination. It is safe for use on gasoline powered boats, reduces wiring connections, and consolidates up to ten fused circuits

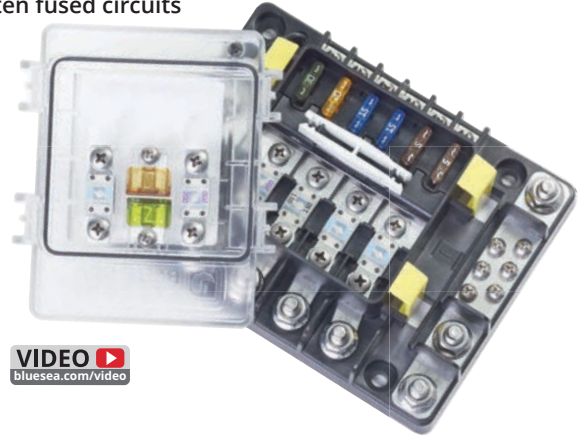

- Accepts four AMI or MIDI Fuses for high-amp circuits including panel feeds, windlasses, and stereo amplifiers
- Accepts six ATO or ATC Fuses for circuits including bilge pumps, electronics and lights
- Sealed cover protects fuses from the harsh marine environment and satisfies ABYC/USCG insulation requirements
- Negative bus provides common location for negative connection
- Circuit identification label with write-on capability
- Fuse puller to remove ATO or ATC Fuses
- Cover provides storage space for spare fuses and mounting screws
- One-piece stainless flange nuts ensure safe and secure connections
- Fuses sold separately (p. 57-58)

Part #	7748
Amperage Max. Operating (combined)	280A
Voltage Max. Operating	32V DC
Minimum Cable Size to Meet Ratings	4/0 AWG (120 mm <sup>2</sup> )
Recommended Ring Terminal	M8 (5/16")
Stud Size	M8
<b>MIDI or AMI Fuse Block</b>	
Amperage Max. Operating (per block)	280A†
Amperage Max. Operating (per circuit)	170A†
Fuse Amperages Available	30-200A
Minimum Cable Size to Meet Ratings	2/0 AWG (70 mm)
Screw Size	M5
<b>ATO or ATC Fuse Block</b>	
Amperage Max. Operating (per block)	50A†
Amperage Max. Operating (per circuit)	25A†
Fuse Amperages Available	1A-20A
Screw Size	#8-32
Regulatory	CE & UKCA certified,, meets ISO 8846 and SAE J1171 external ignition protection requirements when cover is secure, IP66 – protected against powerful water jets (see inside back cover)

† Ratings are dependent on input cable sized for appropriate amperages



For the full list of specifications see page 73



## Fuse Specification Table



Page #	56	56	56	56	57	57	57	57
Product	GMA	AGA	AGC	MDL	ATM	ATO or ATC	easyID	MAXI
Interrupting Capacity DC	--	--	--	--	1,000A DC	1,000A DC	1,000A DC	1,000A DC
Maximum Voltage DC	24V DC	32V DC	32V DC	32V DC	32V DC	32V DC	32V DC	32V DC
Maximum Voltage AC	5-10A: 125V AC 1-3A: 250V AC	-	.25-10A: 250V AC	3-7.5A: 250V AC	--	--	--	--
Amperage Range	1-10A	20A	.5-30A	3-30A	2-30A	1-30A	3-40A	30-80A
Quantity Per Package	3	5	5 or 25	2	2	2 or 25	2	1

\* Certain amperages of GMA®, AGC®, and MDL® fuses are AC/DC rated. See product page for specific ratings



Page #	58	58	58	59	59
Product	MRBF	AMI or MIDI	MEGA or AMG	Class-T	ANL
Interrupting Capacity	10,000A @ 14V DC 5,000A @ 32V DC 2,000A @ 58V DC	5,000A @ 16V DC 2,000A @ 32V DC	2,000A @ 32V DC	20,000A @ 125V DC	6,000A @ 32V DC
Maximum Voltage	58V DC	32V DC	32V DC	125V DC	32V DC
Amperage Range	30-300A	30-200A	100-300A	110-400A	35-750A
Quantity Per Package	1	2	1	1	1
Regulatory	SAE J1171 IP66 – protected against powerful water jets.	ISO 8846 and SAE J1171 when used with Blue Sea Systems' SafetyHubs and Safety Fuse Block Part # 7720.	ISO 8846 and SAE J1171 when used with Blue Sea Systems' Safety Fuse Block Part # 7721.	--	35-500A Meets ISO 8846 and SAE J1171.

## In-Line Fuse Holder Specification Table



Part #	5060	5061	5062	5063	5021	5064	5065	5068
Page #	60	60	60	60	60	60	60	60
Product	Crimpable	Waterproof	Waterproof	Heavy Duty	Water Resistant	ATO or ATC	Waterproof ATO or ATC	MAXI
For use with	AGC or MDL	AGC or MDL	AGC or MDL	AGC or MDL	AGC or MDL	ATO or ATC	ATO or ATC	MAXI
Wire Size	12-16 AWG	12-18 AWG	12-16 AWG	12 AWG Pigtails	--	12 AWG Pigtails	12 AWG Pigtails	#6 Red Lead Wire
Max. Amperage	30A per circuit	30A per circuit	20A per circuit	30A per circuit	20A per circuit	30A per circuit	30A per circuit	60A per circuit
Regulatory	--	--	--	--	IP66 on front – protected against powerful water jets.	--	--	--

### Fuse Block Specification Table



Part #	5006100	5015 & 5018	5056 & 5056100	5023	5035 & 5037	5032	5028, 5025, 5029 & 5026	5045 & 5046
Page #	61	61	62	63	64	65	66	67
Product	MAXI	ST-Glass				ST-Blade		
For use with	MAXI	AGC or MDL	ATO or ATC	ATO or ATC	ATO or ATC	ATO or ATC	ATO or ATC	ATO or ATC
Maximum Voltage	32V DC	32V DC	32V DC	32V DC	32V DC	32V DC	32V DC	32V DC
Maximum Amperage per circuit	80A	30A	25A	30A	30A	30A	30A	30A
Maximum Amperage per block	80A	100A	80A	100A	40A per jumped circuit group	100A (not to exceed 80A per load group)	100A	100A
Available Fuses	30-80A	.25-30A	1-30A	1-30A	1-30A	1-30A	30-300A	1-30A
Ingress Protected	--	--	IP66-protected against powerful water jets.	--	--	--	--	IP66-protected against powerful water jets.
Ignition Protected	ISO 8846, SAE J1171 when cover is secure.	--	--	ISO 8846, SAE J1171 when cover is secure.	--	--	--	ISO 8846, SAE J1171 when cover is secure.



Part #	2151 & 5191	5194	5196	5001	5502	5007100	5502100
Page #	68	68	68	69	69	69	69
Product	MRBF Terminal	MRBF Surface	MRBF Surface	MEGA or AMG	Class-T	Class-T	Class-T
For use with	Terminal (MRBF)	Terminal (MRBF)	Terminal (MRBF)	MEGA or AMG	Class-T	Class-T	Class T
Maximum Voltage	58V DC		58V DC	32V DC	160V DC	160V DC	160V DC
Maximum Amperage per circuit	300A	240A	240A	300A	320A	160A	320A
Maximum Amperage per block	300A	--	300A	300A	320A	160A	320A
Available Fuses	30-300A	30-300A	30-300A	100-300A	225-400A	110-200A	225-400A
Ingress Protected	IP66 when used with Blue Sea Systems' Terminal (MRBF) Fuses.	--	--	--	--	--	--
Ignition Protected		SAE J1171 when used with Blue Sea Systems' MRBF fuses.		--	--	ISO 8846, SAE J1171 when cover is secure.	ISO 8846, SAE J1171 when cover is secure.



Part #	5005	5503	7720 & 7721	7725	7748
Page #	69	70	70		71
Product	ANL	ANL	Safety	SafetyHub 100	SafetyHub 150
For use with	ANL	ANL	7720: AMI or MIDI 7721: MEGA or AMG	AMI or MIDI and ATO or ATC	
Maximum Voltage	32V DC	32V DC	32V DC	12V DC	32V DC
Maximum Amperage per circuit	300A	750A	7720: 200A 7721: 300A	AMI or MIDI: 250A ATO or ATC: 30A	AMI or MIDI: 170A ATO or ATC: 25A
Maximum Amperage per block	300A	750A	7720: 200A 7721: 300A	ATO or ATC: 50A	AMI or MIDI: 280A ATO or ATC: 50A
Maximum Total Amperage (combined)	35-300A	--	--	280A	280A
Available Fuses	--	35-750A	7720: 30-200A 7721: 100-300A	AMI or MIDI: 30-200A ATO or ATC: 1-30A	AMI or MIDI: 30-200A ATO or ATC: 1-30A
Ingress Protected	--	--		IP66-protected against powerful water jets.	
Ignition Protected	--	--		ISO 8846, SAE J1171 when cover is secure.	

## ST-CLB Circuit Breaker Blocks

Compact surface mount solution providing secure screw termination where Push Button Reset-Only CLB Circuit Breakers are desired

- Clear insulating cover with square format label recesses, satisfies ABYC/USCG insulation requirements
- Quick connect clips allow circuit breakers to snap easily into place
- Tin-plated copper busses and screw terminals
- Breakouts allow wire access in two directions
- Accepts ring terminals
- Optional push button waterproof boots or dress nuts can be installed over cover
- Accepts square labels
- Optional jumper 5049, for use with 5050 and 5051
- Circuit breakers sold separately (p. 75)



Voltage Max. Operating	32V DC
Amperage Max. Operating	32A (per circuit)
Amperage Max. Operating	100A (per block - common source)
Amperage Max. Operating	40A (per jumped circuit group - independent source)
Temp. Operating Range	-10°C to 60°C
Breaker Type	Push Button Reset-Only Circuit Breaker with Quick Connect Terminals
Screw Terminal	#8-32 Screws with Captive Star Lock Washer
Ring Terminals	Screw Terminals #8 (M4), Negative Bus #10 (M5)
Mounting	#8 Screw (M4) or #8 Nut

Part #	Positions	Negative Bus	Source	[A] Mounting Centers in (mm)	[B] Mounting Centers in (mm)	[C] Height in (mm)
5050	6	--	Independent	5.63 (142.9)	1.40 (35.6)	6.69 (169.9)
5051	12	--	Independent	10.13 (257.2)	1.71 (43.4)	11.19 (284.2)
5052	6	#10-32 stud	Common	5.63 (142.9)	1.40 (35.6)	6.69 (169.9)
5054	12	#10-32 stud	Common	10.13 (257.2)	1.71 (43.4)	11.19 (284.2)
5049	ST CLB Block Jumper, 5 per pack					



5050

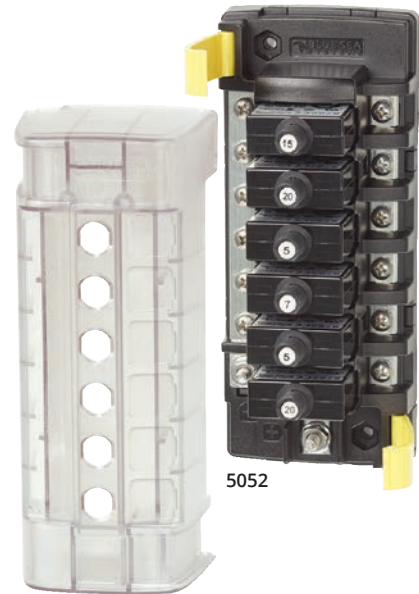

5052

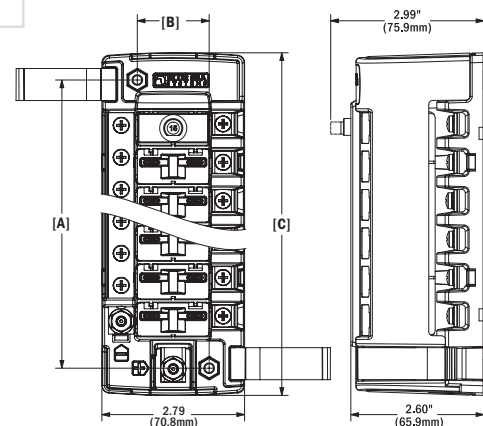
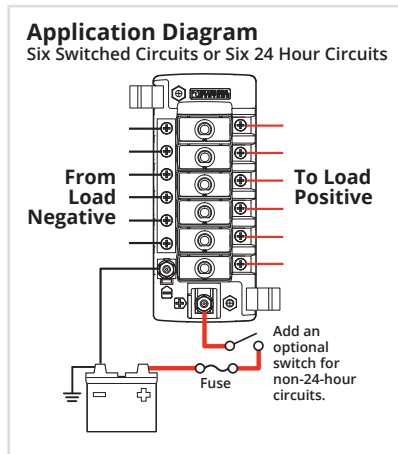
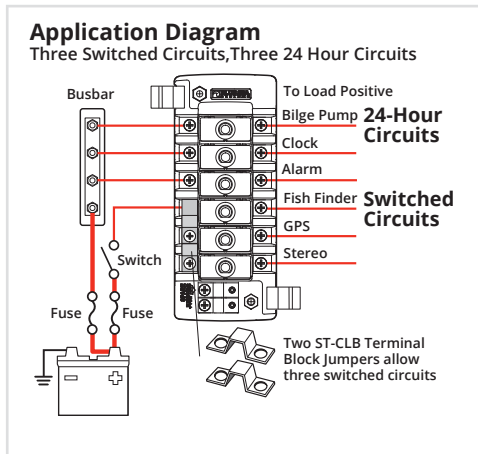

### Related Products



ST-CLB Circuit Breaker Block Jumper 5049 (see table)



CLB Circuit Breaker Boots page 75



Push Button Reset-Only CLB Circuit Breakers page 75



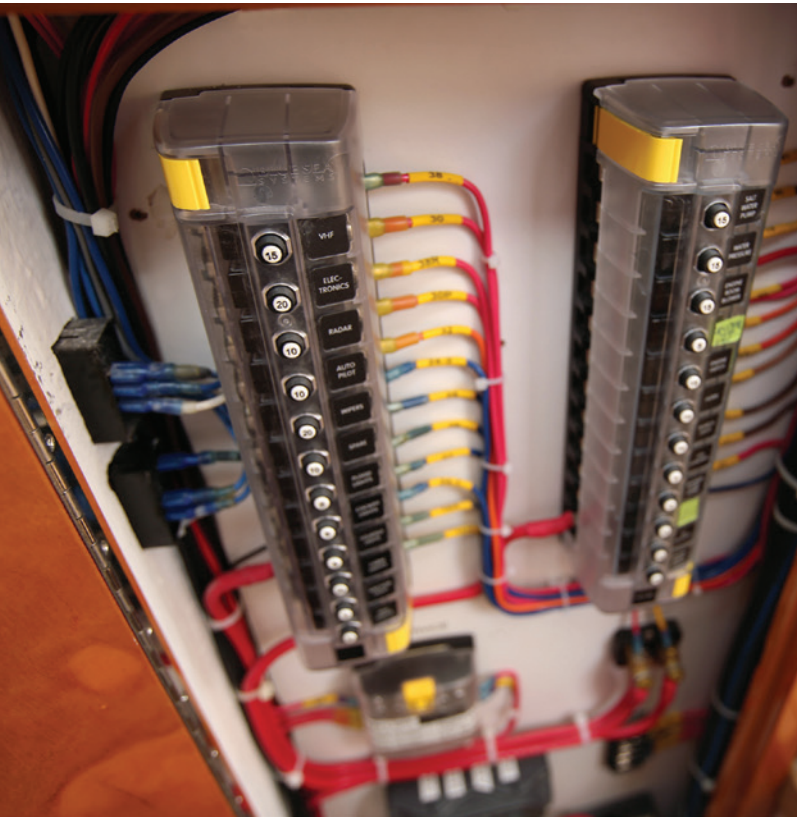

True North Yachts installs ST-CLB blocks aboard their boats, including the True North 38.

## Push Button Reset-Only CLB Circuit Breakers

Provides economical circuit protection for 3A to 40A loads when switching is provided elsewhere or not required

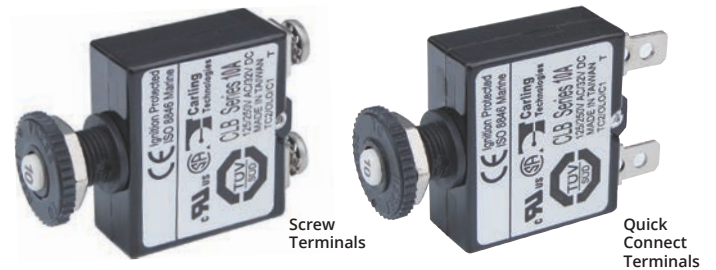

- Quick connect or screw terminal style
- Compact design enables high density circuit protection configurations
- Push-to-reset operation
- Trip Free design cannot be held ON during fault current condition
- Optional push button waterproof boot

Interrupting Capacity	3,000A @ 14.7V DC / 2,500A @ 28V DC
Voltage Max. Operating	32V DC
Temperature Min. Operating	-10°C
Temperature Max. Operating	60°C
Type	Thermal trip, manual reset
Terminals	#8 Screw Terminals (ST) or 1/4" Male Quick Connect (QC) Terminals
Screw Terminal Torque	6 in-lb max.
Trip Time Delay	See <a href="http://blueseas.com">blueseas.com</a>
Thread	3/8"-27 UNS
Regulatory	CE marked, UL Recognized - UL 1077 - UL/cUL (USA and Canada), TUV certified, EN 60934, meets UL 1500 and ISO 8846 external ignition protection requirements

## CLB Circuit Breaker Waterproof Boots

Protects push button circuit breakers in wet environments

- Used on waterproof panels (p. 114-115)
- Replaces dress nut mounting on circuit breakers

Thread Material	Nickel-Plated Brass
Thread	3/8"-27
Regulatory	IP67 - protected against immersion up to 1 meter for 30 minutes



Part #	Description	Retail Pack
4135	Clear	2
4136	White	2
4137	Black	2

### IGNITION PROTECTED

Screw Terminals Part #	QC Terminals Part #	Amps
2129	7050	3A DC
2130	7052	5A DC
2131	7053	7A DC
2132	7054	10A DC
2133	7056	15A DC
2134	7057	20A DC
2135	7058	25A DC
2136	7059	30A DC
2137	7061	40A DC

See p. 166 for ABYC Interrupting Capacity Requirements.

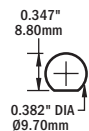

Cutout Dimensions

### Related Products



Contura Circuit Breaker Panels page 114



WeatherDeck Circuit Breaker Panels page 115



DC Branch Circuit Breaker Panels page 118



360 Panel Adapter page 96

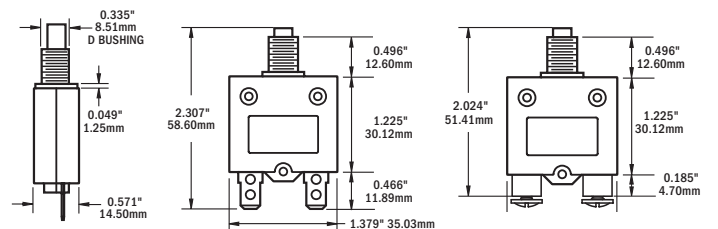

1/4" Male Quick Connect Terminals

#8 Screw Terminals

## Medium Duty Push Button Reset-Only Circuit Breakers

Provides circuit protection for 15A to 60A loads when switching is provided elsewhere or not required

- Weatherproof
- Can be used as Main or Branch
- Push-to-reset operation
- Trip Free design cannot be held ON during fault current condition
- Captive star lock washers meet requirements for anti-rotation and eliminate handling of small, easily dropped parts

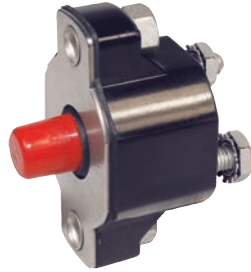

Interrupting Capacity	5,000A @ 32V DC 3,000A @ 120V AC
Voltage Max. Operating	32V DC / 120V AC
Temperature Min. Operating	-54°C
Temperature Max. Operating	74°C
Type	Thermal trip, manual reset
Terminal Stud	#10-32 Stainless Steel
Terminal Stud Torque	30 in-lb max.
Trip Time Delay	See <a href="http://blueseas.com">blueseas.com</a>
Mounting Thread	#8 -32
Regulatory	SAE J553, UL 1077, meets UL 1500 external ignition protection requirements

**IGNITION PROTECTED**

Part #	Amps
2138	15A DC
2139	20A DC
2140	30A DC
2141	40A DC
2142	50A DC
2143	60A DC

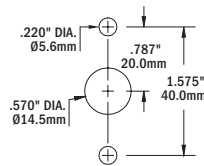

Cutout Dimensions

See p. 164 for ABYC Interrupting Capacity Requirements.

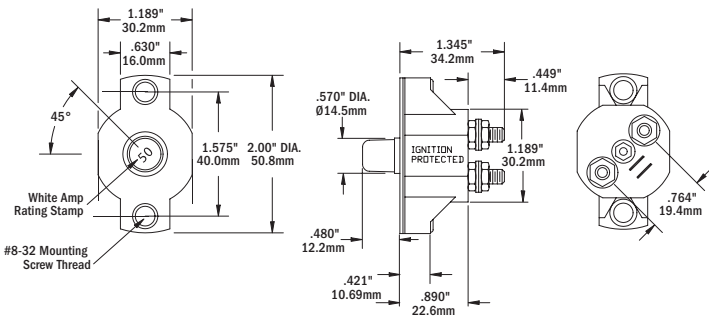

## Carling C1005B Circuit Breaker

Combination switch and thermal circuit breaker with illuminated On indication

- Illuminated 15A circuit breaker provides switching and overcurrent protection
- Used with Blue Sea Systems' Water-Resistant Accessory and Circuit Breaker Switch Panels
- Compact design fits industry-standard aperture
- Quick connect tabs make wiring simple
- Trip free - cannot be held closed after trip



Part #	7069
Interrupting Capacity	1,000A AC 1,000A DC
Voltage Max. Operating	250V AC / 32V DC
Temperature Min. Operating	-10°C
Temperature Max. Operating	65°C
Type	Thermal trip, manual reset
Terminals	1/4" Male Quick Connect
Trip Time Delay	See <a href="http://blueseas.com">blueseas.com</a>
Regulatory	UL 1107, UL 1363, IEC 60934

See p. 164 for ABYC Interrupting Capacity Requirements.

## Water-Resistant Circuit Breaker Boot

Protects Carling C1005B Circuit Breaker 7069 in wet environments

- Used on Water-Resistant Accessory Panels and Water-Resistant Circuit Breaker Switch Panels
- Fits 7069 circuit breaker switches

Part #	4134
Quantity	6
Material	Clear Silicone



Shown installed in a Water-Resistant Circuit Breaker Switch Panel

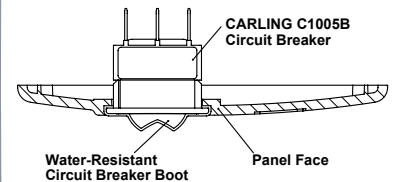

Top View

### Related Products



Water-Resistant Circuit Breaker Switch Panels page 113



Water-Resistant Accessory Panels page 26

## Marine Grade Short Stop Circuit Breakers

Use a circuit breaker instead of a fuse

- Designed with corrosion resistant materials to withstand harsh environments
- IP64 water-resistant boot protects against dust and splashing water
- Push-to-reset operation only disconnects when tripped
- Stainless steel nyloc nuts for secure connections
- Red insulating boot included in retail package only



Interrupting Capacity	2,500A @ 28V DC
Voltage Max. Operating	28V DC
Temperature Min. Operating	-10°C
Temperature Max. Operating	60°C
Type	Thermal trip, manual reset
Terminals	#10-32" Studs
Screw Terminal Torque	24 in-lb max.
Trip Time Delay	See <a href="http://blueseas.com">blueseas.com</a>
Regulatory	IP64, SAE J553, meets SAE J1171 external ignition protection requirements

**IGNITION PROTECTED**

Part #	Amps
7151	10A DC
7152	15A DC
7153	20A DC
7154	25A DC
7155	30A DC
7156	40A DC
7157	50A DC
7160	Insulating Boot

See p. 164 for ABYC Interrupting Capacity Requirements.

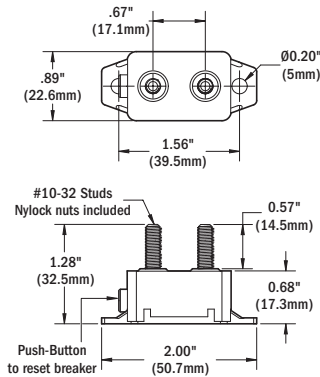

## ATO®/ATC®-Style Low Profile Circuit Breakers

Use a manually resettable circuit breaker instead of an ATO or ATC fuse

- Drop in replacement for ATO and ATC blade style fuses
- Manual push button reset complies with ABYC circuit protection requirements
- Compatible with Water-Resistant ST-Blade Fuse Block (5056) with cover secured (p. 62)
- Compatible with all other ST-Blade Fuse blocks without cover

Interrupting Capacity	2,000A @ 28V DC
Voltage Max. Operating	32V DC
Temperature Min. Operating	-40°C (-40°F)
Temperature Max. Operating	85°C (185°F)
Type	Thermal trip, manual reset
Trip Time Delay	See <a href="http://blueseas.com">blueseas.com</a>
Regulatory	SAE J553, UL 1500, ISO 10924-4, meets SAE J1171 external ignition protection requirements

**IGNITION PROTECTED**



Part #	Amps	Color	Retail Pack
7062	5A	LT. Brown	2
7063	7.5A	Moss Green	2
7064	10A	Red	2
7065	15A	Blue	2
7066	20A	Yellow	2
7067	25A	White	2
7068	30A	Green	2

See p. 164 for ABYC Interrupting Capacity Requirements.

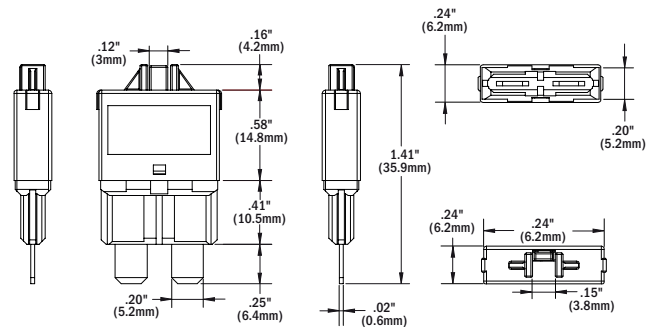

**Related Product**



ST-Blade Water-Resistant Fuse Block page 62



## 285-Series Circuit Breakers

Provides circuit protection for 25A to 150A loads when switching and circuit protection are both required

- Visible yellow reset lever shows open condition
- Trip-free design cannot be held closed after trip
- Drop in replacement for 185-Series Circuit Breakers
- 3,000A AIC for medium battery banks

Interrupting Capacity	3,000A @ 48V DC†
Voltage Max. Operating	48V DC
Temperature Operating	-40°C to 85°C (-40°F-185°F)
Type	Thermal
Class	Thermal Reset – Trip Free
Terminal Stud	M6 (accepts 1/4" Ring Terminal)
Terminal Stud Torque	50 in-lb (7.9 Nm)
Mounting Hole	Accepts 1/4" screw (M6)
Regulatory	CE marked, meets SAE J1171 external ignition protection requirements, IP67 – protected against immersion up to 1 meter for 30 minutes (see inside back cover)

**IGNITION PROTECTED**

†AIC ratings achieved using SAE J1625

Panel Mount Part #	Surface Mount Part #	Amps
7080	7180	25A DC
7081	7181	30A DC
7082	7182	40A DC
7083	7183	50A DC
7084	7184	60A DC
7085	7185	70A DC
7086	7186	80A DC
7087	7187	100A DC
7088	7188	120A DC
7089	7189	150A DC

See p. 164 for ABYC Interrupting Capacity Requirements.

### Related Product



2719 Enclosure page 102

## Circuit Breaker Mounting Options

Provides mounting for Cooper Bussmann® Klixon, 285-Series or 185-Series Panel Mount Circuit Breakers



7198



7098



1477

Part #	Description	Width in (mm)	Height in (mm)
7198	Self-trimming molded rubber bezel	2.44 (61.90)	3.31 (84.07)
7098	Circuit breaker adapter bezel allows circuit breaker mounting in a 2-1/8" round hole	2.44 (61.90)	3.31 (84.07)
1477	Provides circuit breaker mounting in the 360 Panel System	4.88 (123.83)	4.75 (120.65)



Main circuit protection for battery banks up to



7087

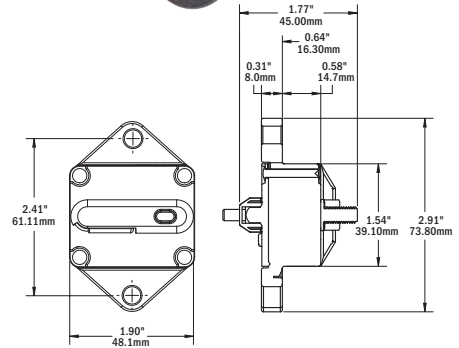

7187

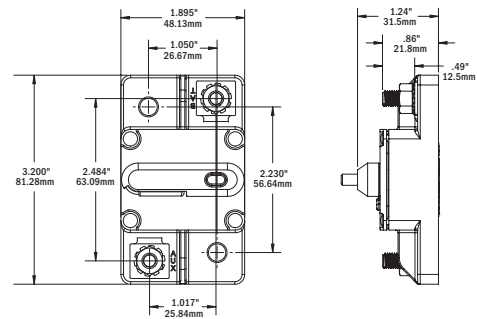

# 187-Series Circuit Breakers

Provides circuit protection for 25A to 200A loads when switching and circuit protection are both required

- Self-trimming case eliminates need for mounting panels or trim bezels
- Visible yellow reset lever shows open condition
- Trip-free design cannot be held closed after trip
- Large clearance around terminal studs accepts up to 1/0 AWG lugs
- Recessed mounting holes for clean appearance
- Robust 5/16"-18 terminals provide high torque connections
- 5,000A AIC for large battery banks



Main circuit protection for battery banks up to



7044

Interrupting Capacity	5,000A @ 14V DC 3,000A @ 28V DC 1,500A @ 48V DC
Voltage Max. Operating	48V DC
Temperature Operating	-40°C to 85°C (-40°F-185°F)
Type	Thermal
Class	Type III – Switchable/Manual Reset – Trip Free
Terminal Stud	5/16"-18
Terminal Stud Torque	75 in-lb max.
Trip Time Delay	See <a href="http://blueseas.com">blueseas.com</a>
Mounting Hole	Accepts #10 (M5) Screw
Regulatory	CE marked, meets SAE J1171 external ignition protection requirements, IP66 – protected against powerful water jets (see inside back cover)

**IGNITION PROTECTED**

Panel Mount Part #	Surface Mount Part #	Amps
7035	7135	25A DC
7036	7136	30A DC
7038	7138	40A DC
7039	7139	50A DC
7040	7140	60A DC
7041	7141	70A DC
7042	7142	80A DC
7043	7143	90A DC
7044	7144	100A DC
7046	7146	120A DC
7047	7147	135A DC
7048	7148	150A DC
7049	7149	200A DC

See p. 164 for ABYC Interrupting Capacity Requirements.

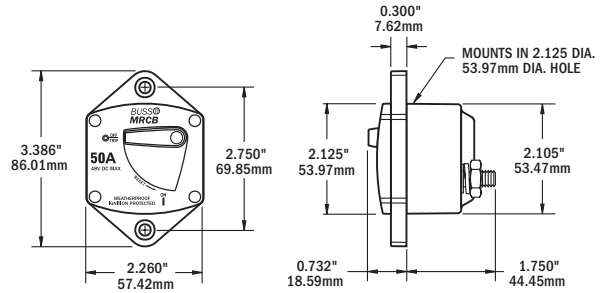

7140

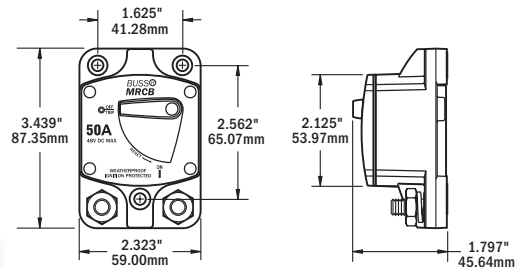

Grady White uses Blue Sea Systems 187 Series Thermal Circuit Breakers aboard their boats, including the Express 336.

### COTS Circuit Breakers Water-Resistant

Suitable for use when government specifications are required

Interrupting Capacity DC	5,000A @ 32V DC, UL 1077-U2, OL1 7,500A @ 65V DC, UL 1077-U1, OL1
Interrupting Capacity AC	2,000A @ 125V AC UL 1077-U2, OL1 5,000A @ 250V AC, UL 1077-U1, OL1
Voltage Max. Operating	65V DC / 277V AC
Temperature Operating	-40°C to 85°C (-40°F-185°F)
Switching Cycles	6000 Electrical, 4000 Mechanical
Type	Magnetic Hydraulic – Trip free A-Series, metal Toggle
Terminal Screw	#10-32 SS
Terminal Screw Torque	14-15 in-lb
Mounting Screw	#6-32 SS
Mounting Screw Torque	7-9 in/lb
Mounting Boss	1/2-32 Hex Nut SS
Mounting Nut Torque	30 in-lb max.
Regulatory	UL 1077, CSA accepted, Water Resistant - designed and tested in accordance with the MIL-PRF-55629 and MIL—STD-202 specifications

Part #	Amps	Poles	Actuator Style
7310	5A	2	Toggle
7311	10A	2	Toggle
7312	15A	2	Toggle
7313	20A	2	Toggle
7314	25A	2	Toggle
7315	30A	2	Toggle
7316	40A	2	Toggle
7317	50A	2	Toggle



7312

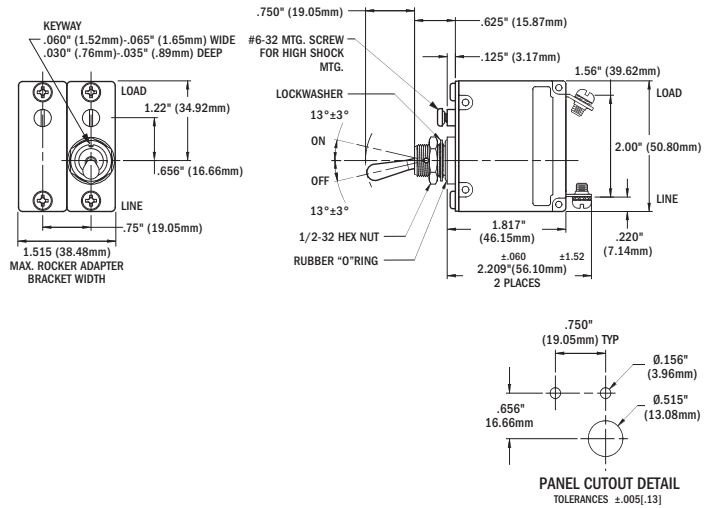

Metal Shark boats builds custom aluminum boats for government agencies. The Custom 360 Panel with Mil-Spec Toggle Circuit Breakers is housed inside the center console and distributes power to critical loads aboard the Relentless 28.





# UL-489 Circuit Breakers

Expanded line of circuit breakers that meet CFR 46 / CoastGuard requirements

Part #	7440-7446	7454-7459	7461-7467
Interrupting Capacity	10,000A	5,000A	5,000A
Voltage Max. Operating	80V DC	240V AC	240V AC
Temperature Operating	-40°C to 85°C (-40°F-185°F)	-40°C to 85°C (-40°F-185°F)	-40°C to 85°C (-40°F-185°F)
Type	C-Series, Magnetic Hydraulic - Trip free	C-Series, Magnetic Hydraulic - Trip free	C-Series, Magnetic Hydraulic - Trip free
Terminal	#10-32 Screw* Tin-Plated Brass	#10-32 Screw Tin-Plated Brass	1/4"-20 Stud Tin-Plated Brass
Terminal Torque	15-20 in-lb*	15-20 in-lb	35 in-lb
Mounting Screw	#6-32 SS	#6-32 SS	#6-32 SS
Mounting Screw Torque	7-9 in-lb	7-9 in-lb	7-9 in-lb
Regulatory	UL 489, CSA certified, TUV certified		

\* 7446 - Terminal - 1/4"-20 Stud, Terminal Torque - 30-35 in-lb

Part #	Amps	Poles	Actuator Style	Part #	Amps	Poles	Actuator Style
7440	5A DC	1	Flat Rocker	7461	10A AC	2	Flat Rocker
7441	10A DC	1	Flat Rocker	7462	15A AC	2	Flat Rocker
7442	15A DC	1	Flat Rocker	7463	20A AC	2	Flat Rocker
7443	20A DC	1	Flat Rocker	7464	25A AC	2	Flat Rocker
7444	30A DC	1	Flat Rocker	7465	30A AC	2	Flat Rocker
7445	50A DC	1	Flat Rocker	7466	30A AC	2	Raised Rocker
7446	100A DC	1	Flat Rocker	7467	50A AC	2	Raised Rocker

Part #	Amps	Poles	Actuator Style
7454	5A AC	1	Flat Rocker
7455	10A AC	1	Flat Rocker
7456	15A AC	1	Flat Rocker
7457	20A AC	1	Flat Rocker
7458	30A AC	1	Flat Rocker
7459	50A AC	1	Flat Rocker

### Related Products



SMS Panel Enclosures page 88



7440



7454



7464



7466

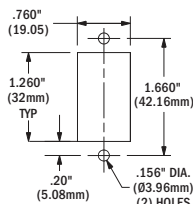
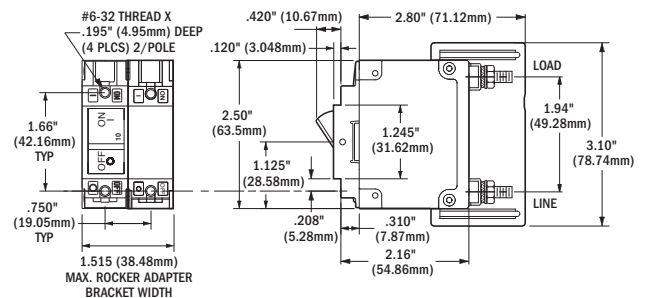
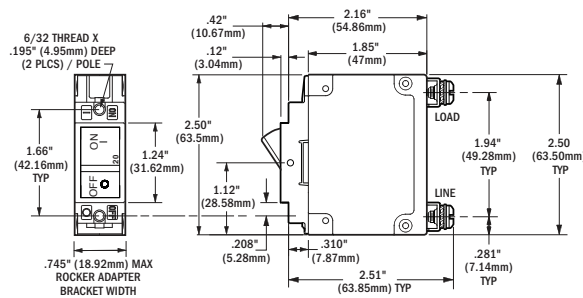

PANEL CUTOUT DETAIL

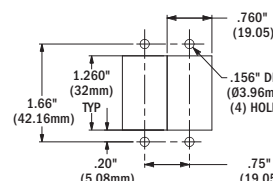

PANEL CUTOUT DETAIL

## A-Series Toggle Circuit Breakers

Combines switching and circuit protection into a single device



7202

7200

7233

- The standard circuit breaker for Blue Sea Systems Traditional Metal Power Distribution Panels
- Single pole is frequently for AC or DC Branch circuit protection
- Double pole is typically for AC Main circuit protection
- Trip Free – cannot be held closed after trip

Voltage Nominal Operating	120/240V AC
Temperature Operating	-40°C to 85°C (-40°F to 185°F)
Switching Cycles	10,000 @ rated amps and volts
Type	Magnetic Hydraulic – Trip free
Terminal Screw	#10-32 Stainless Steel
Terminal Screw Torque	14–15 in-lb Recommended
Trip Time Delay	See <a href="http://blueseas.com">blueseas.com</a>
Mounting Screw	#6-32 Stainless Steel (included)
Mounting Nut Torque	6–8 in-lb Recommended
Regulatory	CE marked, TUV certified, CSA certified, UL 1077 recognized

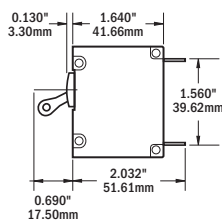
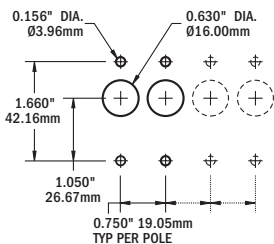
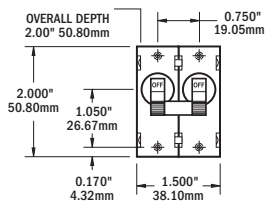
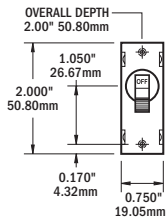

### Cutout Dimensions

### Related Products



360 Panel System  
page 116



Traditional Metal Panel  
page 117

Part #	Color	Amps	Poles	Max.	Part #	Color	Amps	Poles	Max.
7197	White	2.5A	1	65V DC	7232	Black	10A	2	65V DC
7200	Black	5A	1	65V DC	7233	White	10A	2	65V DC
7201	Red	5A	1	65V DC	7234	Black	15A	2	65V DC
7202	White	5A	1	65V DC	7235	White	15A	2	65V DC
7347	Black	8A	1	65V DC	7348	Black	16A	2	65V DC
7299	White	8A	1	65V DC	7294	White	16A	2	65V DC
7204	Black	10A	1	65V DC	7236	Black	20A	2	65V DC
7205	Red	10A	1	65V DC	7260	White	20A	2	65V DC
7206	White	10A	1	65V DC	7237	Black	30A	2	65V DC
7208	Black	15A	1	65V DC	7238	White	30A	2	65V DC
7209	Red	15A	1	65V DC	7349	Black	32A	2	65V DC
7210	White	15A	1	65V DC	7295	White	32A	2	65V DC
7212	Black	20A	1	65V DC	7239	Black	40A	2	65V DC
7213	Red	20A	1	65V DC	7240	White	40A	2	65V DC
7214	White	20A	1	65V DC	7241	Black	50A	2	65V DC
7216	Black	25A	1	65V DC	7242	White	50A	2	65V DC
7217	Red	25A	1	65V DC					
7218	White	25A	1	65V DC					
7220	Black	30A	1	65V DC					
7221	Red	30A	1	65V DC					
7222	White	30A	1	65V DC					
7224	Black	40A	1	65V DC					
7225	Red	40A	1	65V DC					
7226	White	40A	1	65V DC					
7228	Black	50A	1	65V DC					
7229	Red	50A	1	65V DC					
7230	White	50A	1	65V DC					

### Interrupting Capacity Table (see ABYC Requirements p. 164)

	UL 1077 - UL/CSA (US/Canada)			EN60934 - TUV (Europe)	
	Volts	Amps	DC Interrupt	AC Interrupt	AC Interrupt
1 Pole	32V DC	--	5,000A, U2, OL1	--	--
	65V DC	--	7,500A, U1, OL1	--	--
	125V AC	--	--	2,000A, U2, OL1	--
		250V AC	2-30A	--	1,500A, U2, OL0
2 Pole	32V DC	--	5,000A, U2, OL1	--	--
	65V DC	--	7,500A, U1, OL1	--	--
	125V AC	--	--	3,000A, U2, OL1	--
		250V AC	2-30A	--	3,000A, U2, OL1
		40-50A	--	3,000A, U2, OL0	

## Circuit Breaker Mounting Options

- 3131, Strain reliefs included, accepts A-Series Toggle and A and C-Series Flat Rocker Circuit Breakers, Square Format Labels (p. 154), and LEDs (p. 153)
- 8072 and 8173, Accepts A-Series Toggle Circuit Breakers, Large Format Labels (p. 154), and LEDs (p. 153)



3131



8072



8173

Part #	Description	Width in (mm)	Height in (mm)	Depth in (mm)
3131	Enclosure	3.95 (100.36)	4.92 (124.91)	4.07 (103.40)
8072	1 Pole mounting panel	2.63 (66.80)	3.75 (92.25)	0.125 (3.175)
8173	2 Pole mounting panel	2.63 (66.80)	3.75 (92.25)	0.125 (3.175)

# A-Series Rocker Circuit Breakers

Combines switching and circuit protection into a single device



7403

**Flat Rocker**

- Standard circuit breaker used on the 360 Panel System (1200 Series)
- Flat actuator resists accidental switching by being flush in the ON position

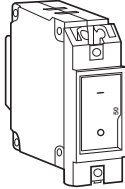

7425

**Restricted-Off Rocker**

- Actuator shows white in the OFF position
- Restricted OFF actuator can only be switched to OFF by insertion of small screwdriver into slot

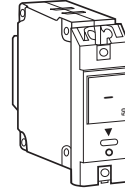

7574

**Raised Rocker**

- Standard circuit breaker for AC Source Select panels in the 360 Panel System

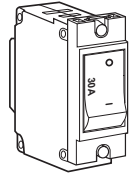

- White actuator indicates OFF position
- Single pole is available in Flat Rocker and Restricted Off styles
- Single pole is frequently used for AC or DC Branch circuit protection
- Double pole is available in Flat Rocker and Raised Rocker styles
- Double pole is typically used for AC Main circuit protection
- Raised Rocker actuator style is used for AC source selection on the 360 Panel System
- International ON and OFF symbols support vertical or horizontal mounting

Voltage Nominal Operating	120/240V AC
Temperature Operating	-40°C to 85°C (-40°F to 185°F)
Switching Cycles	10,000 @ rated amps and volts
Type	Magnetic Hydraulic - Trip free
Terminal Screw	#10-32 Stainless Steel
Terminal Screw Torque	14-15 in-lb Recommended
Trip Time Delay	See <a href="http://blueseas.com">blueseas.com</a>
Mounting Screw	#6-32 Stainless Steel (included)
Mounting Nut Torque	6-8 in-lb Recommended
Regulatory	CE marked, TUV certified, CSA certified, UL 1077 recognized

Part #	Amps	Max.	Poles	Rocker Actuator
7399	2.5A	32V DC	1	Flat
7400	5A	32V DC	1	Flat
7425	5A	32V DC	1	Restricted-OFF
7401	8A	32V DC	1	Flat
7402	10A	32V DC	1	Flat
7427	10A	32V DC	1	Restricted-OFF
7403	15A	32V DC	1	Flat
7428	15A	32V DC	1	Restricted-OFF
7404	20A	32V DC	1	Flat
7429	20A	32V DC	1	Restricted-OFF
7405	25A	32V DC	1	Flat
7430	25A	32V DC	1	Restricted-OFF
7406	30A	32V DC	1	Flat
7407	40A	32V DC	1	Flat
7408	50A	32V DC	1	Flat
7433	50A	32V DC	1	Restricted-OFF

Part #	Amps	Max.	Poles	Rocker Actuator
7410	10A	32V DC	2	Flat
7411	15A	32V DC	2	Flat
7412	16A	32V DC	2	Flat
7413	20A	32V DC	2	Flat
7574	30A	32V DC	2	Raised
7414	30A	32V DC	2	Flat
7575	32A	32V DC	2	Raised
7415	32A	32V DC	2	Flat
7416	40A	32V DC	2	Flat
7577	50A	32V DC	2	Raised
7417	50A	32V DC	2	Flat

Interrupting Capacity Table (see ABYC Requirements p. 164)

	UL 1077 - UL/CSA (US/Canada)			EN60934 - TUV (Europe)	
	Volts	Amps	DC Interrupt	AC Interrupt	
1 Pole	32V DC	--	5,000A, U2, OL1	--	
	65V DC	--	7,500A, U1, OL1	--	
	125V AC	2-30A	--	3,000A, U2, OL1	--
		40-50A	--	1,500A, U2, OL1	
	250V AC	2-30A	--	1,500A, U2, OL0	1,500A
		40-50A	--	3,000A, U1, OL0	
2 Pole	32V DC	--	5,000A, U2, OL1	--	
	65V DC	--	7,500A, U1, OL1	--	
	125V AC	--	--	3,000A, U2	--
	250V AC	2-30A	--	3,000A, U2, OL1	1,500A
		40-50A	--	3,000A, U2, OL0	

**Related Products**



360 Panel System page 116

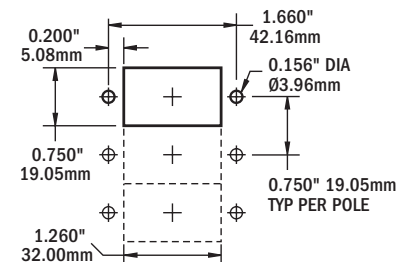
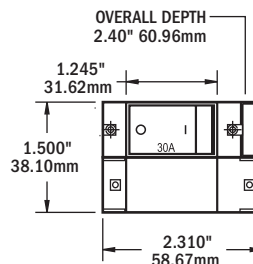
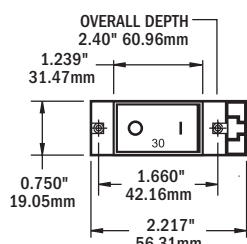

Cutout Dimensions



# C-Series Toggle Circuit Breakers

Combines switching and circuit protection into a single device



### DC Features

- Large frame provides stud termination for 5–300A loads
- Provides overcurrent protection for inverters, bow thrusters, and windlasses
- Offers high interrupt capacity – suitable for Main circuit protection
- Trip Free – cannot be held closed after trip

### AC Features

- Frequently used for 120/240V AC circuit protection
- Double pole can be used as AC Main circuit breaker to switch hot and neutral or two hots in 120/240V AC Branch applications
- Triple pole can be used as 120/240V AC Main circuit breaker to switch both lines (hots) and neutral
- Double and triple pole circuit breakers will trip all poles if any one pole trips

Voltage Nominal Operating	120/240V AC
Temperature Operating	-40°C to 85°C (-40°F to 185°F)
Switching Cycles	10,000 @ rated amps and volts
Type	Magnetic Hydraulic – Trip free
Terminal Stud	1/4"-20 Tin-Plated Brass
Terminal Stud Torque	35 in-lb max.
Trip Time Delay	See <a href="http://blueseas.com">blueseas.com</a>
Mounting Screw	#6-32 Stainless Steel (included)
Mounting Screw Torque	6–8 in-lb Recommended
Regulatory	UL 1077 Recognized & CSA Accepted 7250I only – meets SAE J1171, UL 1500 external ignition protection requirements

**IGNITION PROTECTED**

Interrupting Capacity Table (see ABYC Requirements p. 164)

	UL 1077 - UL/CSA (US/Canada)				EN60934 - TUV (Europe)
	Volts	Amps	DC Interrupt	AC Interrupt	AC Interrupt
1 Pole	48V DC	--	5,000A, U2, OL1	--	--
	85V DC	--	7,500A, U1, OL1	--	--
	125V DC	--	--	3,500A, U2, OL1	--
	250V AC	--	--	3,000A, U2, OL1	--
2 Pole	48V DC	--	5,000A, U2, OL1	--	--
	125V AC	--	--	3,500A, U2, OL1	--
	250V AC	--	--	5,000A, U1, OL1	1,500A

### Related Product



Traditional Metal 7372 page 125

Part #	Color	Amps	Poles	Max.
7350	White	5A DC	1	80V DC
7351	White	10A DC	1	80V DC
7352	White	15A DC	1	80V DC
7353	White	20A DC	1	80V DC
7354	White	25A DC	1	80V DC
7355	White	30A DC	1	80V DC
7244	White	50A DC	1	80V DC
7246	White	60A DC	1	80V DC
7248†	White	80A DC	1	65V DC
7250†	White	100A DC	1	65V DC
7250I†	Red	100A DC	1	48V DC

Part #	Color	Amps	Poles	Max.
7365	White	30A AC	2	80V DC
7251	White	50A AC	2	80V DC
7254	White	60A AC	2	80V DC
7256†	White	80A AC	2	80V DC
7258†	White	100A AC	2	65V DC
7267*†	White	150A DC	2	65V DC
7268*†	White	175A DC	2	65V DC
7269*†	White	200A DC	2	65V DC

Part #	Color	Amps	Poles	Max.
7287	White	50A AC	3	80V DC
7288	White	60A AC	3	80V DC
7289†	White	80A AC	3	80V DC
7290†	White	100A AC	3	80V DC
7270*†	White	250A DC	3	65V DC
7271*†	White	300A DC	3	65V DC

\* Paralleled poles have 5/16" stud on bus. These breakers are not listed and pending UL approval.  
† Only supports motor loads up to 48V DC, UL 1077 OL0

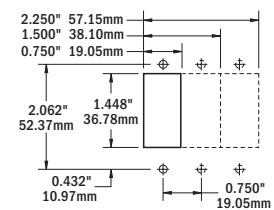
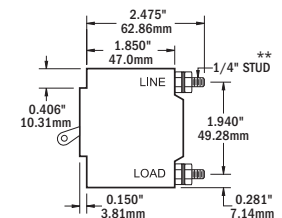
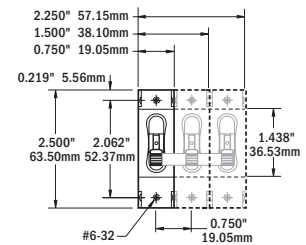

Cutout Dimensions

## C-Series Toggle Circuit Breaker Mounting Panels

Simplifies mounting C-Series Toggle Circuit Breakers

- Accepts Blue Sea Systems Large Format Labels and ON indicating LEDs
- Panel plugs can be inserted to fill blank positions
- Panel Plug Kit 8089 included – circuit breaker mounting screws, panel plug, LED plug and blank label

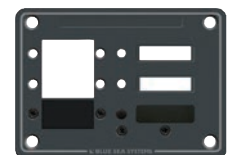

8088

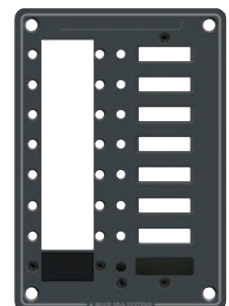

8087

Part #	Description	Width In (mm)	Depth In (mm)
8088	3 position	5.25 (133.35)	3.75 (95.25)
8087	8 position	5.25 (133.35)	7.50 (190.50)
8089	Panel Plug Kit	--	--

# C-Series Rocker Circuit Breakers

Combines switching and circuit protection into a single device



### DC Features

- White actuator indicates OFF position
- Large frame provides stud termination for 5–300A loads
- Flat rocker actuator is flush in the ON position, reducing the risk of accidental switching
- Provides overcurrent protection for inverters, bow thrusters, and windlasses
- Trip Free – cannot be held closed after trip

Voltage Nominal Operating	120/240V AC
Temperature Operating	-40°C to 85°C (-40°F to 185°F)
Switching Cycles	10,000 @ rated amps and volts
Type	Magnetic Hydraulic – Trip free
Terminal Stud	1/4"-20 Tin-Plated Brass
Terminal Stud Torque	35 in-lb max.
Trip Time Delay	See <a href="http://blueseas.com">blueseas.com</a>
Mounting Screw	#6-32 Stainless Steel (included)
Mounting Screw Torque	6–8 in-lb Recommended
Regulatory	Single-pole circuit breakers only – CE marked, meet SAE J1171, UL 1500 and ISO 8846 external ignition protection requirements, CSA certified, and UL 1077 recognized AC Circuit Breakers only – TUV certified, CSA certified, and UL 1077 recognized AC and AC/DC Circuit Breakers only – CE marked

**IGNITION PROTECTED**

Interrupting Capacity Table (see ABYC Requirements p. 164)

	UL 1077 - UL/CSA (US/Canada)				EN60934 - TUV (Europe)
	Volts	Amps	DC Interrupt	AC Interrupt	AC Interrupt
1 Pole	48V DC	--	5,000A, U2, OL1	--	--
	125V DC	--	--	3,500A, U2, OL1	--
	250V AC	5-50A	--	3,500A, U2, OL1	--
		60-100A	--	3,000A, U2, OL0	--
2 Pole	48V DC	--	5,000A, U2, OL1	--	--
	125V AC	--	--	3,500A, U2, OL1	--
	250V AC	--	5,000A, U1, OL1	3,000A, U2, OL0	1,500A

### AC Features

- Used for 120/240V AC circuit protection
- Double pole can be used as AC Main circuit breaker to switch hot and neutral or two hots in 120/240V AC Branch applications
- Triple pole can be used as 120/240V AC Main circuit breaker to switch both lines (hots) and neutral
- Double and triple pole circuit breakers will trip all poles if any one pole trips

Part #	Amps	Max.	Poles	Actuator
7540	5A DC	48V DC	1	Flat
7541	10A DC	48V DC	1	Flat
7542	15A DC	48V DC	1	Flat
7543	20A DC	48V DC	1	Flat
7545	30A DC	48V DC	1	Flat
7546	50A DC	48V DC	1	Flat
7547	60A DC	48V DC	1	Flat
7548	80A DC	48V DC	1	Flat
7549	100A DC	48V DC	1	Flat

Part #	Amps	Max.	Poles	Actuator
7560	30A AC	--	2	Flat
7580	30A AC	--	2	Raised
7561	50A AC	--	2	Flat
7581	50A AC	--	2	Raised
7563	80A AC	--	2	Flat
7583	80A AC	--	2	Raised
7564	100A AC	--	2	Flat
7584	100A AC	--	2	Raised
7475*	150A DC	48V DC	2	Flat
7476*	200A DC	48V DC	2	Flat

Part #	Amps	Max.	Poles	Actuator
7565	50A AC	--	3	Flat
7585	50A AC	--	3	Raised
7568	50A AC	--	3	Flat
7588	100A AC	--	3	Raised
7477*	250A DC	48V DC	3	Flat
7554*	300A DC	48V DC	3	Flat

\* Paralleled poles have 5/16" stud on bus

### Related Product



360 Panel System 1168 page 125

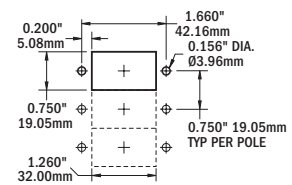
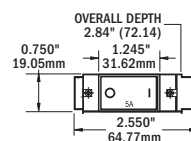
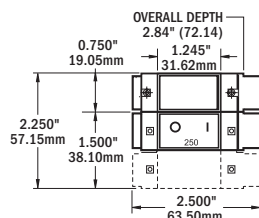

Cutout Dimensions

## TECH TIP

## AC Ground Faults ELCI, the Boater and ABYC

Understanding Equipment Leakage Circuit Interrupters (ELCIs) and Ground Fault Circuit Interrupters (GFCIs) to make your boat safer. There are two potential failures in a boat's electrical system that can put people on or around the boat at risk of lethal electric shock.

In a properly functioning marine electrical system, the same amount of AC current flows in the hot and neutral wires.

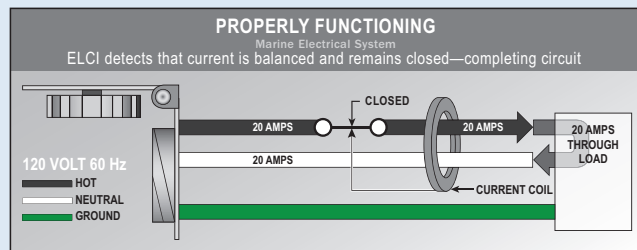

However, if electricity “leaks” from this intended path in these two wires to ground, this condition is called a ground fault. An example of this is an insulation failure in the wiring of an appliance.

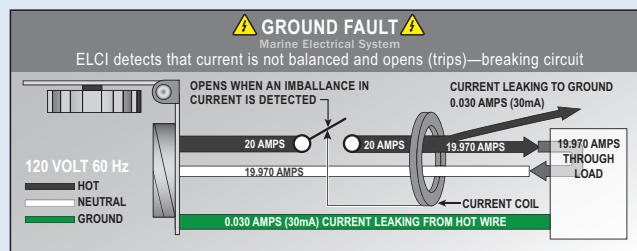

In addition, a faulty ground can occur when the grounding path is broken through a loose connection or broken wire. For instance, a shore power cord ground wire may fail due to constant motion and stress.

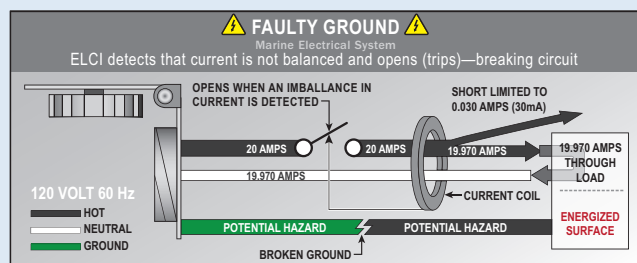

Faulty grounds can be undetectable; a simple continuity test will not necessarily reveal a problem. When these two conditions occur at the same time, the results may be tragic.

The combination of a ground fault and a faulty ground can result in metal parts on the boat and under water becoming energized. If an electric drill with faulty internal wiring or a worn cord falls into the bilge, the water in the bilge will become energized, putting the worker and those nearby at risk.

In addition to the hazard to people on the vessel, there is a larger danger to swimmers near the boat. While people on board are likely to receive a shock from touching energized metal parts, nearby swimmers could receive a paralyzing dose of electricity and drown due to involuntary loss of muscle control.

A Coast Guard sponsored study showed numerous instances of electrical leakage causing drowning or potential drowning even though the shock did not directly cause electrocution.

Given the seriousness of the problem, ABYC requirements now include specific measures for avoiding this danger:

**ABYC E-11.13.3.5 states:**

*If installed in a head, galley, machinery space, or on a weather deck, the receptacle shall be protected by a Type A (nominal 5 milliamperes) Ground Fault Circuit Interrupter (GFCI).*

**ABYC E-11.11.1 states:**

*An Equipment Leakage Circuit Interrupter (ELCI) shall be installed with or in addition to the main shore power disconnect circuit breaker(s) or at the additional overcurrent protection as required by E-11.10.2.8.3 whichever is closer to the shore power connection.*

ELCIs, and the more familiar GFCIs (Ground Fault Circuit Interrupter), are part of a larger family of devices that measure current flow in the hot and neutral wires and immediately switch the electricity off if an imbalance of current flow is detected. ELCIs and GFCIs that are also RCBs (Residual Current Circuit Breaker) provide overcurrent tripping protection characteristic of a normal circuit breaker.

GFCIs are used as branch circuit ground fault protection at the 5mA threshold in potentially wet environments. GFCIs protect against flaws in devices plugged into them, but offer no protection from the danger of a failing hard-wired appliance, such as a water heater or cook top.

In contrast, an ELCI provides additional whole-boat protection. Installed as required within 10' of the shore power inlet, an ELCI provides 30mA ground fault protection for the entire AC shore power system beyond the ELCI. ABYC regulations still require the use of GFCIs in environments described above.

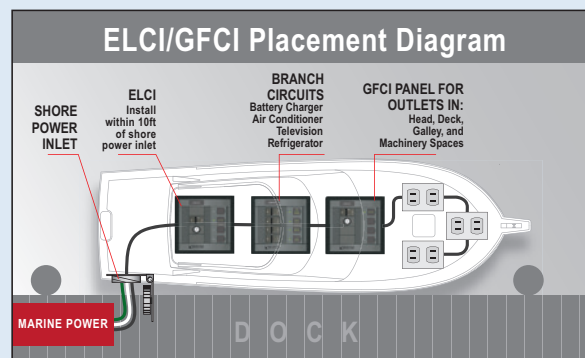

Although ABYC regulations apply only to new boat construction, ELCIs can mitigate dangers and liabilities that exist for any boat owner with a shore power connection. Retrofitting an ELCI to an existing AC system can be a worthwhile safeguard against risk. Since an ELCI/RCBO can serve as the main shore power circuit breaker, it can replace a standard circuit breaker in this application.

Alternatively, an ELCI/RCBO can be added between the shore power inlet and the existing main shore power circuit breaker. Safety ground system failures on boats are safety and liability disasters waiting to happen. ELCI protection on each shore power line, combined with protection afforded by GFCIs, will reduce risk to those on the boat, the dock, and in the water surrounding the boat.

\*The ABYC has an exemption to this rule if an isolation transformer is used. See E-11 for specific information regarding the exemption.



# Residual Current Circuit Breakers

## Equipment Circuit Interrupter (ELCI) Main

Residual Current Devices (RCDs) respond to leakage of electrical current outside of the intended circuit path

When the RCD function is combined with a circuit breaker for over current protection, the device is often referred to as an RCBO. In the USA, a device that trips on leakages of nominally 5mA and meets certain standards is called a Ground Fault Circuit Interrupter (GFCI). A device meeting the same standards but with a trip level of 30mA is called an Equipment Leakage Circuit Interrupter (ELCI). The devices below provide ELCI Main functions and circuit protection in panel mounted breakers.

- Trips on short circuit, overload, or leakage to ground
- For installation in a power distribution panel
- Provides overcurrent and leakage protection per ABYC E-11 for whole boat shore power protection

Part #	3102100, 3104, 3093	3091, 3092, 3103, 3106100
Interrupting Capacity	5,000A AC - UL 1077 U2	3,000A AC - UL 1077 U2
Temperature Operating	-35°C to 66°C (-31°F to 150°F)	-35°C to 66°C (-31°F to 150°F)
Switching Cycles	10,000 @ rated amps and volts	10,000 @ rated amps and volts
Type	Magnetic Hydraulic - Trip free	Magnetic Hydraulic - Trip free
Mounting Screw	#6-32 Stainless Steel (included)	#6-32 Stainless Steel (included)
Mounting Screw Torque	6-8 in-lb Recommended	6-8 in-lb Recommended
Regulatory	UL 1077, UL 943 Class A	UL 1077, UL 943 Class A

**IGNITION PROTECTED**

Part #	Description	Frame Series	Nominal Voltage	Actuator	Poles	AC Main Amps	Leakage Trip Amps
3102100	ELCI Main	A-Series	120V AC per pole	Flat Rocker	2	30A	30mA
3103**	ELCI Main	C-Series	120V AC per pole	Flat Rocker	2	50A	30mA
3104	ELCI Main	C-Series	120/240V AC per pole	Flat Rocker	3	50A	30mA
3106100**	ELCI Main	A-Series	120V AC per pole	White Toggle	2	30A	30mA
3091**	ELCI Main	C-Series	230V AC per pole*	Flat Rocker	2	16A	30mA
3092**	ELCI Main	C-Series	230V AC per pole*	Flat Rocker	2	32A	30mA
3093	ELCI Main	C-Series	240V AC per pole†	Flat Rocker	2	50A	30mA

\* 230V AC, Typical of Europe  
 \*\* Interrupting Capacity of 3000 A AC  
 † 240V AC, For isolation transformer applications



3102100



3103, 3091, 3092, 3093



3104



3106100

Related Products



AC GFCI Dual Outlets  
page 152, 153



SMS Surface Mount System  
page 88



Residual Current Circuit Breaker  
ELCI Main Panels  
page 126

## SMS Surface Mount System Panel Enclosure

Panel enclosure for ELCI Main circuit breakers and other large frame devices. Meets ABYC E-11 when used with an ELCI Main circuit breaker and mounted within 10 feet of the shore power inlet

- Blank apertures for custom breaker loading
- Clear cover allows easy view of circuit breaker status
- Blank circuit positions accommodate Carling Technologies™ A and C Series Flat Rocker and ELCI Main circuit breakers
- Stainless steel mounting hardware included

Enclosure Size	6.0" x 6.0" x 4.0" 152 mm x 152 mm x 102 mm
Exterior Overall Dimensions	7.6" x 7.4" x 4.7" 192 mm x 188 mm x 120 mm
Temperature Range	-40°C to 85°C (-40°F to 185°F) *
Cover Screws and Hardware	10-32 stainless steel
Mounting Hardware	Ø 1/4", #12, (6 mm)
Regulatory	IP66 – Protected against powerful water jets when cover is latched (see inside back cover) Flammability rating – Per UL 508, Toxicity – Non-toxic, halogen free, RoHS compliant, UL Listed and NEMA 4X rated, NEMA Type 4, 4X, 6, 6P, 12, and 13

\* Temperature range for SMS Enclosures with ELCI Main breakers installed: -35°C to 66°C (-31°F to 150°F)

Interrupting Capacity Table (see ABYC Requirements p. 164)



**3120** NOTE: SMS panel enclosures are pre-assembled and ready for wire connections. Customers must select wire and entry or exit locations, drill holes, and install the appropriate glands.



Part #	3113	3116	3121	3117
Description	6 blank positions	ELCI Main + 3 blank positions	ELCI Main + 2 blank positions	120V AC ELCI 30A Dual
Circuit Breakers	---	1 × ELCI Main 120V, 30A, 30mA (3102)	1 × ELCI Main 230V, 16A, 30mA (3091)	2 × ELCI Main 120V 30A, 30mA (3102)
Glands Included	---	2 × (3124) 3 × (3125)		2 × (3124) 4 × (3125)
LEDs Installed	---	4 × green ON 120V AC (8034) 3 × green ON 120V AC (8034) 1 × red Reverse Polarity 120V AC (8066)		2 × green ON indicating 120V AC (8034) 2 × red Reverse Polarity 120V AC (8066)
Labels Included	30 Basic DC (4205) 30 Basic AC (4206) Panel Voltage ID	1 × AC Main, 1 Reverse Polarity 1 × ELCI, 30 Basic AC (4206) Panel Voltage ID		Source Selection label Set - 10 labels 2 × Reverse Polarity, 2 ELCI Panel Voltage ID



Part #	3118	3123	3119	3120
Total Positions	ELCI Main + 2 blank positions		ELCI Main + 1 blank position	ELCI Main + 2 blank positions
Circuit Breakers	1 × ELCI Main 120V 50A, 30mA (3103)	1 × ELCI Main 230V 32A, 30mA (3092)	1 × ELCI Main 120/240V, 50A, 30mA (3104)	1 × ELCI Main 240V, 50A, 30mA (3093)
Glands Included	2 × (3124) 1 × (3125)	2 × (3126)	2 × (3124) 1 × (3125) 2 × (3126)	2 × (3124) 1 × (3125) 2 × (3126)
LEDs Installed	3 × green ON indicating 120V AC (8034) 1 × red "Reverse Polarity" 120V AC (8066)		3 × green ON indicating 120V AC (8034) 1 × red Reverse Polarity 120V AC (8066)	2 × green ON indicating 240V AC (6806)
Labels Included	1 × AC Main, 1 Reverse Polarity 1 × ELCI, 30 Basic AC (4206) Panel Voltage ID		1 × AC Main, 1 Reverse Polarity 1 × ELCI, 30 Basic AC (4206) Panel Voltage ID	1 × AC Main, 1 ELCI Panel Voltage ID



Part #	3122	3128	3130
Description	ELCI Main + 2 branch positions	ELCI Main + 3 branch positions	UL 489 AC Main + 4 branch positions
Circuit Breakers	1 x ELCI Main 230V, 16A, 30mA (3091) 2 x Branch, 8A (7401)	1 x ELCI Main 120V, 30A, 30mA (3102) 3 x Branch, 15A (7403)	1 x Main 120V, 50A (7467) 3 x Branch, 15A (7456)
Glands Included	2 x (3124) 3 x (3125)	2 x (3124) 3 x (3125)	2 x (3124) 3 x (3125)
LEDs Installed	3 x green ON indicating 230V AC (8134) 1 x red Reverse Polarity 230V AC (8166)	4 x green ON indicating 230V AC (8134) 1 x red Reverse Polarity 230V AC (8166)	5 x green ON indicating 120V AC (8034) 1 x red Reverse Polarity 120V AC (8066)
Labels Included	1 x AC Main, 1 Reverse Polarity 1 x ELCI, 30 Basic AC (4206) Panel Voltage ID	1 x AC Main, 1 Reverse Polarity 1 x ELCI, 30 Basic AC (4206) Panel Voltage ID	1 x AC Main, 1 Reverse Polarity 1 x 30 Basic AC (4206) Panel Voltage ID



Part #	3133	3134	3135
Total Positions	DC Main + 5 branch positions	DC 6 branch positions	UL 489 DC Main + 5 branch positions
Circuit Breakers	1 x Main 12/24V DC, 100A (7549) 3 x Branch 12/24V DC, 15A (7403)	4 x Branch 12/24V DC, 15A (7403)	1 x Main 12/24V DC, 100A (7446) 3 x Branch 12/24V DC, 15A (7442)
Glands Included	2 x (3124) 2 x (3125) 1 x (3126)	2 x (3124) 2 x (3125) 1 x (3126)	2 x (3124) 2 x (3125) 1 x (3126)
LEDs Installed	6 x amber ON indicating 12/24V DC (8033)	6 x amber ON indicating 12/24V DC (8033)	6 x amber ON indicating 12/24V DC (8033)
Labels Included	1 x DC Main 30 Basic DC (4218) Panel Voltage ID 12V and 24V DC	30 Basic DC (4218) Panel Voltage ID 12V and 24V DC	30 Basic DC (4218) Panel Voltage ID 12V and 24V DC

## SMS Surface Mount System Panel Enclosure Glands

Used on the SMS Surface Mount System Panel Enclosures



Part #	3124	3125	3126
Description	Small Gland PG7	Medium Gland PG16	Large Gland PG29
Wire Size	#14 to #10 Single Wire	#14 to #10 Cable, 3 Conductor	#6 Cable, 4 Conductor
Cable Dia. Minimum	.114 in (2.9 mm)	.230 in (2.9 mm)	.590 in (15.0 mm)
Cable Dia. Maximum	.250 in (6.4 mm)	.530 in (2.9 mm)	.990 in (25.4 mm)
Dimensions in (mm)	A. Clearance Hole .492 (12.5) B. Max. O. A. Length 1.17 (29.7) C. Wrenching Flats .59 (15.0)	A. Clearance Hole .886 (22.5) B. Max. O. A. Length 1.66 (42.2) C. Wrenching Flats 1.05 in (26.7)	A. Clearance Hole 1.47 (37.3) B. Max. O. A. Length 2.23 (56.6) C. Wrenching Flats 1.66 (42.2)

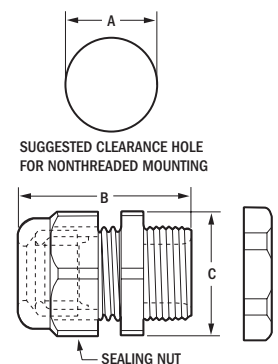

### Related Products



UL-489  
Circuit Breakers  
page 81

Circuit Breaker  
Enclosure  
page 82

A-Series Rocker  
Circuit Breakers  
page 83

C-Series Rocker  
Circuit Breakers  
page 85

ELCI  
Circuit Breakers  
page 87



# Circuit Breaker Specification Table

## DC Thermal Circuit Breakers



Page #	75	76	76	77	78	79
Product	Push Button Reset-Only	Medium Duty Push Button Reset-Only	Short Stop	ATO/ATC-Style Low Profile	285-Series	187-Series
Interrupting Capacity	3,000A @ 14.7V DC 2,500A @ 28V DC	5,000A @ 32V DC 3,000A @ 120V AC	2,500A @ 28V DC	2,000A @ 28V DC	3,000A @ 48V DC†	5,000A @ 14V DC 3,000A @ 28V DC 1,500A @ 48V DC
Max. Voltage	32V DC	32V DC / 120V AC	28V DC	32V DC	48V DC	48V DC
Amperages	3-40A	15-60A	5-50A	5-30A	25-150A	25-200A
Regulatory	EN 60934, CE marked, UL 1077, TUV certified, UL 1500, ISO 8846	SAE J553, UL 1077, UL 1500	SAE J553, SAE J1171, IP64	SAE J553, SAE J1171	CE marked, SAE J1171, IP67	CE marked, SAE J1171, IP66

† AIC ratings achieved using SAE J1625

## AC/DC A-Series Circuit Breakers



Page #	82	83	83	82	83	83
Product	A-Series Toggle	A-Series Flat Rocker	A-Series Restricted Off Rocker	A-Series Toggle	A-Series Flat Rocker	A-Series Raised Rocker
Interrupting Capacity DC	5,000A @ 32V DC, U2 7,500A @ 65V DC, U1	5,000A @ 32V DC, U2 7,500A @ 65V DC, U1		5,000A @ 32V DC, U2 7,500A @ 65V DC, U1	5,000A @ 32V DC, U2 7,500A @ 65V DC, U1	
Interrupting Capacity AC	2,000A @ 125V AC, U2 1,500A @ 250V AC, TUV	(2A-30A) 3,000A @ 125V AC, U2 (40A-50A) 1,500A @ 125V AC, U2 1,500A @ 250V AC, TUV		3,000A @ 125V AC, U2 1,500A @ 250V AC, TUV	3,000A @ 125V AC, U2 1,500A @ 250V AC, TUV	
Max. Voltage DC	65V DC	65V DC		65V DC	65V DC	
Max. Voltage AC	250V AC					250V AC
Poles	1			2		
Amperages	2.5-50A	2.5-50A	5-50A	10-50A		
Regulatory	CE marked, TUV certified, CSA certified, UL 1077					

## AC/DC Military Grade and C-Series Circuit Breakers



Page #	80	81	81	84	84	85
Product Style	COTS Water Resistant	AC UL-489 Rocker	DC UL-489 Rocker	C-Series Toggle	C-Series Toggle	C-Series Flat Rocker
Interrupting Capacity DC	5,000A @ 32V DC, U2 7,500A @ 65V DC, U1	--	10,000A @ 80V DC	5,000A @ 48V DC, U2 7,500A @ 48V DC, U1	5,000A @ 48V DC, U2 7,500A @ 48V DC, U1	5,000A @ 48V DC, U2 5,000A @ 65V DC, U1
Interrupting Capacity AC	2,000A @ 125V AC, U2 5,000A @ 250V AC, U1	5,000A @ 240V AC	--	3,500A @ 125V AC, U2 3,000A @ 250V AC, U2	3,500A @ 125V AC, U2 3,000A @ 250V AC, U2	3,500A @ 125V AC, U2 3,000A @ 250V AC, U2
Max. Voltage DC	65V DC	--	80V DC	48-80V DC		48-80V DC
Max. Voltage AC	--	250V AC	--	250V AC		250V AC
Poles	2	1 & 2	--	1		
Amperages	5-50A	5-50A	5-100A	5-100A	100A	5-100A
Regulatory	UL 1077, CSA certified	UL 489, CSA certified, TUV certified		--	SAE J1171, UL 1500, ISO 8846	CE marked, SAE J1171, UL 1500, ISO 8846, CSA certified, UL 1077

### DC C-Series Circuit Breakers



Page #	84	85	84	85
Product Style	C-Series Toggle	C-Series Flat Rocker	C-Series Toggle	C-Series Flat Rocker
Interrupting Capacity	5,000A @ 48V DC, U2 5,000A @ 65V DC, U1	5,000A @ 48V DC, U2	5,000A @ 48V DC, U2 5,000A @ 65V DC, U1	5,000A @ 48V DC, U2
Max. Voltage	65V DC	48V DC	65V DC	48V DC
Poles	2		3	
Amperages	150-200A		250-300A	
Regulatory	--	--	--	--

### AC C-Series Circuit Breakers



Page #	84	85	85	84	85	85
Product Style	C-Series Toggle	C-Series Raised Rocker	C-Series Flat Rocker	C-Series Toggle	C-Series Raised Rocker	C-Series Flat Rocker
Interrupting Capacity	3,500A @125V AC, U2 3,000A @250V AC, U2	3,500A @125V AC, U2 3,000A @250V AC, U2		3,500A @125V AC, U2 3,000A @250V AC, U2	3,500A @125V AC, U2 3,000A @250V AC, U2	
Max. Voltage	250V AC	250V AC		250V AC	250V AC	
Poles	2			3		
Amperages	30-100A			50-100A		
Regulatory	--	CE marked, TUV certified, CSA certified, UL 1077			--	CE marked, TUV certified, CSA certified, UL 1077

### AC ELCI Main Circuit Breakers



Page #	87	87	87	87	3091* (87)	3092* (87)	3093† (87)
Product	ELCI Main	ELCI Main	ELCI Main	ELCI Main	ELCI Main		
Interrupting Capacity	5,000A, U2	3,000A, U2	3,000A, U2	5,000A, U2	3,000A, U2	3,000A, U2	5,000A, U2
Nominal Voltage				120/240V per pole	230V per pole		240V per pole
Amperage	30A		50A	50A	16A	32A	50A
Leakage Trip Amps	30mA			30mA	30mA		
Regulatory	UL 1077, UL 943 Class A						

\* 230V AC, Typical of Europe

† 240V AC, For isolation transformer applications

## Water-Resistant Contura Switches

Specifically manufactured for use in Blue Sea Systems Contura Water-Resistant Panels



Use of non Blue Sea Systems Contura Switches will not maintain the water resistant ingress protection rating of Blue Sea Systems panels.

- Vibration, shock, thermoshock, moisture and salt spray resistant
- Mounts in Blue Sea Systems Contura Water Resistant Panels (p. 114) and Contura Switch Mounting Panels (p. 94)

Amperage Max. Operating	20A @ 12V DC, 15A @ 24V DC
Amperage Operating Current	18 Milliamps
Lighted	LED rated 100,000 hours half-life
Seals	Internal and external gasket panel seal
Temperature Rating	-40°C (-40°F) to 85°C (185°F)
Mounting Hole	1.45 in x 0.83 in (36.83 mm x 21.08 mm)
Regulatory	CE marked, meets UL 1500 and ISO 8846 external ignition protection requirements

**IGNITION PROTECTED**

Part # Contura II Black	Part # Contura III Gray	Part # Contura III Black	Actuator Position to Light LED	Pole Throw	Action	LEDs
7929	8230	8282	ON	SPST	OFF-ON	1
7930	8231	8292	--	SPST	OFF-(ON)	0
7931	8232	8283	ON	SPDT	ON-OFF-ON	2
7932	8233	8284	ON	SPDT	(ON)-OFF-ON	1
7933	8234	8285	--	SPDT	(ON)-OFF-(ON)	0
7943	7944	7945	(ON)	SPDT	(ON)-OFF-ON	1
7934	8218	8287	ON	DPST	OFF-ON	1
7935	8219	8288	--	DPST	OFF-(ON)	0
7936	8220	8286	ON	DPDT	ON-OFF-ON	2
7937	8221	8289	ON	DPDT	(ON)-OFF-ON	1
7938	8222	8290	--	DPDT	(ON)-OFF-(ON)	0
7939	8275	8300	ON	DPDT	ON-ON	2

See p. 97 for common applications

( ) = Momentary

## Water-Resistant Contura Dimmer and m-LVD Switches



- Mounts in Blue Sea Systems Contura Water-Resistant Panels (p. 114) and Contura Switch Mounting Panels (p. 96)
- Dimmer Switch Legend – BRIGHT and DIM
- m-LVD Switch Legend–OVERRIDE and OFF
- Ignition protected – safe for installation aboard gasoline powered boats

Amperage Max. Operating	20A @ 12V DC, 15A @ 24V DC
Pole, Throw	SPDT
Action	(ON)-OFF-(ON)
Terminal Size	0.25 in (6.35 mm)
Terminal Type	Quick Connect Tab
Seals	Internal and external gasket panel seal
Temperature Rating	-40°C (-40°F) to 85°C (185°F)
Mounting Hole	1.45 in x 0.83 in (36.83 mm x 21.08 mm)
Regulatory	CE marked

Part #	For Use With:	LEDs
8216	DeckHand Dimmer (p. 27)	--
8291	DeckHand Dimmer (p. 27)	--
7928	m-LVD Low Voltage Disconnect (p. 40)	1

See p. 97 for common applications

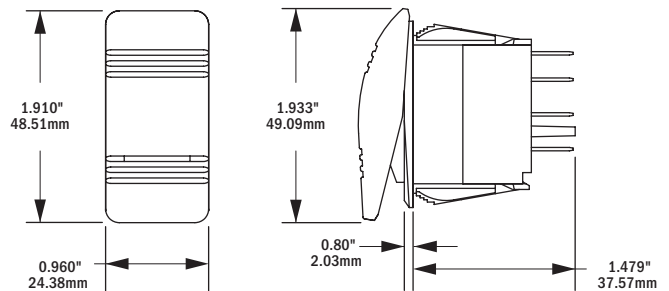

### Related Products

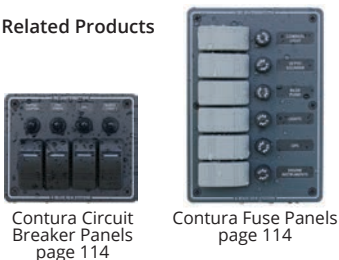

Contura Circuit Breaker Panels page 114

Contura Fuse Panels page 114

### Related Products



DeckHand Dimmers page 27

m-LVD page 40



## Remote Control Contura Switches

Provide remote switching of ML-Series Products



2145, 2155

2146

- Vibration, shock, thermoshock, moisture and salt spray resistant
- Lockout slide reduces the risk of accidental switching 2145 and 2155

Amperage Max. Operating	20A @ 12V DC, 15A @ 24V DC
Amperage Operating Current	18mA
Temperature Range	-40°C (-40°F) to 85°C (185°F)
Pole/Throw	SPDT
Lighting	LED rated 100,000 hours half-life
Seals	Internal and external gasket panel seal
Mounting Hole	1.45" x 0.83" (36.83 mm x 21.08 mm)
Regulatory	Meets UL 1500 and ISO 8846 external ignition protection requirements, IP67 – protected against immersion up to 1 meter for 30 minutes (see inside back cover)

**IGNITION PROTECTED**

Part #	For Use With:	Pole Throw	Action
2145	ML-Series 7700, 7702, (p. 43) 7701, 7703, (p. 40)	SPDT	(ON)-OFF-(ON)
2146	ML-Series 7620, 7622, 7621, 7623 (p. 51)	SPDT	ON-OFF-ON
2155	ML-Series 7713, 7717 (p. 43)	SPDT	ON-ON

See p. 97 for common applications

( ) = Momentary

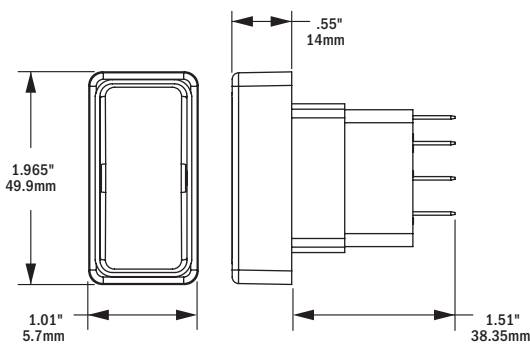

### Related Products



ML-Series RBS page 43

ML-Series ACR page 51

## Contura Switch Mounting Panel Plug

Covers Contura Switch mounting hole for future switch installation



- For use with Contura Switch Mounting Panels

Part #	Description
8278	Contura Switch Mounting Panel Plug

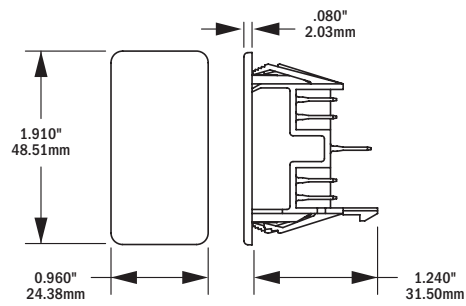

### Related Products



Contura Switch Mounting Panels page 94

## Contura Switch Actuators

Replaces actuators on Blue Sea Systems Contura Water-Resistant Panels



8297

8294

8293

- Mounts on any Blue Sea Systems Water Resistant Contura Switch

Part # Gray	Part # Black	Lenses
8299	8296	--
8297	8294	1
8298	8295	2
8293	Actuator Removal Tool	

## Remote Control Switch 360 Panels

Use with ML-Series Remote Battery Switches or Automatic Charging Relays

- Backlit labels
- Lockout slides
- Square format label set 4218 (p. 154)



1147 Switches: 2145 (2); 2146 (1)  
24V DC Max.



1148 Switches: 2145 (3)  
24V DC Max.

Part #	Description	Width in (mm)	Height in (mm)	Depth in (mm)
1147	2 RBS and 1 ACR	4.88 (123.83)	4.75 (120.65)	2.00 (50.80)
1148	3 RBS	4.88 (123.83)	4.75 (120.65)	2.00 (50.80)
1520	3 Blank Apertures	4.88 (123.83)	4.75 (120.65)	0.125 (3.175)

## Contura Switch Mounting Panels

Modular design permits assembly in groups



8267



8266



8268

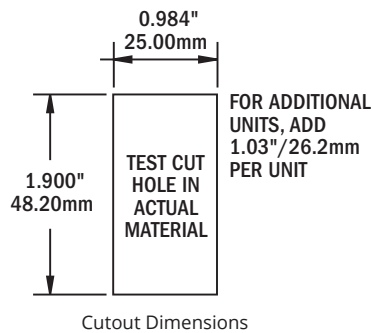

- Mounting panels available in 1, 3, and 6 fixed position models
- Designed for mounting in 6 different panel thicknesses:  
0.06 in (1.57 mm) 0.09 in (2.36 mm) 0.13 in (3.17 mm)  
0.19 in (4.75 mm) 0.25 in (6.35 mm) 0.38 in (9.52 mm)

Part #	Description	Width in (mm)	Height in (mm)
8267	End Mounting Panel	1.19 (30.23)	2.30 (58.42)
8266	Center Mounting Panel	1.03 (26.16)	2.30 (58.42)
8268	1 Position Mounting Panel	1.34 (34.04)	2.30 (58.42)
8259	3 Position Mounting Panel	3.40 (86.36)	2.30 (58.42)
8260	6 Position Mounting Panel	6.49 (164.85)	2.30 (58.42)

## Dual Bilge Pump 360 Panel

Controls two bilge pumps with restricted-off circuit breakers and manual override switches

- Controls two bilge pumps
- Restricted-OFF circuit breakers provide 24-hour circuit protection to the bilge pump float switch
- On-indicating LED indicates power is available at the bilge pump float switch
- Manual override switch with on-indicating LED provides visual indication pump is running; also illuminates when pump is running as a result of float switch operation



Part #	Description	Width in (mm)	Height in (mm)
1522	Dual Bilge Pump Control Panel	4.88 (123.83)	4.75 (120.65)

## 360 Panel Rocker Switches

Provides switching options for different configurations

Amperage Max. Operating	See table below
Single Pole Connections	0.187 in (4.80 mm) Quick Connect Tabs
Double Pole Connections	6.00 in (152.00 mm) Wire Leads

Part #	Pole/Throw	Image	Action	Amps Max. Operating			
				DC 12V	DC 24V	AC 125V	AC 250V
7480	SPST	1	OFF-ON	10A	10A	10A	10A
7481	SPST	1	OFF-(ON)	10A	10A	12A	6A
7482	SPDT	2	ON-OFF-ON	10A	8A	8A	8A
7483	SPDT	2	(ON)-OFF-ON	10A	8A	8A	8A
7484	SPDT	2	(ON)-OFF-(ON)	10A	8A	8A	8A
7485	SPDT	4	(ON)-OFF-(ON)	10A	8A	8A	8A
7490	DPST	1	OFF-ON	5A	5A	8A	4A
7491	DPST	3	ON-ON	5A	5A	8A	4A
7492	DPDT	2	ON-OFF-ON	5A	5A	8A	4A
7493	DPDT	3	ON-(ON)	5A	5A	8A	4A
7494	DPDT	2	(ON)-OFF-ON	5A	5A	8A	4A
7495	DPDT	2	(ON)-OFF-(ON)	5A	5A	8A	4A

See p. 97 for common applications

( ) = Momentary



### Recommended Panel Opening

PANEL THICKNESS	A	B
.030" (.76mm)-.050" (1.27mm)	.508" (12.90mm)	.756" (19.20mm)
.050" (1.27mm)-.078" (1.98mm)	.508" (12.90mm)	.764" (19.40mm)
.078" (1.98mm)-.125" (3.17mm)	.508" (12.90mm)	.780" (19.81mm)

+0.00 [-0.00]-.004 [-.10]

TEST CUT HOLE IN ACTUAL MATERIAL

## Push Button Switches

Contemporary and compact 10A, 15A, & 20A switching

- Two push button illumination options to choose from - backlit and LED ring
- 316 Stainless Steel for optimal appearance and corrosion resistance
- IP67 waterproof with O-ring panel gasket and molded rear cover
- Reverse polarity protected

Part #	4160, 4161, 4162, 4163
Amperage Max. Operating	10A @ 12V DC
Voltage Nominal	12V DC
Max. LED Operating Current	20mA
Switching Cycles	40,000
Temperature Range	-10°C to 70°C (14°F to 158°F)
Termination	5 - 0.110" Quick Connect tabs terminals included
Wire Size	--
Panel Thickness	.04" -.31" (1-8mm)
Mounting Hole Diameter	3/4" (19mm)
Regulatory	ISO 8846, SAEJ1171, UL 1500. IP67 - protected against immersion up to 1 meter for 30 minutes (see inside back cover)

Part #	4180 & 4181
Amperage Max. Operating	15A @ 12V DC
Voltage Nominal	12V DC
Max. LED Operating Current	20mA
Switching Cycles	10,000
Temperature Range	-20°C to 55°C (-4°F to 131°F)
Termination	3" Bare Pigtails
Wire Size	8-16 AWG
Panel Thickness	.04" -.24" (1-6mm)
Mounting Hole Diameter	7/8" (22.35mm)
Regulatory	IP67 - protected against immersion up to 1 meter for 30 minutes (see inside back cover)



5 ICON labels included

## Push Button Switch Label Kit

ICON Labels used on Backlit Push Button Switches

- Scratch resistant polycarbonate material
- Back printed for durability
- Waterproof adhesive for longevity in wet environments
- Can be ordered individually (p. 154)



Part #	Description	Quantity
4230	Icon Label Kit	50 labels

## 10A LED Ring Push Button Switches



Part #	LED	Action
4160	Blue	OFF-ON
4161	Blue	OFF-(ON)
4162	Red	OFF-ON
4163	Red	OFF-(ON)

See p. 97 for common applications ( ) = Momentary

## 15A Backlit Push Button Switches

- Backlit button is blue when OFF and red when ON
- Five ICON labels included: Accessory, Lights, Anchor Light, Running Light, and Bilge Pump
- Additional 50 ICON label kit sold separately



Part #	LED	Action
4180	Blue / Red	OFF-ON
4181	Blue / Red	OFF-(ON)

See p. 97 for common applications ( ) = Momentary

### Related Products



Individual Round Icon Labels page 154



## WeatherDeck® Toggle Switches

For use in WeatherDeck Waterproof Panels



4150-4154

4155

- Manufactured for use in WeatherDeck Waterproof Panels (p. 115)
- Nickel-plated brass and phenolic non-corrosive construction

Part #	4150-4154	4155
Amperage Max. Operating	10A @ 250V AC 15A @ 125V AC 15A @ 12V DC	5A @ 30V DC
Voltage Max. Operating	250V AC	30V DC
Terminal Size	0.25 in (6.35 mm)	0.25 in (6.35 mm)
Terminal Type	Quick Connect Tab	Quick Connect Tab

Part #	Pole/Throw	Action ( ) = Momentary
4150	SPST	OFF-ON
4151	SPST	OFF-(ON)
4152	SPDT	ON-OFF-ON
4153	SPDT	(ON)-OFF-ON
4154	SPDT	(ON)-OFF-(ON)
4155	DPDT	ON-OFF-ON

( ) = Momentary

## WeatherDeck® Toggle Switch Boot

Replaces boot on WeatherDeck Waterproof Panels



- For mounting on WeatherDeck Toggle Switches above
- UV resistant material resists discoloration and cracking
- Rated IP67 – protected against immersion up to 1 meter for 30 minutes (See inside back cover)

Part #	4138
Thread Material	Nickel Plated Brass
Thread	15/32"-32UNS-2A

### Related Products



WeatherDeck Panels  
page 115

## Panel Switches

Mounts in an A-Series toggle circuit breaker aperture to provide multiple throw and switch configurations when circuit protection is provided elsewhere



8204

8200

- Ideal for generator starters, bilge pumps, horns, wipers, engine controls and other applications that require switching action other than ON-OFF or different pole configuration separate from circuit protection
- For use with A-Series Toggle Circuit Breaker Mounting Panel (p. 82)
- Supplied with mounting adapter for standard 5/8" circuit breaker mounting hole
- Nickel-plated brass and phenolic non-corrosive construction

	Toggle	Push Button
Amperage Max. Operating	10A @ 250V AC 15A @ 125V AC 15A @ 32V DC	3A @ 250V AC 6A @ 125V AC 6A @ 32V DC
Terminal Size	0.25 in (6.35 mm)	0.25 in (6.35 mm)
Terminal Type	Quick Connect Tab	Quick Connect Tab
Actuator Color	White	White

Part #	Actuator	Pole/Throw	Action ( ) = Momentary
8200	Push Button	SPST	OFF-(ON)
8204	Toggle	SPST	OFF-ON
8205	Toggle	SPST	OFF-(ON)
8206	Toggle	SPDT	ON-OFF-ON
8207	Toggle	SPDT	(ON)-OFF-ON
8208	Toggle	SPDT	(ON)-OFF-(ON)
8209	Toggle	DPST*	OFF-ON-(ON) / OFF-OFF-(ON)
8210	Toggle	DPST	OFF-ON
8211	Toggle	DPDT	ON-OFF-ON
8212	Toggle	DPDT	(ON)-OFF-ON

\* Progressive two circuit switch - maintains Circuit 1 while momentarily switching Circuit 2

( ) = Momentary

## 360 Panel Adapters and Plugs

Adapters allow mounting alternative switches and circuit breakers in the flat rocker aperture. Plugs fill empty flat rocker apertures.



4111

4112

4119

4116

4117

Part #	Description
4111	Adapts Push Button Reset-Only Circuit Breaker (p. 75)
4112	Adapts A-Series Toggle Circuit Breaker (p. 82) and Panel Switch
4119	Adapts 360 Panel Rocker Switch (p. 94)
4116	Panel Plug fills flat rocker circuit breaker aperture
4117	Panel Plug fills 360 Panel Rocker Switch aperture
8037	Panel Plugs fill Toggle Circuit Breaker aperture (6 pack)

# Switch Comparison

**SPST** Turns a single circuit on and off.  
**SPDT** Turns one of two circuits on.  
**DPST** Turns two circuits on at the same time.  
**DPDT** Turns one circuit in each of 2 pairs of circuits.



Switch Type	Action	Common Applications	Contura II Black p. 92	Contura III Gray p. 92	Contura III Black p. 92	Contura ML Control p. 93	360 Panel Rockers p. 94	LED Ring Push-Button p. 95	Backlit Push-Button p. 95	WeatherDeck® Toggle p. 96	Panel Switch p. 96	Panel Switch p. 96
SPST 	Off-On	Lights	7929	8230	8282	-	7480	4160 4162	4180	4150	--	8204
SPST 	Off-(On)	Horn or Windshield wipers	7930	8231	8292	-	7481	4161 4163	4181	4151	8200	8205
SPDT 	On-Off-On	Combining nav lights or anchor light with independent bulbs	7931	8232	8283	2146	7482	--	--	4152	--	8206
SPDT 	(On)-Off-On	Windshield wipers LED - (ON)	7932	8233	8284	--	7483	--	--	4153	--	8207
		Bilge pumps LED - (ON)	7943	7944	7945	--	--	--	--	--	--	--
SPDT 	On-On	Control switch for SafetyHub 250 and ML-Series RBS 7712 and 7714	--	--	--	2155	--	--	--	--	--	--
SPDT 	(On)-Off-(On)	Intermittent wiper, Trim tabs, Control switch for ML-Series RBS except 7712 and 7714	7933	8234	8285	2145	7484 7485	--	--	4154	--	8208
DPST 	Off-On	Navigational lights	7934	8218	8287	--	7490	--	--	--	--	8210
DPST 	Off-(On)	Wipers or horn	7935	8219	8288	--	--	--	--	--	--	--
DPST 	Off-On-(On) Off-Off-(On)	Combining nav lights and anchor lights with shared switch	--	--	--	--	--	--	--	--	--	8209
DPDT 	On-Off-On	Combining nav lights with anchor light with shared bulb	7936	8220	8286	--	7492	--	--	4155	--	8211
DPDT 	(On)-Off-(On)	Dual wipers	7937	8221	8289	--	7494	--	--	--	--	8212
DPDT 	(On)-Off-(On)	Power operated hatches	7938	8222	8290	--	7495	--	--	--	--	--
DPDT 	On-(On)	Bilge pump with 2 circuits	--	--	--	--	7493	--	--	--	--	--
DPDT 	On-On	Switching between shunts or current transformers with one meter	7939	8275	8300	--	7491	--	--	--	--	--

( ) = Momentary   ● Center Terminal Switch Lever   ● Terminal   ○ Off Position

# CONNECTORS & INSULATORS

## Water-Resistant 100A BusBar



100

Provides secure water-resistant bussing for harsh environments.

## Common BusBars

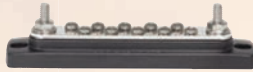

100

BusBars distribute positive wires or collect negative returns. BusBars range in capacity from 100A to 600A.

## Terminal Blocks



103

Terminal blocks allow termination of wires from a multi-conductor cable in one location. Individual wires can then be split off to various loads.

## PowerBars



104

Complex wiring systems require a single point to consolidate large and small conductors.





# CONNECTORS & INSULATORS

## PowerPost Connectors



106

Insulated single stainless steel stud terminates multiple large conductors, or collects small wires with tin-plated copper bus.

## Terminal Feed Through Connectors



106

Eliminates chafe and provides strain relief when passing high current through hulls, decks, and bulkheads.

## CableCaps



109

Provides insulation for multiple types of battery posts.

## CableClams



109

Provides a waterproof pass-through for antenna cables without requiring removal of the factory installed connector.



**Connectors and BusBars are the backbone of every electrical system and safely keep current flowing.**

Blue Sea Systems' connectors and busbars reduce heat and improve efficiency and reliability in a boat or vehicle's electrical system.

## Water-Resistant - 100A BusBar

Provides secure water-resistant bussing for harsh environments.

- Water-resistant IP66 design
- Accepts standard ring or fork type terminals to allow for simple wiring with standard tools.
- Accepts a wide range of wire sizes
- Integral plugs maintain water-resistant rating if less than four loads are required
- Nests with Water-Resistant 100A Common BusBar (2356 or 2356100) and ST-Blade Water-Resistant Fuse Block (5056 or 5056100)
- Ideal for positive distribution or for the collection of DC negative or AC grounding conductors
- Tin-plated copper busses
- Includes four write-on circuit labels
- Small format standard and custom labels available

Continuous Rating	100A AC / 100A DC
Voltage Max. Operating	300V AC / 48V DC
Input Wire Size	(1) 8 AWG to 4 AWG
Load Wire Size	(4) 16 AWG to 10 AWG
Mounting Holes	Accepts 1/4" (6mm) Screws
Bus Material	Tin-Plated Copper C11000
Regulatory	CE & UKCA certified, for an ABYC/USCG compliant design use (2356100) CE marked, IP66 - protected against powerful water jets (see inside back cover)

Part #	Cover	Terminal Screws	Terminal Studs
2356	Screw Cover	4 × #8-32	1 × #10-32
2356100	Manual Cover	4 × #8-32	1 × #10-32

For dimensioned drawings see page 62



2356100

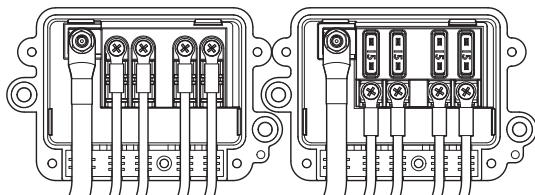

Nested ST-Blade Water-Resistant Fuse Block 5056 and Water-Resistant - 100A BusBar 2356

## MiniBus - 100A Common BusBars

Provides bussing for limited space applications

- One-piece serrated flange nut ensures correct and secure connections

Continuous Rating	100A AC / 100A DC
Voltage Max. Operating	300V AC / 48V DC
Mounting Holes	Accepts #10 (M5) Screws
Bus Material	Tin-Plated Copper C11000
Regulatory	CE & UKCA certified

Part #	Cover	Terminal Screws	Terminal Studs
2304	--	5 × #8-32	2 × #10-32
2314	Yes	5 × #8-32	2 × #10-32
2305	--	--	4 × #10-32
2315	Yes	--	4 × #10-32
2306	--	6 × #8-32	--
2713	Cover For MiniBus 2304 and 2305		



2314 with cover  
2304 without cover



2315 with cover  
2305 without cover



2306 is DC only rated.  
Mounting holes accept #8 screws

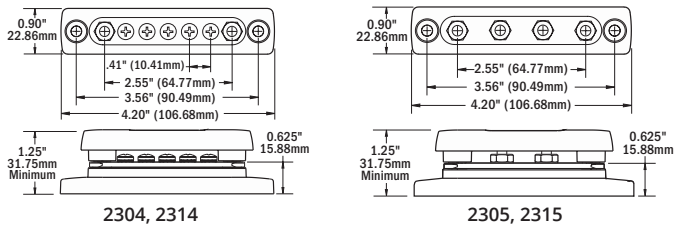

2304, 2314

2305, 2315

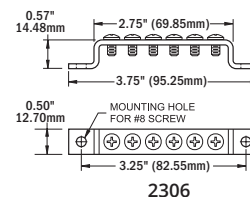

2306

### Related Products



ST-Blade Water-Resistant Fuse Block page 62



## DualBus - 100A Common BusBars

Combines two buses on one block

- Combines negative and positive buses for DC Systems and neutral and ground buses for AC Systems

Continuous Rating	100A AC / 100A DC
Voltage Max. Operating	300V AC / 48V DC
Bus Material	Tin-Plated Copper C11000
Regulatory	CE & UKCA certified

Part #	Cover	Terminal Screws	Mounting Holes
2701	--	5 per bus × #8-32	Accept #10 (M5) Screws
2702	--	10 per bus × #8-32	Accept #10 (M5) Screws
2709	Cover for 2701		
2710	Cover for 2702		



2701



2709

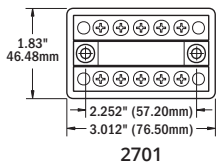

2701

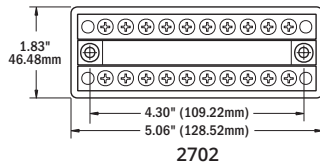

2702

## DualBus Plus - 150A Common BusBars

Secure, clear polycarbonate cover snaps on easily to meet ABYC insulation requirements

- Combines negative and positive buses on one block
- Cover release buttons
- One-piece stainless flange nuts ensure safe and secure connections

Continuous Rating	130A AC / 150A DC
Voltage Max. Operating	300V AC / 48V DC
Mounting Holes	Accept #10 (M5) Screws
Bus Material	Tin-Plated Copper C11000
Regulatory	CE & UKCA certified

Part #	Terminal Screws	Terminal Studs
2722	5 per bus × #10-32	2 per bus × 1/4"-20 Stud
2723	5 per bus × #10-32	2 per bus × 5/16"-18 Stud



2722

## 150A Common BusBars

Insert-molded stainless steel studs eliminate the need for securing nuts and allow high torquing for excellent electrical contact

- For positive distribution and for the collection of negative or AC ground circuits
- One-piece serrated flange nut ensures correct and secure connections

Continuous Rating	130A AC / 150A DC
Voltage Max. Operating	300V AC / 48V DC
Mounting Holes	Accepts #10 (M5) Screws
Bus Material	Tin-Plated Copper C11000
Regulatory	CE & UKCA certified

Part #	Cover	Terminal Screw	Terminal Stud
2301	--	10 × #8-32	2 × 1/4"-20
2300	Yes	10 × #8-32	2 × 1/4"-20
2302	--	20 × #8-32	2 × 1/4"-20
2312	Yes	20 × #8-32	2 × 1/4"-20
2303	--	--	4 × 1/4"-20
2307	Yes	--	4 × 1/4"-20
2715	Cover 2301 and 2303		
2716	Cover for 2302		

Note: 2715 replaces 2706, 2716 replaces 2707



2300 with cover  
2301 without cover



2307 with cover  
2303 without cover



2312 with cover  
2302 without cover



## MaxiBus -250A Common BusBars

Insert-molded stainless steel studs and optional fully enclosed insulating base and cover

- Insulating cover with breakouts for easy wire access
- Insulating cover meets ABYC insulation requirements
- One-piece serrated flange nuts ensure correct and secure connections

Continuous Rating	250A AC / 250A DC
Voltage Max. Operating	300V AC / 48V DC
Mounting Hardware	#10 (M5) Screws
Bus Material	Tin-Plated Copper C11000
Regulatory	CE & UKCA certified



2128



2105



2127



2126

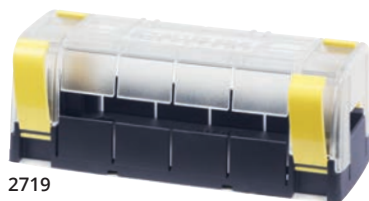

2719



2718

Part #	Terminal Studs	Terminal Screws	[A] Length in (mm)	[B] Mounting Centers in (mm)
2105	2 × 5/16" -18	12 × #10-24	7.75 (197.00)	7.125 (181.00)
2126	6 × 5/16" -18	-	7.75 (197.00)	7.125 (181.00)
2718	Cover for 2105 and 2126	-	8.78 (223.10)	5.41 (137.30)
2127	4 × 5/16" -18	-	5.875 (149.00)	5.25 (133.00)
2128	2 × 5/16" -18	6 × #10-24	5.875 (149.00)	5.25 (133.00)
2719	Cover for 2127 and 2128	-	6.70 (170.00)	4.10 (104.10)

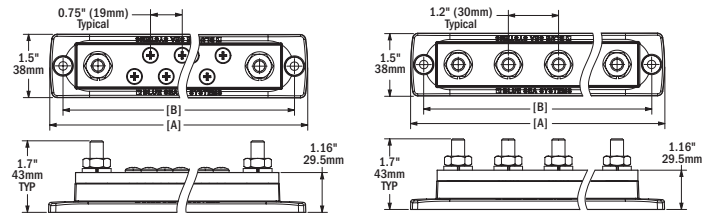

2128, 2105

2127, 2126

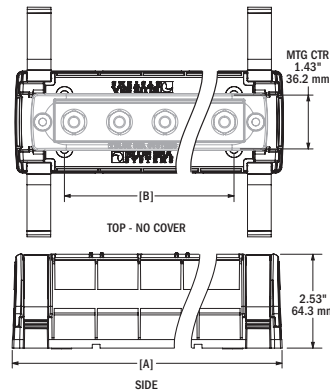

2719 and 2718

## PowerBar Common BusBars

Provides compact high-amp busing with 3/8" terminal studs



2019

Continuous Rating	up to 200A
Voltage Max. Operating	48V DC
Mounting Holes	Accepts #10 (M5) Screws
Bus Material	Tin-Plated Copper C11000
Regulatory	CE & UKCA certified

Part #	Terminal Studs	Insulators
2019	2 × 3 / 8" -16	Yes
2020	2 × 3 / 8" -16	--

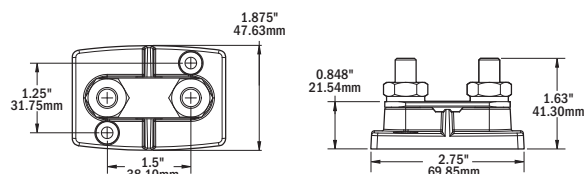

### 2719 Related Products



285 Series Circuit Breakers 7180-7189 page 78



DC Shunts page 149

### 2718 Related Product



PowerBar 600A Common BusBar 2104 page 104

## Terminal Blocks

### Fully insulated independent terminal blocks

- Each screw pair is one isolated circuit
- Terminal Block Jumpers allow creation of common circuits
- Closed back design insulates power from the mounting surface

<b>Bus Material</b>	Nickel-Plated Brass
<b>Base Material</b>	High temp UL 94 VO thermoplastics
<b>Regulatory</b>	RoHS and UL Recognized, CE & UKCA certified



2406

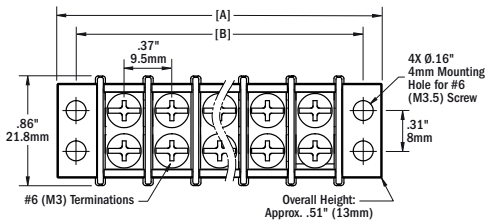

2402-2410



2506

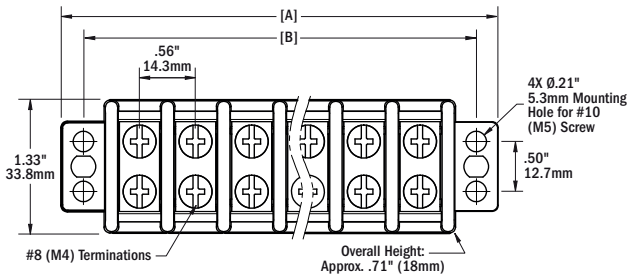

2502-2512



2606

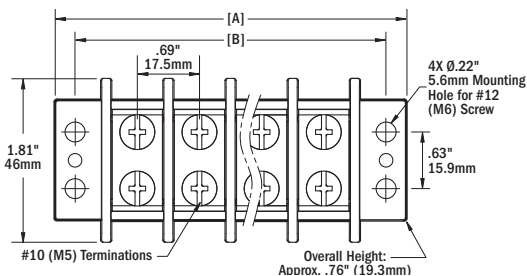

2602-2610

Part #	Circuits	AC/DC Amps	AC/DC Volts	Terminal Screw	[A] Length in (mm)	[B] Mounting Centers in (mm)
2402	2	20A	300V	M3.5 (#6)	1.43 (36.20)	1.13 (28.70)
2404	4	20A	300V	M3.5 (#6)	2.17 (55.00)	1.87 (47.60)
2406	6	20A	300V	M3.5 (#6)	2.91 (74.00)	2.62 (66.60)
2408	8	20A	300V	M3.5 (#6)	3.66 (93.00)	3.37 (85.60)
2410	10	20A	300V	M3.5 (#6)	4.41 (112.00)	4.12 (104.60)
2502	2	30A	600V	M4 (#8)	2.13 (54.00)	1.69 (42.80)
2504	4	30A	600V	M4 (#8)	3.25 (82.60)	2.81 (71.40)
2506	6	30A	600V	M4 (#8)	4.38 (111.20)	3.94 (100.00)
2508	8	30A	600V	M4 (#8)	5.50 (139.70)	5.06 (128.50)
2510	10	30A	600V	M4 (#8)	6.63 (168.30)	6.18 (157.10)
2512	12	30A	600V	M4 (#8)	7.75 (196.80)	7.31 (185.60)
2602	2	65A	600V	M5 (#10)	2.51 (63.80)	2.06 (52.40)
2604	4	65A	600V	M5 (#10)	3.89 (98.70)	3.44 (87.30)
2606	6	65A	600V	M5 (#10)	5.26 (133.60)	4.81 (122.20)
2608	8	65A	600V	M5 (#10)	6.63(168.50)	6.19 (157.10)
2610	10	65A	600V	M5 (#10)	8.01 (203.40)	7.56 (192.00)

## Terminal Block Jumpers

Combines independent circuits on Terminal Blocks and ST-Blade Fuse Blocks 5035 and 5037

<b>Bus Material</b>	Nickel-Plated Brass
<b>Continuous Amperage</b>	Equivalent to matching block

Part #	Description	Retail Pack
9218	For use with 20A Terminal Blocks	5
9217	For use with 30A Terminal Blocks and ST-Blade Fuse Blocks 5035 & 5037	5
9216	For use with 65A Terminal Blocks	5



### Related Product



ST-Blade Fuse Blocks page 64

## TECH TIP

### Connector & Insulators Explained

**Tin-plated copper buses** provide maximum conductivity and corrosion resistance.

**Insert-molded stainless steel studs** eliminate the need for securing nuts and allow high torquing for excellent electrical contact.

**UL 94-V0 rated** UL 94-V0 rated base materials have flame retardants and will self extinguish if a flame source is removed.

**Terminal Screws** incorporate stainless steel split ring lock washers and captive star-type lock washers keep connections tight in high vibration environments.

**One-Piece Serrated Flange Nuts** ensure correct and secure connections which do not cause resistance.

**Insulating covers** meet ABYC and USCG insulation requirements.

## PowerBar - 600A Common BusBars

High amperage BusBar with 3/8" terminal studs

Continuous Rating	545A AC / 600A DC
Voltage Max. Operating	300V AC / 48V DC
Mounting Hardware	#10 (M5) Screws
Bus Material	Tin-Plated Copper C11000
Regulatory	CE & UKCA certified

Part #	Terminal Studs	Terminal Screws	[A] Length in (mm)	[B] Mounting Centers in (mm)
2104	4 x 3/8" -16	4 x #8-32	7.0 (177.8)	6.25 (158.74)
2107	8 x 3/8" -16	4 x #8-32	11.375 (288.93)	10.375 (263.53)
2708	Cover For 2104			



2104



2107

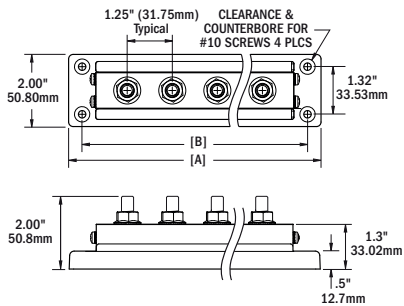

2708



### Related Products



MaxiBus Cover 2718  
page 102

## PowerBar 1000 - 1000A Common BusBars

Provides a single point to consolidate large and small conductors

- For large complex wiring systems
- Tin-plated pure electrical copper for maximum conductivity
- Stepped bus design offers two elevations for conductors which doubles the density of the wire loom compared to traditional bus bars
- Busbar and fuse block elevations match common fuse blocks allowing for multiple fuse block attachment, eliminating the need for connecting cables
- One-piece serrated flange nuts ensure correct and secure connections
- Stainless steel 8-32 screws with captive lock washers for securing smaller gauge wires
- Busbar may be cut to a shorter length to accommodate constricted spaces
- Bi-directional busbar end caps allow the ganging of additional busbars
- Snap on insulating cover meets ABYC and USCG requirements and includes label recess
- Models available to accommodate either 3/8" or 5/16" terminals

Continuous Rating	1000A
Voltage Max. Operating	150V AC / 48V DC
Mounting Hardware	#10 (M5) Screws
Bus Material	Tin-Plated Copper C11000

Part #	Cover	Terminal Studs	Terminal Screws
1990	Yes	8 x 3/8"-16	5 x #10-32, 11 x #8-32
1991	Yes	12 x 3/8"-16	5 x #10-32, 11 x #8-32
1992	Yes	8 x 5/16"-18	5 x #10-32, 11 x #8-32
1993	Yes	12 x 5/16"-18	5 x #10-32, 11 x #8-32
2730B	PowerBar 1990 & 1992 Cover	--	--
2731B	PowerBar 1991 & 1993 Cover	--	--



1990



1991

### Related Products



Terminal (MRBF)  
Fuse Block  
page 68



ANL Fuse Block  
page 69



Safety AMI/MIDI  
Fuse Block  
page 70



## TECH TIP

### PowerBar 1000 Explained

The PowerBar 1000 offers mounting and application flexibility. Coupled with security features like serrated flange nuts and an insulating cover, the PowerBar 1000 is an organized and secure termination point for the boat or vehicle's critical electrical connections.

PowerBar 1000 used as a grounding bus and high density collecting point for both large and small gauge conductors.

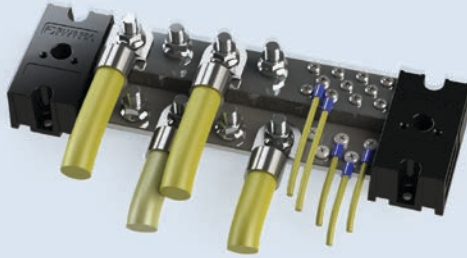

PowerBar 1000 used as a high amperage positive distribution bus for various types and sizes of fuses as well as high density collecting point for both large and small gauge conductors. Typically this configuration would include the snap on insulating cover but pictured without to better show fuse blocks.

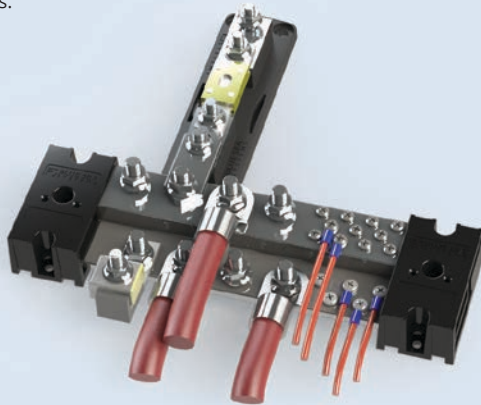

PowerBar 1000 used as a positive distribution bus and high density collecting point for both large and small gauge conductors. Pictured with snap on insulating cover.

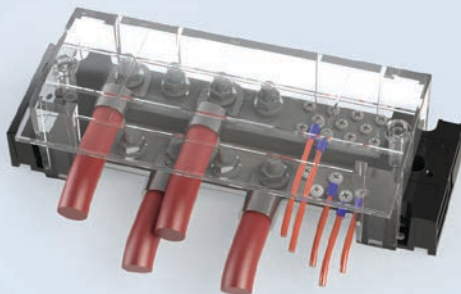

#### Gang two or more PowerBars together



## Battery Terminal Mount BusBars

Easily add positive and negative busbars to a threaded-post battery terminal

- Tin-plated pure electrical copper for maximum conductivity
- Insulating covers meet ABYC/USCG insulation requirements
- Screw terminals for securing wires
- 2340 Includes four 16-14 AWG and four 12-10 AWG Nylon Insulated ring terminals

Continuous Rating	100A DC
Voltage Max. Operating	32V DC
Bus Material	Tin-Plated Copper C11000
Mounting Thru-hole	Clearance for 3/8" (M10) stud
Screw Terminal	#8-32 Screws with Captive Star Lock washer

Part #	Description
2340	Positive + Negative
2341B	Positive
2342B	Negative

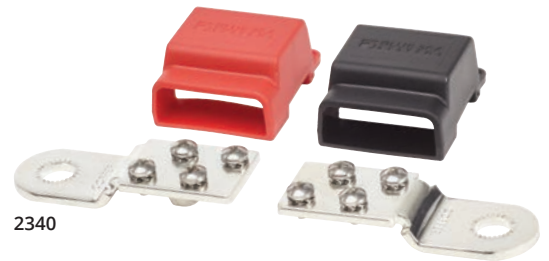

2340

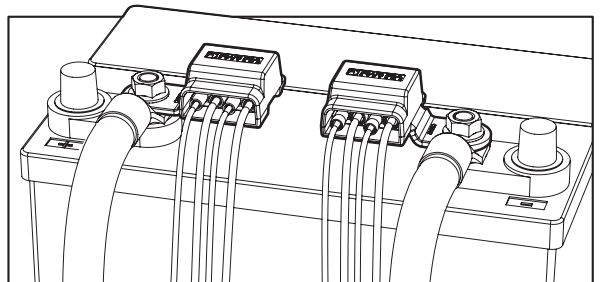

#### Related Products



ST-Blade Battery Terminal Mount Fuse Block Kit page 63

### PowerPost Cable Connectors

Insulated single stainless steel stud terminates multiple large conductors



- One-piece serrated flange nuts ensure correct and secure connections

<b>Continuous Rating</b>	Not rated - stacked on post and is determined by wire and terminals used.
<b>Voltage Max. Operating</b>	48V DC
<b>Mounting Hardware</b>	#8 Screws (2010, 2011) 1/4" Screws (2001, 2002, 2003)
<b>Regulatory</b>	CE & UKCA certified

Part #	Terminal Stud
2010	#10-32 x 5/8"
2011	1/4"-20 x 3/4"
2001	1/4"-20 x 1-1/16"
2002	5/16"-18 x 7/8"
2003	3/8"-16 x 7/8"

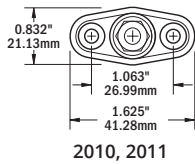
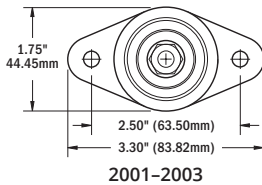

### PowerPost Plus Cable Connectors

Enables connection of multiple smaller wires in spaces where a traditional bus bar may not fit

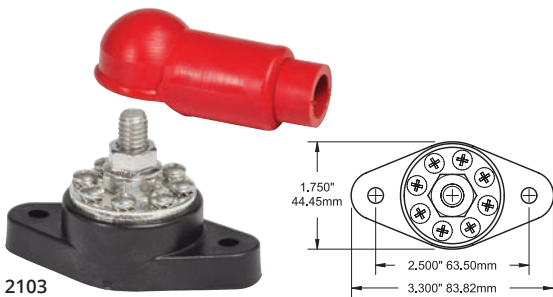

- Allows small wire connections at high amperage cable connections
- One-piece serrated flange nut ensures correct and secure connections

<b>Continuous Rating</b>	150A DC
<b>Voltage Max. Operating</b>	48V DC
<b>Mounting Hardware</b>	1/4" Screws
<b>Bus Material</b>	Tin-Plated Copper
<b>Regulatory</b>	CE & UKCA certified

Part #	Terminal Stud	Terminal Screws
2101	1/4"-20 x 1"	8 x #8-32
2102	5/16"-18 x 3/4"	8 x #8-32
2103	3/8"-16 x 3/4"	8 x #8-32

### Dual PowerPost Cable Connectors

Provides a termination point for extending the length of outboard harnesses or other conductors

- Designed for connecting high amperage conductors
- 2018 is also designed for outboard engine installation when factory cables need to be extended
- One-piece serrated flange nuts ensure correct and secure connections

<b>Continuous Rating</b>	Not rated - amperage flows between terminals stacked on post and is determined by wire and terminals used.
<b>Voltage Max. Operating</b>	48V DC
<b>Mounting Hardware</b>	#10 (M5) Screws
<b>Regulatory</b>	CE & UKCA certified



Part #	Terminal Studs	Insulating Cover	Stud Height A in (mm)	Stud Height B in (mm)
2016	2 x 5/16"-18	Yes	1.50 (38.1)	1.50 (38.1)
2017	2 x 3/8"-16	Yes	1.63 (41.3)	1.63 (41.3)
2017100B	2 x 3/8"-16	--	1.63 (41.3)	1.63 (41.3)
2018	1 x 5/16"-18, 1 x 3/8"-16	Yes	1.50 (38.1)	1.63 (41.3)

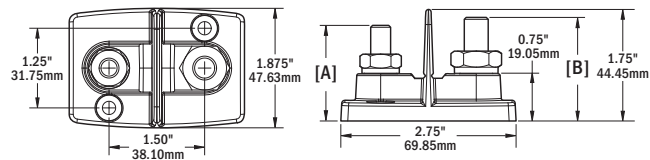

### Terminal Feed Through Connectors

Eliminates chafe and provides strain relief when passing high current through hulls, decks and bulkheads

- Protects large cables that are subject to chafing when passed through holes
- The large terminals have a mounting face that can be gasketed or bedded to provide a water-tight installation
- One-piece serrated flange nut ensures correct and secure connections

<b>Stud Material</b>	Tin-Plated Copper Alloy
<b>Mounting Hardware</b>	#10 (M5) Screws
<b>Regulatory</b>	Rated IP66 - protected against powerful water jets



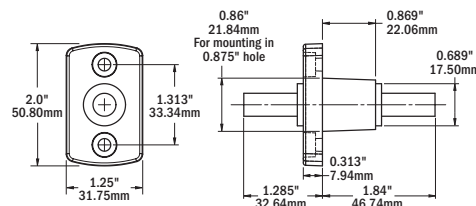



Part #	Terminal Stud	Amps	Volts	Color
2201	5/16"-18	250A	48V	Black
2202	5/16"-18	250A	48V	Red
2203	3/8"-16	250A	48V	Black
2204	3/8"-16	250A	48V	Red















2201





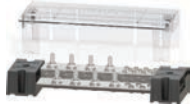

2202

# Connector Comparison

							
Part #	2356 & 2356100	2304 & 2314	2305 & 2315	2306	2340	2701 & 2702	2722 & 2723
Page #	100	100			105	101	101
Product	Water-Resistant 100A BusBar	MiniBus 100A Common BusBars			Battery Mount BusBars	DualBus 100A Common BusBars	DualBus Plus 150A Common BusBars
Continuous	100A AC / 100A DC	100A AC / 100A DC			100A DC	100A AC / 100A DC	130A AC / 150A DC
Max. Voltage	300V AC / 48V DC	300V AC / 48V DC			32V DC	300V AC / 48V DC	300V AC / 48V DC
Terminal Screw	4 x #8-32	5 x #8-32	--	6 x #8-32	4 per bus x #8-32	2701: 5 per bus x #8-32 2702: 10 per bus x #8-32	5 per bus x #8-32
Terminal Stud	--	2 x #10-32	4 x #10-32	--	--	--	2 per bus x 1/4"-20 or 2 per bus x 5/16"-18
Insulating Cover	Included	Cover available			Included	Cover available	Included

							
Part #	2300 & 2301	2312 & 2302	2307 & 2303	2128	2105	2127	2126
Page #	101			102			
Product	150A Common BusBars			MaxiBus 250A Common BusBars			
Continuous	130A AC / 150A DC			250A AC / 250A DC			
Max. Voltage	300V AC / 48V DC			300V AC / 48V DC			
Terminal Screw	10 x #8-32	20 x #8-32	--	6 x #10-24	12 x #10-24	--	--
Terminal Stud	2 x 1/4"-20		4 x 1/4"-20	2 x 5/16"-18	2 x 5/16"-18	4 x 5/16"-18	6 x 5/16"-18
Insulating Cover	Cover available			Cover available			

						
Part #	2019	24XX	25XX	26XX	1992 & 1993	1990 & 1991
Page #	102	103			104	
Product	PowerBar Common BusBar	Terminal Blocks			PowerBar 1000A	
Continuous	Determined by wire up to 200A	20A AC / 20A DC	30A AC / 30A DC	65A AC / 65A DC	1000A	
Max. Voltage	48V DC	300V AC / 300V DC	600V AC / 600V DC	600V AC / 600V DC	150V AC / 48V DC	
Terminal Screw	--	#6	#8	#10	5 x #10-24, 11 x #8-32	5 x #10-24, 11 x #8-32
Terminal Stud	2 x 3/8"-16	--	--	--	8 x 5/16"-8 or 12 x 5/16"-8	8 x 3/8"-8 or 12 x 3/8"-8
Insulating Cover	Included	--	--	--	Included	

							
Part #	2104	2107	2201-2204	2010 & 2011	2001-2003	2101-2103	2016-2018
Page #	104		106	106		106	106
Product	PowerBar 600A Common BusBars		Terminal Feed Through Connectors	PowerPost Cable Connectors		PowerPost Plus	Dual PowerPost
Continuous	545A AC / 600A DC		250A DC	Determined by wire and terminals		150A DC	Determined by wire and terminals
Max. Voltage	300V AC / 48V DC		48V DC	48V DC		48V DC	48V DC
Terminal Screw	4 x #8-32		--	--		8 x #8-32	--
Terminal Stud	4 x 3/8"-16	8 x 3/8"-16	5/16"-18 or 3/8"-16	1 x #10-32 or 1 x 1/4"-20	1 x 1/4"-20 or 1 x 5/16"-18 or 1 x 3/8"-16	1 x 1/4"-20 or 1 x 5/16"-18 or 1 x 3/8"-16	2 x 5/16"-18 or 2 x 3/8"-16 or 1 x 5/16"-18 and 1 x 3/8"-16
Insulating Cover	Cover available	--	--	Included		Included	Included



### Stud Mount Insulating Boots

Insulates conductive posts and studs

- Press-fit design for all 5/16" (M8) and 3/8" (M10) posts and studs
- Ideal for ML-Series Remote Battery Switches, Solenoids & Automatic Charging Relays, battery terminals, power posts, bus bars, battery switches, and much more.
- For use with insulated ring terminals and lugs only

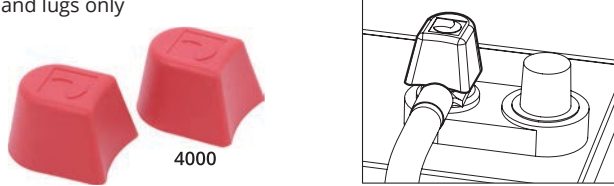

Part #	Cable Size (AWG)	Color	Package
4000	All	Red	Retail/2

### Rotating CableCap Insulators

Insulates battery terminals which have integral wing nut posts

- Top rotates 360 degrees to allow cable entry from any angle

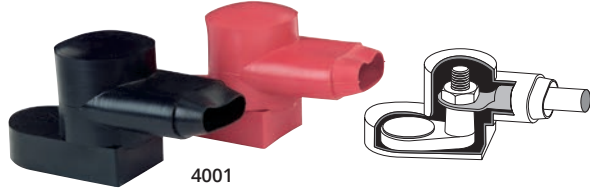

Part #	Cable Size (AWG)	Color	Package
4001	All	Red/Black	Pair/Retail
9030B	All	Black	Bulk/Not for retail
9031B	All	Red	Bulk/Not for retail

### Standard CableCap Insulators

Insulates battery terminals which have added adapter terminals

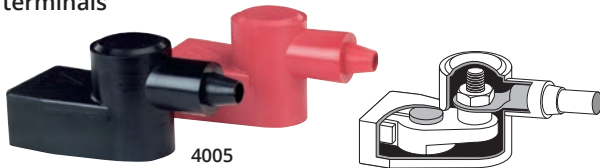

Part #	Cable Size (AWG)	Color	Package
4005	4, 2, 1	Red/Black	Pair/Retail
4006	1/0, 2/0	Red/Black	Pair/Retail
9038B	4, 2, 1	Black	Bulk/Not for retail
9039B	4, 2, 1	Red	Bulk/Not for retail
9040B	1/0, 2/0	Black	Bulk/Not for retail
9041B	1/0, 2/0	Red	Bulk/Not for retail

### Automotive CableCap Insulators

Insulates battery terminals which have standard automotive posts



Part #	Cable Size (AWG)	Color	Package
4016	4, 2, 1	Red/Black	Pair/Retail
4017	1/0, 2/0	Red/Black	Pair/Retail
9176B	1/0, 2/0	Red	Bulk/Not for retail
9177B	1/0, 2/0	Black	Bulk/Not for retail

### Square CableCap Insulators

Insulates battery terminals which have in-line dual posts



Part #	Cable Size (AWG)	Color	Package
4018	1/0	Red/Black	Pair/Retail
4019B	1/0	Red	Bulk/Not for retail
4020B	1/0	Black	Bulk/Not for retail

### Stud CableCap Insulators

Insulates single stud on alternators, starters, windlasses and high amperage termination points

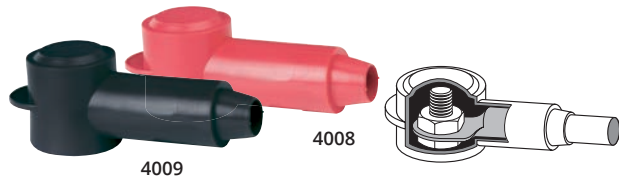

Part #	Cable Size (AWG)	Color	Package
4008	18-10	Red	Retail/3
4009	18-10	Black	Retail/3
4010	8-4	Red	Retail/2
4011	8-4	Black	Retail/2
4012	2-2/0	Red	Retail/1
4013	2-2/0	Black	Retail/1
4014	3/0-4/0	Red	Retail/1
4015	3/0-4/0	Black	Retail/1

### PowerPost Insulator

Insulates single studs and large cables

- Included with 2001, 2002, 2003, 2101, 2102, 2103, and 2019



Part #	Cable Size (AWG)	Color	Package
4004	up to 2/0	Red	Retail

### Dual Entry PowerPost Cable Insulators

Protects against accidental short circuits

- For use with Dual PowerPost Cable Connectors (p. 106)

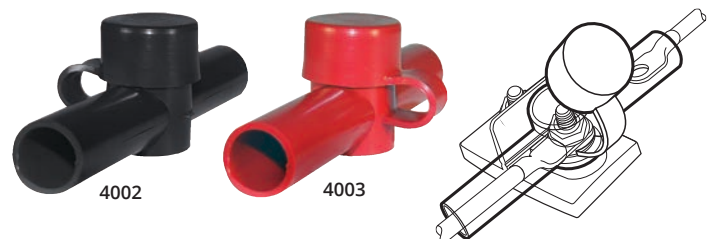

Part #	Cable Size (AWG)	Cable Entry Size in (mm)	Color	Package
4002	up to 2/0	0.7 (17.8)	Black	Retail/1
4003	up to 2/0	0.7 (17.8)	Red	Retail/1

### CableClams

Provides a waterproof pass-through for antenna cables without requiring removal of the factory installed connector



1001

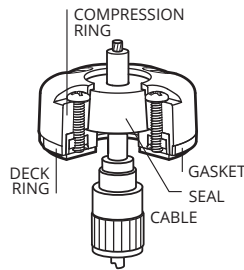

1001100

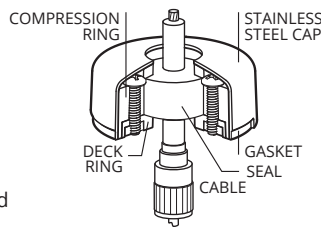

- Save the expense of removing and replacing connectors
- Avoid poor connections from removing factory connectors
- Use 1001, 1001100 for GPS cables, 1002, 1002100 for VHF cables, 1003, 1003100 for Radar cables
- 1001100, 1002100, 1003100 includes pre-drilled and slit rubber seals for easier installation
- 1001100, 1002100, 1003100 includes a 316 stainless steel dress cap which conceals mounting hardware and matches other deck hardware
- Stainless steel fasteners included

Ring Material	UV-Stabilized Thermoplastic
Seal Material	UV-Stabilized Buna-N Rubber

Part #	Seals Included	Max. Connector Diameter in (mm)	Max. Cable Diameter in (mm)	Stainless Steel Cap	Mounting Holes Accept
1001	--	0.68 (17.0)	0.31 (8.0)	--	#6 x 7/8" screws
1001100	3	0.68 (17.0)	0.31 (8.0)	Yes	#6 x 7/8" screws
1002	--	0.83 (21.0)	0.44 (11.0)	--	#8 x 7/8" screws
1002100	3	0.83 (21.0)	0.44 (11.0)	Yes	#8 x 7/8" screws
1003	--	1.40 (35.0)	0.56 (14.0)	--	#8 x 7/8" screws
1003100	1	1.40 (35.0)	0.56 (14.0)	Yes	#8 x 7/8" screws

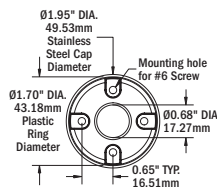

1001 / 1001100

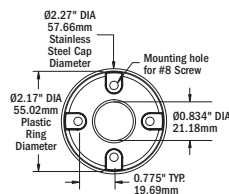

1002 / 1002100

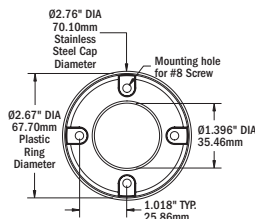

1003 / 1003100

### Side-Entry CableClams with Stainless Steel Dress Cap

Provides a water-resistant side-entry for cables without requiring removal of the factory installed connector



1007100

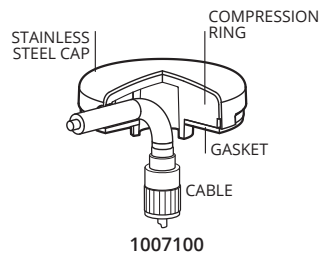

1007100

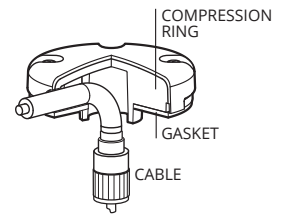

1007

- Simple one-piece design for easy side-entry installations
- Low profile, contoured edge reduces the risk of tangling lines
- 1007100 includes a 316 stainless steel dress cap which conceals mounting hardware and matches other deck hardware
- Stainless steel fasteners included

Ring Material	UV-Stabilized Thermoplastic
Seal Material	UV-Stabilized Buna-N Rubber

Part #	Max. Connector Diameter in (mm)	Max. Cable Diameter in (mm)	Stainless Steel Cap	Mounting Holes Accept
1007	1.00 (25.40)	0.28 (7.112)	--	#8 x 7/8" screws
1007100	1.00 (25.40)	0.28 (7.112)	Yes	#8 x 7/8" screws

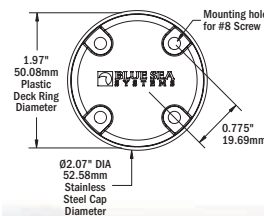

# POWER DISTRIBUTION

**Circuit Breaker Switch  
Water-Resistant**



113

Designed for exposed mounting applications.

**Contura Switch  
Water-Resistant**



114

Complements existing controls commonly used on many boats.

**WeatherDeck®  
Waterproof**



115

Designed for open-cockpit and flybridge applications.

**360 Panel System**



116

Designed with an open frame to mount a broad selection of modules allowing multiple functions to be combined in a single panel.

**Traditional Metal**



117

Suited for use as drop-in replacements or extensions to existing panels.





# POWER DISTRIBUTION

## DC and AC Circuit Breaker



118

Designed to distribute current from a high amperage input into lower amperage circuits.

## AC RCBO Circuit Breaker



126

Reduces the risk of fire and shock hazards caused by defects in boat appliances and circuit wiring.

## AC Source Selection



127

Select between multiple AC sources to supply power to the AC Branch distribution system.

## AC/DC Combination



130

Combines switching, circuit protection, source selection and monitoring into a single panel.

## Custom 360



132

Design and order custom panels online.



**The power distribution panel is the heart of an electrical system.**

Blue Sea Systems manufactures panels suited for all size and distribution requirements of a vessel or vehicle.

## Waterproof & Water-Resistant Panels

Integrated overcurrent protection and switching built to withstand harsh environments for every application

### Water-Resistant Circuit Breaker Switch Panels

Designed for Wet Environments - IP45/IP66 (See inside back cover)

Water-Resistant Circuit Breaker Switch Panels utilize 15A illuminated circuit breakers that provide on indication and switching in one. Integrated switch boot and panel gasket provide IP45/IP66 water resistance for wet environments. Available in gray and camo pattern.



### Contura Switch Water-Resistant Panels

Contemporary Design For Wet Environments - IP66 (See inside back cover)

Using industry standard Contura switches, the Blue Sea Systems Contura Switch Water Resistant Panels are designed to perform above deck, as well as complement any interior. Fuse models are available in a classic gray finish, and circuit breaker models are available in white or black.



### WeatherDeck® Waterproof Panels

Designed For Extreme Environments - IP67 (See inside back cover)

The WeatherDeck Panels are Blue Sea Systems most waterproof panels and their contemporary appearance adds style to any boat. Available in switch only, fuse, and circuit breaker models, the WeatherDeck Panels can be mounted in four orientations for maximum versatility.





## Water-Resistant Circuit Breaker Switch Panels

Designed for exposed mounting applications

- Illuminated 15A circuit breakers provide switching, ON indication and overcurrent protection (7069)
- Industry-standard sizes and mounting allow these panels to be easily retrofitted in an existing application
- Polycarbonate/ABS panel surface is UV-stabilized, flame retardant, and will not corrode
- Silicon breaker boots (4134) and gasket protects against water ingress
- Low profile makes it easy to install in tight spaces
- Fast-on circuit breaker connectors make it quick to wire
- Two-wire connection for powering all panels is simple and requires #10 ring terminals. Terminals screw to bus bars for secure connections
- 4321 & 4324 include a 12/24V, 2.1A DC Dual USB Charger and 12V Socket (p. 24, 25)
- Set of 15 square format circuit labels are included, and are easy to replace. Additional standard or custom labels are available through Blue Sea Systems

Nominal Voltage	12V DC
Amperage Max. Operating	45A
Terminal Type	1/4" Male quick connect
Hardware	Stainless Steel #6 x 5/8" mounting screws
Ring Terminal Size	M5 (#10)
Regulatory	Panel front is IP45 (4321 & 4324 only) or IP66 when mounted with gasket in place - protected against water jets or powerful water jets (see inside back cover)

Part #	Description	Color	Width in (mm)	Height in (mm)	Depth in (mm)	Width Mounting Centers in (mm)	Height Mounting Centers in (mm)
4320	4 positions	Gray	4.625 (117.47)	5.0 (127)	1.75 (44.45)	4.125 (104.77)	4.437 (112.69)
4321	4 pos. + 12V Socket & Dual USB Charger	Gray	4.625 (117.47)	6.625 (168.27)	1.75 (44.45)	4.125 (104.77)	6.125 (155.57)
4322	6 positions	Gray	4.625 (117.47)	6.625 (168.27)	1.75 (44.45)	4.125 (104.77)	6.125 (155.57)
4323	4 positions	Camo	4.625 (117.47)	5.0 (127)	1.75 (44.45)	4.125 (104.77)	4.437 (112.69)
4324	4 pos. + 12V Socket & Dual USB Charger	Camo	4.625 (117.47)	6.625 (168.27)	1.75 (44.45)	4.125 (104.77)	6.125 (155.57)
4325	6 positions	Camo	4.625 (117.47)	6.625 (168.27)	1.75 (44.45)	4.125 (104.77)	6.125 (155.57)



4320 Gray



4323 Camo



4321 Gray



4324 Camo



4322 Gray



4325 Camo

## Contura Switch Water-Resistant Bilge Panels

Consolidated control and circuit protection for up to four bilge pumps

- Designed for 12V or 24V DC systems
- Watertight mounting gasket
- Pre-wired for easy installation
- ON indicating LEDs embedded in all switches
- (ON)-OFF-ON Contura Switches and 15A AGC Fuses

NOTE: Labels are not backlit

Voltage Max. Operating	24V DC
Amperage Operating Current	18 Milliamps per illuminated LED
Switch Rating	20A @ 12V DC, 15A @ 24V DC
Circuit Breaker Rating	15A
Fuse Holder Rating	20A Max. (15A fuses included)
Panel Cumulative Rating	45A
Regulatory	Panel front is IP66 when mounted with gasket in place - protected against powerful water jets (see inside back cover)

Part #	Color	Contura Switches	AGC®/MDL® Fuse Holders	Width in (mm)	Height in (mm)	Depth in (mm)
8263	Gray	1	1	2.25 (57.15)	3.75 (95.25)	3.00 (76.20)
8664	Gray	2	2	3.34 (84.84)	3.75 (95.25)	3.00 (76.20)
8665	Gray	3	3	5.25 (133.35)	3.75 (95.25)	3.00 (76.20)
8666	Gray	4	4	5.25 (133.35)	3.75 (95.25)	3.00 (76.20)



8263



8664



8665



8666



## Contura Switch Water-Resistant Panels

Designed for open-cockpit and flybridge applications using switches to complement existing controls commonly used

- Designed for 12V or 24V DC systems
- Watertight mounting gasket
- ON indicating LEDs embedded in all switches
- Includes Small Format Label Set 8217 (Gray) or 8214 (Black) \* (p. 154)
- 8121, 8421 & 8521 include a 12/24V DC 4.8A USB Charger (p. 24)

NOTE: Labels are not backlit

Voltage Max. Operating	24V DC
Amperage Operating Current	18 Milliamps per illuminated LED
Switch Rating	20A @ 12V DC, 15A @ 24V DC
Circuit Breaker Rating	15A
Fuse Holder Rating	20A Max. (15A fuses included)
Panel Cumulative Rating	45A (all except 8 position panels) 90A (8 position panels)
Regulatory	CE marked, Panel front is IP66 when mounted with gasket in place - protected against powerful water jets (see inside back cover) CIRCUIT BREAKER MODELS ONLY—Meet UL 1500 and ISO 8846 external ignition protection requirements

**IGNITION PROTECTED**



8374



8372



8371



8521



8373



8271



8272



8274



8421



8273



8261



8121



8053

Part #	Color	4.8A Dual USB Charger	Push Button Circuit Breakers	AGC®/MDL® Fuse Holders	Width in (mm)	Height in (mm)	Depth in (mm)
8274	White	--	3	--	4.50 (114.30)	3.75 (95.25)	3.25 (82.55)
8272	White	--	4	--	5.25 (133.35)	4.25 (107.95)	3.25 (82.55)
8273	White	--	6	--	4.50 (114.30)	7.50 (190.50)	3.25 (82.55)
8271	White	--	8	--	9.37 (238.00)	4.25 (107.95)	3.25 (82.55)
8421	White	1	5	--	4.50 (114.30)	7.50 (190.50)	3.25 (82.55)
8374	Black	--	3	--	4.50 (114.30)	3.75 (95.25)	3.25 (82.55)
8372	Black	--	4	--	5.25 (133.35)	4.25 (107.95)	3.25 (82.55)
8373	Black	--	6	--	4.50 (114.30)	7.50 (190.50)	3.25 (82.55)
8371	Black	--	8	--	9.37 (238.00)	4.25 (107.95)	3.25 (82.55)
8521	Black	1	5	--	4.50 (114.30)	7.50 (190.50)	3.25 (82.55)
8054*	Gray	--	--	3	5.25 (133.35)	3.75 (95.25)	3.00 (76.20)
8262	Gray	--	--	4	5.25 (133.35)	3.75 (95.25)	3.00 (76.20)
8053*	Gray	--	--	6	5.25 (133.35)	7.50 (190.50)	3.00 (76.20)
8261	Gray	--	--	8	9.37 (238.00)	3.75 (95.25)	3.00 (76.20)
8121*	Gray	1	--	5	5.25 (133.35)	7.50 (190.50)	3.00 (76.20)



8054



8262

\* 8054, 8053 and 8121 include Large Format Label Set 8030 (p. 154)

# WeatherDeck® Waterproof Panels

Designed for open-cockpit and flybridge applications

- **Fuse Model:** Bicolored LEDs illuminate circuit labels to quickly identify OFF (Red), ON (Green), or Blown (No color) circuits
- **Circuit Breaker Model:** Green LEDs illuminate circuit labels
- **Fuse and Circuit Breaker Models:**
  - Backlighting is compatible with DeckHand Dimmers (p. 27)
  - Independent label backlighting allows switching and dimming
- **Switch Only Model:** No circuit protection or illuminated circuit labels
- Integrated switch guards reduce the risk of accidental switching
- Panels can be mounted in four different orientations
- Panel front rated IP67 when properly mounted with watertight mounting gasket
- UV stabilized weather-resistant faceplate snaps on and off providing access to components and concealing mounting screws
- Square Format Label Set 4215 included (p. 154)

Circuit Breaker Panel	
Voltage Max. Operating	24V DC
Amperage Max. Operating	15A @ 12V DC (per circuit) 9A @ 24V DC (per circuit)
Amperage Operating Current (backlight)	10mA/Illuminated Circuit
Panel Cumulative Rating	45A
Switch Rating	15A Max.
Backlighting Voltage	12V or 24V DC
Backlighting Amperage Draw	10mA/Illuminated Circuit
Circuit Breaker Rating	15A
Regulatory	IP67 - protected against immersion up to 1 meter for 30 minutes (see inside back cover)
Fuse Panel	
Voltage Max. Operating	12V DC
Amperage Max. Operating	15A @ 12V DC (per circuit)
Amperage Operating Current (backlight)	10mA/Illuminated Circuit
Panel Cumulative Rating	2 Position: 30A 4 Position: 60A 6 Position: 90A 8 Position: 100A
Switch Rating	15A Max.
Backlighting Voltage	12V DC Nominal
Fuses Available	1-30A
Regulatory	IP67 - protected against immersion up to 1 meter for 30 minutes (see inside back cover)
Switch Only Panel	
Voltage Max. Operating	24V DC
Amperage Max. Operating	15A @ 12V DC (per circuit)
Switch Rating	15A Max.
Regulatory	IP67 - protected against immersion up to 1 meter for 30 minutes (see inside back cover)



4374 CLB Circuit breakers



4302 ATO/ATC Fuses  
4303 Switch only



4376 CLB Circuit breakers



4304 ATO/ATC Fuses  
4305 Switch only



4378 CLB Circuit breakers



4306 ATO/ATC Fuses  
4307 Switch only



4308 ATO/ATC Fuses  
4309 Switch only

Part #	Pos.	Circuit Breakers	Fuses	Label Backlight	Volts	Width in (mm)	Height in (mm)	Depth in (mm)	Width Mounting Centers in (mm)	Height Mounting Centers in (mm)
4374	4	Yes	---	Yes	12/24V	4.25 (107.95)	4.30 (109.22)	3.50 (88.90)	3.69 (93.73)	3.74 (95.00)
4376	6	Yes	---	Yes	12/24V	4.25 (107.95)	6.00 (152.40)	3.50 (88.90)	3.69 (93.73)	5.44 (138.18)
4378	8	Yes	---	Yes	12/24V	4.25 (107.95)	7.70 (195.58)	3.50 (88.90)	3.69 (93.73)	7.14 (181.36)
4302	2	---	Yes	Yes	12V	3.88 (98.55)	2.60 (66.04)	2.50 (63.50)	3.31 (84.07)	2.04 (51.82)
4304	4	---	Yes	Yes	12V	3.88 (98.55)	4.30 (109.22)	2.50 (63.50)	3.31 (84.07)	3.74 (95.00)
4306	6	---	Yes	Yes	12V	3.88 (98.55)	6.00 (152.40)	2.50 (63.50)	3.31 (84.07)	5.44 (138.18)
4308	8	---	Yes	Yes	12V	3.88 (98.55)	7.70 (195.58)	2.50 (63.50)	3.31 (84.07)	7.14 (181.36)
4303	2	---	---	---	12/24V	3.88 (98.55)	2.60 (66.04)	2.50 (63.50)	3.31 (84.07)	2.04 (51.82)
4305	4	---	---	---	12/24V	3.88 (98.55)	4.30 (109.22)	2.50 (63.50)	3.31 (84.07)	3.74 (95.00)
4307	6	---	---	---	12/24V	3.88 (98.55)	6.00 (152.40)	2.50 (63.50)	3.31 (84.07)	5.44 (138.18)
4309	8	---	---	---	12/24V	3.88 (98.55)	7.70 (195.58)	2.50 (63.50)	3.31 (84.07)	7.14 (181.36)



## 360 Panel System

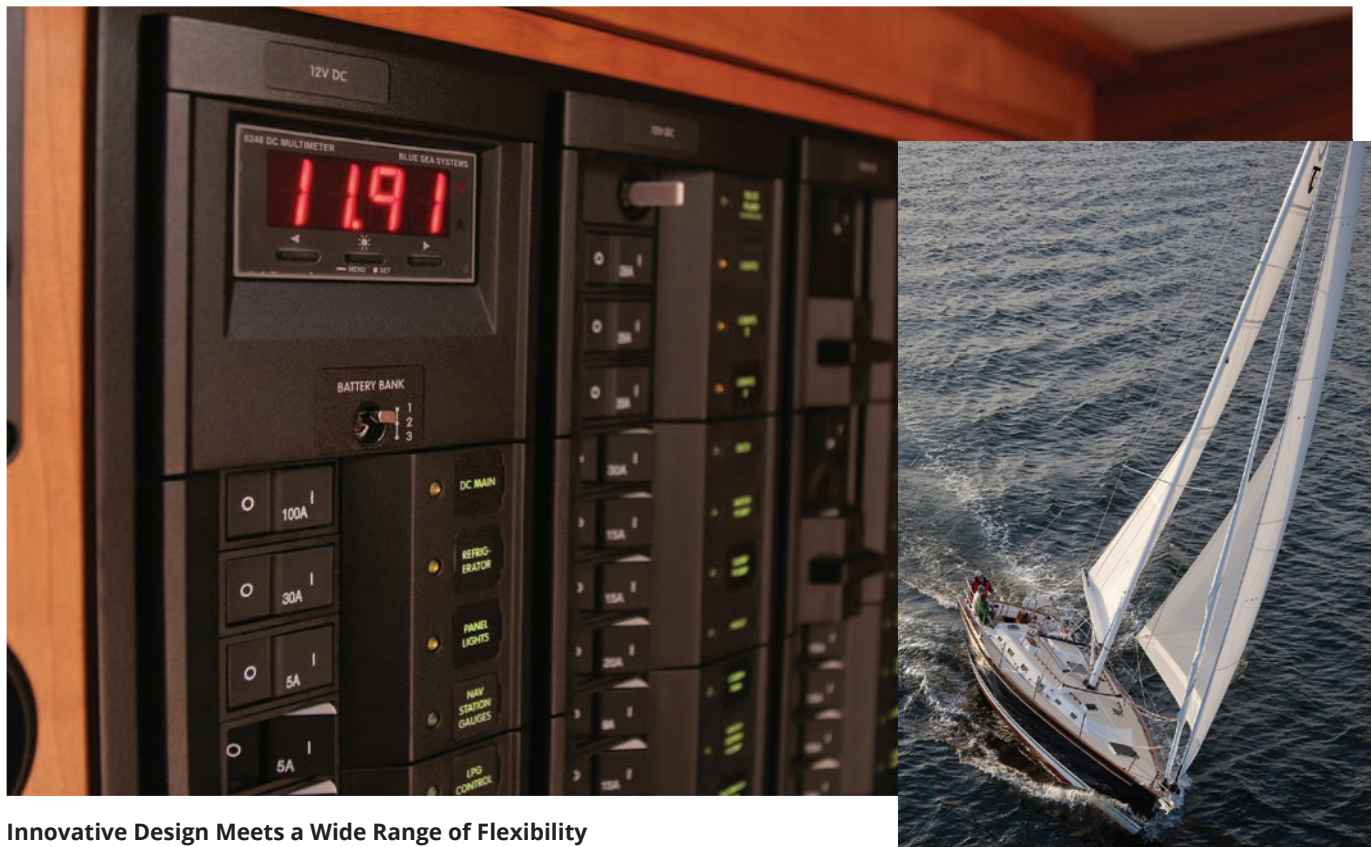

Tartan Yachts uses Blue Sea Systems 360 Panels aboard their boats

### Innovative Design Meets a Wide Range of Flexibility

The 360 Panel System uses an open frame to mount a broad selection of modules allowing multiple functions to be combined in a single panel. This innovative design offers a wide choice of panel features, accommodates future changes, and permits rapid assembly and shipping time. With options ranging from battery management to source selection, the 360 Panel System provides unmatched design flexibility. If you do not find the panel you are looking for in the stock panel offering, please go to page 132 to find out how to create and order a custom panel that will work for your specific application.



Open frame allows future replacement or upgrade of panel modules

### Related Products



Push Button Circuit Breaker Boot page 75



Push Button Reset-Only Circuit Breaker page 75



A-Series Rocker Circuit Breakers page 83



ELCI Main Circuit Breakers page 87



Analog Meters page 140



Digital Meters page 146

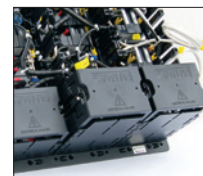

360 Panel Insulating Back Cover page 152



Square Format Labels page 154



# Traditional Metal Panels



Blue Sea Systems' Traditional Metal Panels are a complementary fit on the Blackfin 34 Fisharound

## Styled to Match Existing Panels

The Traditional Metal Panels are suited for use as extensions to existing panels or as full replacements. All panels are pre-wired and include LEDs in all positions. Choose from over 100 stock panels ranging from simple circuit breaker models to complex multi-source AC configurations.

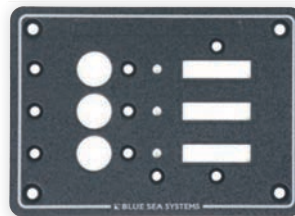

Marine grade aluminum frame securely holds fixed panel components and is chemically treated to resist corrosion (aluminum frame not sold separately)

## Related Products



A-Series Toggle Circuit Breakers page 82



C-Series Toggle Circuit Breaker page 84



ELCI Main Circuit Breakers page 87



Analog Meters page 140



Digital Meters page 146



LED Indicator Lights page 153



Insulating Back Cover page 152



Large Format Labels page 154

## DC Branch Circuit Breaker Panels

Distribute current from a high amperage input into lower amperage circuits

### Features

- ON-indicating LEDs for select models\*
- Backlit label positions for select models\*
- Panels with voltmeters include a toggle switch to monitor voltage on up to three battery banks

### Component References

- A-Series Circuit Breakers (p. 82)
- Push Button Reset-Only Circuit Breakers (p. 75)
- ON-OFF, SPST Rocker Switches (p. 94)
- 360 Panels include 4205 label set (p. 155)
- Traditional Metal Panels include 8030 label set (p. 155)
- DC Digital Multimeter (p. 146)
- DC Analog Meters (p. 140)
- Amber ON-indicating LEDs (p. 153)
- DC M2 Multimeter 1830 (p. 143)
- 4.8A USB Charger & 12V Socket (p. 24, 25)

\* Panels with Push Button Circuit Breakers do not include ON-indicating LEDs or backlit label positions



Part #	8025	1216	1455	1495	1459
Style	Traditional Metal	360 Panel System	360 Panel System	360 Panel System	360 Panel System
Total Positions	3 Positions	4 Positions	4 Positions	4 Positions	4 Positions
Circuit Breakers	3 A-Series, 15A (7210)	4 A-Series, 15A (7403)	4 Push Button, 10A (7054)	4 A-Series, 15A (7403)	4 Push Button, 10A (7054)
Rocker Switches	--	--	4 ON-OFF, SPST (7480)	--	4 ON-OFF, SPST (7480)
Dual USB / Dash Socket	--	--	--	12/24V Dual USB 4.8A (1045) 12V Dash Socket (1011)	--
Nominal Voltage	12/24V DC	12V DC	12V DC	12V DC	12V DC
Maximum Amperage	100A	100A	40A	100A	40A
DC Meter	--	--	--	--	8-16V (8003)
Width x Height in (mm)	5.25 (133.35) x 4.75 (120.65)	4.88 (123.83) x 4.75 (120.65)	4.88 (123.83) x 4.75 (120.65)	4.88(123.83) x 7.75(196.85)	4.88 (123.83) x 7.75 (196.85)
Depth in (mm)	2.50 (63.50)	3.00 (76.20)	3.50 (88.90)	3.50 (88.90)	3.50 (88.90)



Part #	8120	8081	8401	8096	1450
Style	Traditional Metal	Traditional Metal	Traditional Metal	Traditional Metal	360 Panel System
Total Positions	5 Positions	5 Positions	5 Positions	6 Positions	8 Positions
Circuit Breakers	5 A-Series, 15A (7210)	5 A-Series, 15A (7210)	5 A-Series, 15A (7210)	6 A-Series, 15A (7210)	8 Push Button, 15A (7056)
Nominal Voltage	12V DC	12V DC	12/24V DC	12/24V DC	12/24V DC
Maximum Amperage	50A	50A	100A	100A per bus	90A
DC Meter	--	8-16V (8028), 0-50A (8041)	Digital Multimeter (8248)	--	--
Dual USB / Dash Socket	12/24V Dual USB 4.8 (1045) 12V Dash Socket (1011)	--	--	--	--
Width x Height in (mm)	5.25 (133.35) x 7.50 (190.50)	5.25 (133.35) x 7.50 (190.50)	5.25 (133.35) x 7.50 (190.50)	10.50 (266.70) x 3.75 (95.25)	4.88 (123.83) x 4.75 (120.65)
Depth in (mm)	2.50 (63.50)	2.50 (63.50)	4.00 (101.6)	2.50 (63.50)	3.50 (88.90)



Part #	1498	1457	1456	1497
Style	360 Panel System	360 Panel System	360 Panel System	360 Panel System
Total Positions	8 Positions	8 Positions	8 Positions	8 Positions
Circuit Breakers	8 Push Button, 15A (7056)	8 Push Button, 10A (7054)	8 Push Button, 10A (7054)	8 A-Series, 15A (7403)
Rocker Switches	--	8 ON-OFF, SPST (7480)	8 ON-OFF, SPST (7480)	--
Dual USB / Dash Socket	12/24V Dual USB 4.8A (1045) 12V Dash Socket (1011)	--	--	12/24V Dual USB 4.8A (1045) 12V Dash Socket (1011)
Nominal Voltage	12V DC	12V DC	12V DC	12V DC
Maximum Amperage	90A	80A	80A	100A
DC Meter	--	--	--	M2 Multimeter w/SOC (1830)
Width x Height in (mm)	4.88(123.83) x 7.75(196.85)	4.88 (123.83) x 7.75 (196.85)	9.25 (234.95) x 4.75 (120.65)	9.25 (234.95) x 7.75 (196.85)
Depth in (mm)	3.50 (88.90)	3.50 (88.90)	3.50 (88.90)	4.00 (101.60)



Part #	1200	1225	8023	8385	1463
Style	360 Panel System	360 Panel System	Traditional Metal	Traditional Metal	360 Panel System
Total Positions	8 Positions	8 Positions	8 Positions	8 Positions	8 Positions
Circuit Breakers	8 A-Series, 15A (7403)	8 A-Series, 15A (7403)	5 A-Series, 15A (7210)	6 A-Series, 15A (7210)	8 Push Button, 10A (7054)
Rocker Switches	--	--	--	--	8 ON-OFF, SPST (7480)
Nominal Voltage	12V DC	12V DC	12/24V DC	12/24V DC	12V DC
Maximum Amperage	100A	100A per bus	100A	100A per bus	80A
Meter (PN)	--	--	--	--	8-16V (8003)
Width x Height in (mm)	4.88 (123.83) x 7.75 (196.85)	9.25 (234.95) x 4.75 (120.65)	5.25 (133.35) x 7.50 (190.50)	10.50 (266.70) x 4.50 (114.30)	4.88 (123.83) x 10.75 (273.05)
Depth in (mm)	3.00 (76.20)	3.00 (76.20)	2.50 (63.50)	2.50 (63.50)	3.50 (88.90)



Part #	1227	8082	8402	1461	1464
Style	360 Panel System	Traditional Metal	Traditional Metal	360 Panel System	360 Panel System
Total Positions	8 Positions	10 Positions	10 Positions	12 Positions	12 Positions
Circuit Breakers	8 A-Series, 15A (7403)	7 A-Series, 15A (7210)	7 A-Series, 15A (7210)	12 Push Button, 10A (7054)	12 Push Button, 10A (7054)
Rocker Switches	--	--	--	12 ON-OFF, SPST (7480)	12 ON-OFF, SPST (7480)
Nominal Voltage	12V DC	12V DC	12/24V DC	12V DC	12V DC
Maximum Amperage	100A	50A	100A	120A	120A
Meter	Digital Multimeter (8248)	8-16V (8028) / 0-50A (8041)	Digital Multimeter (8248)	--	8-16V (8003)
Width X Height in (mm)	4.88 (123.83) x 10.75 (273.05)	5.25 (133.35) x 11.25 (285.75)	5.25 (133.35) x 11.25 (285.75)	4.88 (123.83) x 10.75 (273.05)	9.25 (234.95) x 7.75 (196.85)
Depth in (mm)	3.00 (76.20)	2.50 (63.50)	4.00 (101.6)	3.50 (88.90)	3.50 (88.90)



Part #	1223	1217	1496	8375
Style	360 Panel System	360 Panel System	360 Panel System	Traditional Metal
Total Positions	12 Positions	12 Positions	12 Positions	12 Positions
Circuit Breakers	12 A-Series, 15A (7403)	12 A-Series, 15A (7403)	12 A-Series, 15A (7403)	10 A-Series, 15A (7210)
Nominal Voltage	12V DC	12V DC	12/24V DC	12/24V DC
Maximum Amperage	100A	100A per bus	100A	100A per bus
DC Meter	--	Digital Multimeter (8248)	M2 Multimeter w/SOC (1830)	--
Width x Height in (mm)	4.88 (123.83) x 10.75 (273.05)	9.25 (234.95) x 7.75 (196.85)	9.25 (234.95) x 7.75 (196.85)	14.75 (374.65) x 4.50 (114.30)
Depth in (mm)	3.00 (76.20)	4.00 (101.60)	4.00 (101.60)	2.50 (63.50)

\* Panels with Push Button Circuit Breakers do not include ON-indicating LEDs or backlit label positions



## DC Branch Circuit Breaker Panels (continued)



Part #	8376	8068	8403
Style	Traditional Metal	Traditional Metal	Traditional Metal
Total Positions	13 Positions	13 Positions	13 Positions
Circuit Breakers	10 A-Series, 15A (7210)	10 A-Series, 15A (7210)	10 A-Series, 15A (7210)
Nominal Voltage	12/24V DC	12V DC	12/24V DC
Maximum Amperage	100A	50A	100A per bus
DC Meter	--	8-16V (8028) , 0-50A (8041)	Digital Multimeter (8248)
Width x Height in (mm)	5.25 (133.35) x 11.25 (285.75)	10.50 (266.70) x 7.50 (190.50)	10.50 (266.70) x 7.50 (190.50)
Depth in (mm)	2.50 (63.50)	3.00 (76.20)	4.00 (101.6)



Part #	1222	8377	1201
Style	360 Panel System	Traditional Metal	360 Panel System
Total Positions	16 Positions	16 Positions	16 Positions
Circuit Breakers	16 A-Series, 15A (7403)	10 A-Series, 15A (7210)	16 A-Series, 15A (7403)
Nominal Voltage	12V DC	12/24V DC	12V DC
Maximum Amperage	100A per bus	100A per bus	50A
DC Meter	--	--	8-16V (8003) / 0-50A (8022)
Width in (mm)	9.25 (234.95)	10.50 (266.70)	13.63 (346.08)
Height in (mm)	7.75 (196.85)	7.50 (190.50)	7.75 (196.85)
Depth in (mm)	3.00 (76.20)	2.50 (63.50)	3.00 (76.20)



Part #	8378	1221	8379
Style	Traditional Metal	360 Panel System	Traditional Metal
Total Positions	18 Positions	Main + 19 Positions	Main + 20 Positions
Circuit Breakers	15 A-Series, 15A (7210)	1 C-Series, 100A (7549) , 19 A-Series, 15A (7403)	1 C-Series, 100A (7250I) , 14 A-Series, 15A (7210)
Nominal Voltage	12V DC	12V DC	12/24V DC
Maximum Amperage	100A	100A	100A
DC Meter	8-16V (8003) / 0-100A (8017)	Digital Multimeter (8248)	Digital Multimeter (8248)
Width in (mm)	14.75 (374.65)	13.63 (346.08)	14.75 (374.65)
Height in (mm)	7.50 (190.50)	7.75 (196.85)	7.50 (190.50)
Depth in (mm)	2.50 (63.50)	4.00 (101.60)	4.00 (101.6)



8380



8264

Part #	8380	8264
Style	Traditional Metal	Traditional Metal
Total Positions	Main + 22 Positions	24 Positions
Circuit Breakers	1 C-Series, 100A (7250I) , 16 A-Series, 15A (7210)	15 A-Series, 15A (7210)
Nominal Voltage	12V DC	12/24V DC
Maximum Amperage	100A	100A per bus
DC Meter	8-16V (8028) / 0-100A Micro	---
Width in (mm)	10.50 (266.70)	14.75 (374.65)
Height in (mm)	11.25 (285.75)	7.50 (190.50)
Depth in (mm)	3.00 (76.20)	2.50 (63.50)



8381



8382

Part #	8381	8382
Style	Traditional Metal	Traditional Metal
Total Positions	Main + 32 Positions	Main + 35 Positions
Circuit Breakers	1 C-Series, 100A (7250I) , 23 A-Series, 15A (7210)	1 C-Series, 100A (7250I) , 26 A-Series, 15A (7210)
Nominal Voltage	12V DC	12/24V DC
Maximum Amperage	100A	100A
DC Meter	8-16V (8003) / 0-100A (8017)	Digital Multimeter (8248)
Width in (mm)	14.75 (374.65)	14.75 (374.65)
Height in (mm)	11.25 (285.75)	11.25 (285.75)
Depth in (mm)	3.00 (76.20)	4.00 (101.6)



## AC Main Circuit Breaker Panels

Provides a path for delivering power from the AC source to the AC branch distribution system

### Features

- Red reverse polarity indication LED
- Green ON indicating LEDs
- Backlit label positions

### Component References

- A-Series Circuit Breakers (p. 82)
- AC Analog Meters (p. 141)
- AC Digital Multimeter (p. 147)
- Red reverse polarity indication LED (p. 153)
- Green ON indicating LEDs (p. 153)
- Traditional Metal Panels include 8031 label set (p. 154)
- 360 Panels include 4206 label set (p. 155)
- Source selection label set included with panels 8077, 8177, 8079, and 8179 (p. 155)
- M2 AC Multimeter (p. 142)

See page 88 for a discussion of ABYC ELCI recommendations for AC Main circuit protection.



Part #	8077 / 8177*		8079 / 8179*		8029 / 8129*		1214 / 1215*	
Style	Traditional Metal		Traditional Metal		Traditional Metal		360 Panel System	
Total Positions	Main Only		Main Only		Main + 1 position		Main + 2 positions	
A-Series Circuit Breakers	Main, 30A (7238)	Main, 16A (7294)	Main, 50A (7242)	Main, 32A (7295)	Main, 30A (7238)	Main, 16A (7294)	Main, 30A (7414) 2 Branch, 15A (7403)	Main, 16A (7412) 2 Branch, 8A (7401)
Nominal Voltage	120V AC	230V AC	120V AC	230V AC	120V AC	230V AC	120V AC	230V AC
Actuator Style	White Toggle		White Toggle		White Toggle		Flat Rocker	
Insulating Back Cover	---		---		4026 sold separately (p. 152)		1331 sold separately (p. 152)	
Width x Height in (mm)	2.63 (66.80) x 3.75 (95.25)		2.63 (66.80) x 3.75 (95.25)		5.25 (133.35) x 3.75 (95.25)		4.88 (123.83) x 4.75 (120.65)	
Depth in (mm)	2.50 (63.50)		2.50 (63.50)		2.50 (63.50)		3.00 (76.20)	



Part #	1206 / 1207*		8043 / 8143*		8409 / 8509*		8405 / 8505*	
Style	360 Panel System		Traditional Metal		Traditional Metal		Traditional Metal	
Total Positions	Main + 2 positions		Main + 3 positions		Main + 3 positions		Main + 3 positions	
A-Series Circuit Breakers	Main, 30A (7414) 2 Branch, 15A (7403)	Main, 16A (7412) 2 Branch, 8A (7401)	Main, 30A (7238) 3 Branch, 15A (7210)	Main, 16A (7294) 3 Branch, 8A (7299)	Main, 30A (7238) 3 Branch, 15A (7210)	Main, 16A (7294) 3 Branch, 8A (7299)	Main, 30A (7238) 3 Branch, 15A (7210)	Main, 16A (7294) 3 Branch, 8A (7299)
Nominal Voltage	120V AC	230V AC	120V AC	230V AC	120V AC	230V AC	120V AC	230V AC
Actuator Style	Flat Rocker		White Toggle		White Toggle		White Toggle	
AC Meter	0-150V (9353)	0-250V (8245)	0-150V (9353)	0-250V (8245)	0-150V (8244) 0-50A (8246)	0-250V (8245) 0-50A (8246)	Digital Multimeter (8247)	
Insulating Back Cover	2 x 1331 sold separately (p. 152)		4027 sold separately (p. 152)		4027 sold separately (p. 152)		4027 sold separately (p. 152)	
Width x Height in (mm)	4.88 (123.83) x 7.75 (196.85)		5.25 (133.35) x 7.50 (190.50)		5.25 (133.35) x 7.50 (190.50)		5.25 (133.35) x 7.50 (190.50)	
Depth in (mm)	3.00 (76.20)		2.50 (63.50)		3.00 (76.20)		4.00 (101.60)	



Part #	8099 / 8199*		8027 / 8127*		8412 / 8512*		1230 / 1233*	
Style	Traditional Metal		Traditional Metal		Traditional Metal		360 Panel System	
Total Positions	Main + 4 positions		Main + 6 positions		Main + 6 positions		Main + 6 positions	
A-Series Circuit Breakers	Main, 30A (7238) 4 Branch, 15A (7210)	Main, 16A (7294) 4 Branch, 8A (7299)	Main, 30A (7238) 3 Branch, 15A (7210)	Main, 16A (7294) 3 Branch, 8A (7299)	Main, 30A (7238) 4 Branch, 15A (7210)	Main, 16A (7294) 4 Branch, 8A (7299)	Main, 30A (7414) 6 Branch, 15A (7403)	Main, 16A (7412) 6 Branch, 8A (7401)
Nominal Voltage	120V AC	230V AC	120V AC	230V AC	120V AC	230V AC	120V AC	230V AC
Actuator Style	White Toggle		White Toggle		White Toggle		Flat Rocker	
Insulating Back Cover	---		4027 sold separately (p. 152)		---		2 x 1331 sold separately (p. 152)	
Width x Height in (mm)	10.50 (266.70) x 3.75 (95.25)		5.25 (133.35) x 7.50 (190.50)		10.50 (266.70) x 4.50 (114.30)		9.25 (234.95) x 4.75 (120.65)	
Depth in (mm)	2.50 (63.50)		2.50 (63.50)		2.50 (63.50)		3.00 (76.20)	

\*230 Volt (typical of Europe)





Part #	1202 / 1203*		1505	8074 / 8174*		8488 / 8588*	
Style	360 Panel System		360 Panel System	Traditional Metal		Traditional Metal	
Total Positions	Main + 6 positions		Main + 6 positions	Main + 8 positions		Main + 8 positions	
A-Series Circuit Breakers	Main, 30A (7414) 6 Branch, 15A (7403)	Main, 16A (7412) 6 Branch, 8A (7401)	Main, 30A (7414) 6 Branch, 15A (7403)	Main, 30A (7238) 5 Branch, 15A (7210)	Main, 16A (7294) 5 Branch, 8A (7299)	Main, 30A (7238) 5 Branch, 15A (7210)	Main, 16A (7294) 5 Branch, 8A (7299)
Nominal Voltage	120V AC	230V AC	120V AC	120V AC	230V AC	120V AC	230V AC
Actuator Style	Flat Rocker		Flat Rocker	White Toggle		White Toggle	
AC Meter	---		M2 AC Multimeter (1838)	0-150V (8244) 0-50A (8246)	0-250V (8245) 0-50A (8246)	0-150V (9353)	0-250V (9354)
Insulating Back Cover	2 x 1331 sold separately (p. 152)		---	---		---	
Width x Height in (mm)	4.88 (123.83) x 7.75 (196.85)		4.88 (123.82) x 10.75 (273.05)	5.25 (133.35) x 11.25 (285.75)		5.25 (133.35) x 11.25 (285.75)	
Depth in (mm)	3.00 (76.20)		4.00 (101.60)	3.00 (76.20)		2.50 (63.50)	



Part #	8406 / 8506*		8485 / 8585*		8076 / 8176*	
Style	Traditional Metal		Traditional Metal		Traditional Metal	
Total Positions	Main + 8 positions		Main + 11 positions		Main + 11 positions	
A-Series Circuit Breakers	Main, 30A (7238) 5 Branch, 15A (7210)	Main, 16A (7294) 5 Branch, 8A (7299)	Main, 30A (7238) 8 Branch, 15A (7210)	Main, 16A (7294) 8 Branch, 8A (7299)	Main, 30A (7238) 8 Branch, 15A (7210)	Main, 16A (7294) 8 Branch, 8A (7299)
Nominal Voltage	120V AC	230V AC	120V AC	230V AC	120V AC	230V AC
Actuator Style	White Toggle		White Toggle		White Toggle	
AC Meter	Digital Multimeter (8247)		---		0-150V (8244) 0-50A (8246)	0-250V (8245) 0-50A (8246)
Insulating Back Cover	---		---		---	
Width x Height in (mm)	5.25 (133.35) x 11.25 (285.75)		5.25 (133.35) x 11.25 (285.75)		10.50 (266.70) x 7.50 (190.50)	
Depth in (mm)	4.00 (101.60)		2.50 (63.50)		3.00 (76.20)	



Part #	8407 / 8507*		8464 / 8564*		8465 / 8565*	
Style	Traditional Metal		Traditional Metal		Traditional Metal	
Total Positions	Main + 11 positions		Main + 14 positions		Main + 22 positions	
A-Series Circuit Breakers	Main, 30A (7238) 8 Branch, 15A (7210)	Main, 16A (7294) 8 - Branch, 8A (7299)	Main, 30A (7238) 8 Branch, 15A (7210)	Main, 16A (7294) 8 Branch, 8A (7299)	Main, 30A (7238) 13 Branch, 15A (7210)	Main, 16A (7294) 13 Branch, 8A (7299)
Nominal Voltage	120V AC	230V AC	120V AC	230V AC	120V AC	230V AC
Actuator Style	White Toggle		White Toggle		White Toggle	
AC Meter	Digital Multimeter (8247)		---		---	
Width x Height in (mm)	10.50 (266.70) x 7.50 (190.50)		10.50 (266.70) x 7.50 (190.50)		14.75 (374.65) x 7.50 (190.50)	
Depth in (mm)	4.00 (101.60)		2.50 (63.50)		2.50 (63.50)	

\*230 Volt (typical of Europe)

## AC Branch Circuit Breaker Panels

Distributes current from high amperage inputs into lower amperage circuits

### Features

- On indicating LEDs in all circuit positions
- Backlit label positions

### Component References

- A-Series Circuit Breakers (p. 82)
- AC Analog Meters (p. 141)
- 360 Panels include 4206 label set (p. 155)
- Traditional Metal Panels include 8031 label set (p. 154)
- Green ON-indicating LEDs (p. 153)



Part #	8058 / 8158*		1210 / 1211*		8097 / 8197*	
Style	Traditional Metal		360 Panel System		Traditional Metal	
Total Positions	3 Positions		4 Positions		6 Positions	
Circuit Breakers	3 A-Series, 15A (7210)	3 A-Series, 8A (7299)	4 A-Series, 15A (7403)	4 A-Series, 8A (7401)	6 A-Series, 15A (7210)	6 A-Series, 8A (7299)
Nominal Voltage	120V AC	230V AC	120V AC	230V AC	120V AC	230V AC
Maximum Amperage	100A		100A		100A per bus	
Actuator Style	White Toggle		Flat Rocker		White Toggle	
Insulating Back Cover	4026 sold separately (p. 152)		1331 sold separately (152)		--	
Width x Height in (mm)	5.25 (133.35) x 3.75 (95.25)		4.88 (123.83) x 4.75 (120.65)		10.50 (266.70) x 3.75 (95.25)	
Depth in (mm)	2.50 (63.50)		3.00 (76.20)		2.50 (63.50)	



Part #	1228 / 1229*		8059 / 8159*	
Style	360 Panel System		Traditional Metal	
Total Positions	8 Positions		8 Positions	
Circuit Breakers	8 A-Series, 15A (7403)	8 A-Series, 8A (7401)	5 A-Series, 15A (7210)	5 A-Series, 8A (7299)
Nominal Voltage	120V AC	230V AC	120V AC	230V AC
Maximum Amperage	100A		100A	
Actuator Style	Flat Rocker		White Toggle	
Insulating Back Cover	2 x 1331 sold separately (p. 152)		4027 sold separately (p. 152)	
Width x Height in (mm)	4.88 (123.83) x 7.75 (196.85)		5.25 (133.35) x 7.50 (190.50)	
Depth in (mm)	3.00 (76.20)		2.50 (63.50)	



Part #	8411 / 8511*		8478 / 8578*		8480 / 8580*	
Style	Traditional Metal		Traditional Metal		Traditional Metal	
Total Positions	8 Positions		10 Positions		13 Positions	
Circuit Breakers	6 A-Series, 15A (7210)	6 A-Series, 8A (7299)	7 A-Series, 15A (7210)	7 A-Series, 8A (7299)	10 A-Series, 15A (7210)	10 A-Series, 8A (7299)
Nominal Voltage	120V AC	230V AC	120V AC	230V AC	120V AC	230V AC
Maximum Amperage	100A per bus		100A		100A	
Actuator Style	White Toggle		White Toggle		White Toggle	
Meter (PN)	--		0-150V (9353)	0-250V (9354)	--	
Insulating Back Cover	--		--		--	
Width x Height in (mm)	10.50 (266.70) x 4.50 (114.30)		5.25 (133.35) x 11.25 (285.75)		5.25 (133.35) x 11.25 (285.75)	
Depth in (mm)	2.50 (63.50)		2.50 (63.50)		2.50 (63.50)	

\*230 Volt (typical of Europe)



Part #	8479 / 8579*		8461 / 8561*		8265 / 8165*	
Style	Traditional Metal		Traditional Metal		Traditional Metal	
Total Positions	13 Positions		16 Positions		24 Positions	
Circuit Breakers	10 A-Series, 15A (7210)	10 A-Series, 8A (7299)	10 A-Series, 15A (7210)	10 A-Series, 8A (7299)	15 A-Series, 15A (7210)	15 A-Series, 8A (7299)
Nominal Voltage	120V AC	230V AC	120V AC	230V AC	120V AC	230V AC
Maximum Amperage	100A per bus		100A per bus		100A per bus	
AC Meter	0-150V (9353)	0-250V (9354)	--		--	
Actuator Style	White Toggle		White Toggle		White Toggle	
Insulating Back Cover	--		--		--	
Width in (mm)	10.50 (266.70) x 7.50 (190.50)		10.50 (266.70) x 7.50 (190.50)		14.75 (374.64) x 7.50 (190.50)	
Depth in (mm)	2.50 (63.50)		2.50 (63.50)		2.50 (63.50)	

\*230 Volt (typical of Europe)

### AC 120/240 Volt (60Hz) Circuit Breaker Panels

Provides circuit protection for 240V AC systems

- 1168 Provides 1 spare rocker aperture
- C-Series Circuit Breakers (p. 80)



Part #	7372	1168
Style	Traditional Metal	360 Panel System
Total Positions	Main Only	Main + 1 position
Circuit Breaker	C-Series, 1 Main, 50A (7287)	C-Series, 1 Main, 50A (7565)
Poles	3	3
Nominal Voltage	120/240V	120/240V
Maximum Voltage	240V AC	240V AC
Actuator Style	White Toggle	Flat Rocker
Width in (mm)	5.25 (133.35)	4.88 (123.83)
Height in (mm)	3.75 (95.25)	4.75 (120.65)
Depth in (mm)	3.00 (76.20)	3.00 (76.20)





## AC Residual Current Circuit Breaker Panels

Reduces the risk of fire and shock hazards caused by defects in appliances and circuit wiring

### Features

- Provides Main circuit protection with branch circuits

### Component References

- ELCI Main Circuit Breakers (p. 87)
- A-Series Circuit Breakers (p. 82)
- AC Analog Meters (p. 141)
- M2 AC Multimeter (p. 142)

See page 88 for a discussion of ABYC ELCI recommendations for AC Main circuit protection.



Part #	1502	8100	1190	8101
Style	360 Panel System	Traditional Metal	360 Panel System	Traditional Metal
Total Positions	ELCI + 1 Position	ELCI	ELCI + 1 position	ELCI + 5 positions
GFCI/ELCI Circuit Breaker	1 - ELCI Main, 30A (3102)	1 - ELCI Main, 30A (3106)	1 - ELCI Main, 30A (3102)	1 - ELCI Main, 30A (3106)
A-Series Circuit Breaker	---	---	1 - Branch, 15A AC (7403)	2 - Branch, 15A (7210)
Amperage Trip Reference	30A	30A	30A	30A
Leakage Trip Amperage	30mA	30mA	30mA	30mA
Maximum Voltage	120V	120V	120V	120V
Actuator Style	Flat Rocker	White Toggle	Flat Rocker	White Toggle
Insulating Panel Back	1331 sold separately (p. 152)	---	1331 sold separately (p. 152)	---
Width x Height in (mm)	4.88 (123.83) x 4.75 (120.65)	5.25 (133.35) x 3.75 (95.25)	4.88 (123.83) x 4.75 (120.65)	5.25 (133.35) x 7.50 (190.50)
Depth in (mm)	3.99 (101.4)	3.50 (88.90)	3.99 (101.4)	3.50 (88.90)



Part #	8102	1193	1503	1504
Style	Traditional Metal	360 Panel System	360 Panel System	360 Panel System
Total Positions	ELCI + 2 positions	ELCI + 5 positions	ELCI + 5 positions	ELCI + 5 positions
ELCI Circuit Breaker	1 - ELCI Main, 30A AC (3106)	1 - ELCI Main, 30A AC (3102)	1 - ELCI Main, 30A AC (3102)	1 - ELCI Main, 30A AC (3102)
A-Series Circuit Breaker	2 - Branch, 15A AC (7210)	4 - Branch, 15A AC (7403)	5 - Branch, 15A AC (7403)	5 - Branch, 15A AC (7403)
Amperage Trip Reference	30A AC	30A AC	30A AC	30A AC
Leakage Trip Amperage	30mA	30mA	30mA	30mA
Maximum Voltage	120V AC	120V AC	120V AC	120V AC
Actuator Style	White Toggle	Flat Rocker	Flat Rocker	Flat Rocker
Insulating Panel Back	---	2 x 1331 sold separately (p. 152)	2 x 1331 sold separately (p. 152)	2 x 1331 sold separately (p. 152)
AC Meter	0-150V (9353)	---	---	M2 AC Multimeter (1838)
Width x Height in (mm)	5.25 (133.35) x 7.50 (190.50)	9.25 (234.95) x 4.75 (120.65)	4.88(123.83) x 7.75(196.85)	4.88 (123.83) x 10.75 (273.05)
Depth in (mm)	3.50 (88.9)	3.99 (101.4)	3.99 (101.40)	3.99 (101.40)

## AC Source Selection Circuit Breaker Panels

Allows selecting between multiple AC sources to supply power to the AC branch distribution system

### Features

- Lockout slides ensure that no two sources of AC power are connected to the circuit simultaneously
- Backlit label positions

### Component References

- A-Series Circuit Breakers (p. 82)
- AC Analog Meters (p. 141)
- AC Digital Multimeter (p. 147)
- Red reverse polarity indication LED (p. 153)
- Green ON indicating LEDs (p. 153)
- Traditional Metal Panels with branch circuit breakers include 8031 label set (p. 154)
- 360 Panels with branch circuit breakers include 4206 label set (p. 155)
- All panels include a reverse polarity label and a source selection label set (p. 155)



Part #	1208 / 1209*		1231 / 1232*		8032 / 8132*		8061 / 8161*	
Style	360 Panel System		360 Panel System		Traditional Metal		Traditional Metal	
Total Positions	2 Sources		2 Sources		2 Sources		2 Sources	
A-Series Circuit Breakers	2 Main, 30A (7574)	2 Main, 16A (7572)	2 Main, 50A (7577)	2 Main, 32A (7575)	2 Main, 30A (7238)	2 Main, 16A (7294)	2 Main, 50A (7242)	2 Main, 32A (7295)
Nominal Voltage	120V AC	230V AC	120V AC	230V AC	120V AC	230V AC	120V AC	230V AC
Actuator Style	Raised Rocker		Raised Rocker		White Toggle		White Toggle	
Insulating Back Cover	1331 sold separately (p. 152)		1331 sold separately (p. 152)		4026 sold separately (p. 152)		4026 sold separately (p. 152)	
Width x Height in (mm)	4.88 (123.83) x 4.75 (120.65)		4.88 (123.83) x 4.75 (120.65)		5.25 (133.35) x 3.00 (76.20)		5.25 (133.35) x 3.00 (76.20)	
Depth in (mm)	3.00 (76.20)		3.00 (76.20)		3.00 (76.20)		3.00 (76.20)	



Part #	8498 / 8598*		8499 / 8599*		8467 / 8567*	
Style	Traditional Metal		Traditional Metal		Traditional Metal	
Total Positions	3 Sources + Transfer		2 Sources + 4 positions		2 Sources + 4 positions	
A-Series Circuit Breakers	2 Main, 30A (7238) 1 Main, 50A (7242) 1 Transfer, 30A (7238)	2 Main, 16A (7294) 1 Main, 32A (7295) 1 Transfer, 16A (7294)	2 Main, 30A (7238) 2 Branch, 15A (7210)	2 Main, 16A (7294) 2 Branch, 8A (7299)	2 Main, 30A (7238) 2 Branch, 15A (7210)	2 Main, 16A (7294) 2 Branch, 8A (7299)
Nominal Voltage	120V AC	230V AC	120V AC	230V AC	120V AC	230V AC
Actuator Style	White Toggle		White Toggle		White Toggle	
Insulating Back Cover	---		---		4027 sold separately (p. 152)	
Width x Height in (mm)	10.50 (266.70) x 4.50 (114.30)		10.50 (266.70) x 4.50 (114.30)		5.25 (133.35) x 7.50 (190.50)	
Depth in (mm)	3.00 (76.20)		3.00 (76.20)		3.00 (76.20)	



Part #	8489 / 8589*		8462 / 8562*		8466 / 8566*	
Style	Traditional Metal		Traditional Metal		Traditional Metal	
Total Positions	2 Sources + 6 positions		2 Sources + 9 positions		2 Sources + 9 positions	
A-Series Circuit Breakers	2 Main, 30A (7238) 3 Branch, 15A (7210)	2 Main, 16A (7294) 3 Branch, 8A (7299)	2 Main, 30A (7238) 6 Branch, 15A (7210)	2 Main, 16A (7294) 6 Branch, 8A (7299)	2 Main, 30A (7238) 6 Branch, 15A (7210)	2 Main, 16A (7294) 6 Branch, 8A (7299)
Nominal Voltage	120V AC	230V AC	120V AC	230V AC	120V AC	230V AC
Actuator Style	White Toggle		White Toggle		White Toggle	
Meter	0-150V (9353)	0-250V (9354)	0-150V (9353)	0-250V (9354)	---	
Insulating Back Cover	---		---		---	
Width x Height in (mm)	5.25 (133.35) x 11.25 (285.75)		10.50 (266.70) x 7.50 (190.50)		5.25 (133.35) x 11.25 (285.75)	
Depth in (mm)	3.00 (76.20)		3.00 (76.20)		3.00 (76.20)	

\*230 Volt (typical of Europe)

## AC Source Selection Rotary Switch Panels

Provides a solution for managing AC sources when circuit protection is provided elsewhere

- Panels include green ON and red Reverse Polarity indicating LEDs and source selection label set (p. 155)
- 360 Panel System panels include backlit label positions

### 30 Amp 2 Positions + OFF, 2 Pole Rotary Switch

- Switches 2 sources
- Allows connecting one of two different AC sources to one circuit

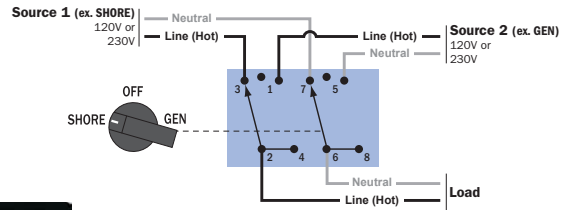

Regulatory  
CE marked  
UL listed



Part #	9009	1481	1484*	8367	8359*
Style	Rotary Switch	360 Panel System	360 Panel System	Traditional Metal	Traditional Metal
Max. Operating V AC	600V AC	120V AC	230V AC	120V AC	230V AC
Wire Size Range	14-10 AWG	14-10 AWG	14-10 AWG	14-10 AWG	14-10 AWG
Insulating Panel Back	--	1331 sold separately (p. 152)	1331 sold separately (p. 152)	4026 sold separately (p. 152)	4026 sold separately (p. 152)
Width x Height in (mm)	1.89 (48.00) x 1.89 (48.00)	4.88 (123.83) x 4.75 (120.65)	4.88 (123.83) x 4.75 (120.65)	5.25 (133.35) x 3.75 (95.25)	5.25 (133.35) x 3.75 (95.25)
Depth in (mm)	1.91 (48.51)	1.91 (48.51)	1.91 (48.51)	1.91 (48.51)	1.91 (48.51)

### 65 Amp 2 Positions + OFF, 2 Pole Rotary Switch

- Switches 2 sources
- Allows connecting one of two different AC sources to one circuit

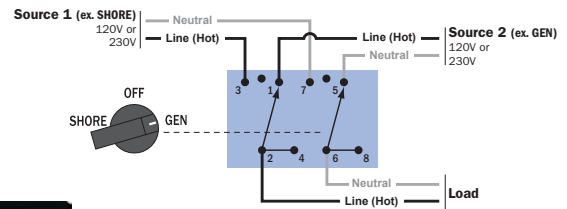

Regulatory  
CE marked  
UL listed



Part #	9011	1483	1486*	8365	8357*
Style	Rotary Switch	360 Panel System	360 Panel System	Traditional Metal	Traditional Metal
Max. Operating V AC	600V AC	120V AC	230V AC	120V AC	230V AC
Wire Size Range	12-6 AWG	12-6 AWG	12-6 AWG	12-6 AWG	12-6 AWG
Insulating Panel Back	--	1331 sold separately (p. 152)	1331 sold separately (p. 152)	4026 sold separately (p. 152)	4026 sold separately (p. 152)
Width x Height in (mm)	2.52 (64.00) x 2.52 (64.00)	4.88 (123.83) x 4.75 (120.65)	4.88 (123.83) x 4.75 (120.65)	5.25 (133.35) x 3.75 (95.25)	5.25 (133.35) x 3.75 (95.25)
Depth in (mm)	2.41 (61.21)	2.41 (61.21)	2.41 (61.21)	2.41 (61.21)	2.41 (61.21)

### 30 Amp 3 Positions + OFF, 2 Pole Rotary Switch

- Switches 3 sources
- Allows connecting one of three different AC sources to one circuit

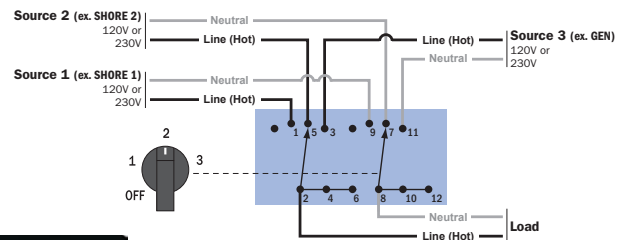

Regulatory  
CE marked  
UL listed



Part #	9010	1482	1485*	8366	8358*
Style	Rotary Switch	360 Panel System	360 Panel System	Traditional Metal	Traditional Metal
Max. Operating V AC	600V AC	120V AC	230V AC	120V AC	230V AC
Wire Size Range	14-10 AWG	14-10 AWG	14-10 AWG	14-10 AWG	14-10 AWG
Insulating Panel Back	--	1331 sold separately (p. 152)	1331 sold separately (p. 152)	4026 sold separately (p. 152)	4026 sold separately (p. 152)
Width x Height in (mm)	1.89 (48.00) x 1.89 (48.00)	4.88 (123.83) x 4.75 (120.65)	4.88 (123.83) x 4.75 (120.65)	5.25 (133.35) x 3.75 (95.25)	5.25 (133.35) x 3.75 (95.25)
Depth in (mm)	2.41 (61.21)	2.41 (61.21)	2.41 (61.21)	2.41 (61.21)	2.41 (61.21)

\*230 Volt (typical of Europe)



### 65 Amp 2 Positions + OFF, 3 Pole Rotary Switch

- Allows connecting one of two different AC sources to one circuit
- Switches 2-120/240V AC sources
- Switches both lines (hots) and neutral

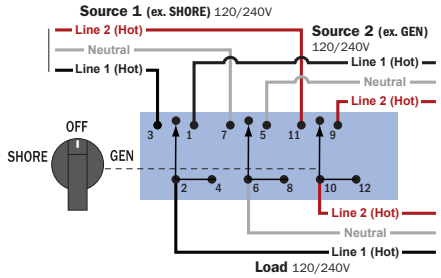

Regulatory  
CE marked  
UL listed



Part #	9019	1487	8363
Style	Rotary Switch	360 Panel System	Traditional Metal
Max. Operating V AC	600V AC	240V AC	240V AC
Wire Size Range	12-6 AWG	12-6 AWG	12-6 AWG
Insulating Panel Back	---	---	---
Width x Height in (mm)	2.52 (64.00) x 2.52 (64.00)	4.88 (123.83) x 4.75 (120.65)	5.25 (133.35) x 3.75 (95.25)
Depth in (mm)	3.65 (92.71)	3.65 (92.71)	3.65 (92.71)

### 30 Amp 2 Positions + OFF, 4 Pole Rotary Switch

- Switches between 2-120V AC shore power sources and 1-120/240 Volt AC source to 2-120 Volt AC load groups
- Switches both lines (hots) and neutral

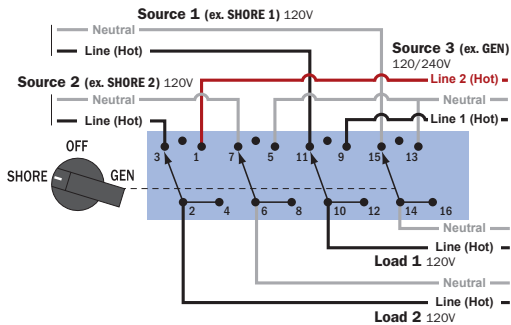

Regulatory  
CE marked  
UL listed



Part #	6337	1489	8386
Style	Rotary Switch	360 Panel System	Traditional Metal
Max. Operating V AC	600V AC	240V AC	240V AC
Wire Size Range	14-10 AWG	14-10 AWG	14-10 AWG
Insulating Panel Back	---	1331 sold separately (p. 152)	-
Width x Height in (mm)	1.89 (48.00) x 1.89 (48.00)	4.88 (123.83) x 4.75 (120.65)	5.25 (133.35) x 3.75 (95.25)
Depth in (mm)	2.98 (75.69)	2.98 (75.69)	2.98 (75.69)

### 65 Amp 2 Positions + OFF, 4 Pole Rotary Switch

- Switches between 2-120V AC shore power sources and 1-120/240 Volt AC source to 2-120 Volt AC load groups
- Switches both lines (hots) and neutral

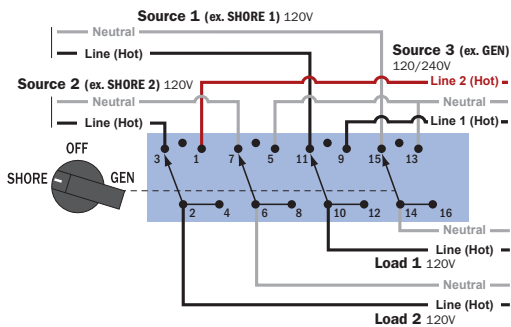

Regulatory  
CE marked  
UL listed



Part #	9093	1480	8369
Style	Rotary Switch	360 Panel System	Traditional Metal
Max. Operating V AC	600V AC	240V AC	240V AC
Wire Size Range	12-6 AWG	12-6 AWG	12-6 AWG
Insulating Panel Back	---	---	---
Width x Height in (mm)	2.52 (64.00) x 2.52 (64.00)	4.88 (123.83) x 4.75 (120.65)	5.25 (133.35) x 3.75 (95.25)
Depth in (mm)	4.50 (114.30)	4.50 (114.30)	4.50 (114.30)

### 65 Amp 3 Positions + OFF, 3 Pole Rotary Switch

- Allows connecting one of three different AC sources to one circuit
- Switches 3-120/240V AC sources
- Switches both lines (hot) and neutral

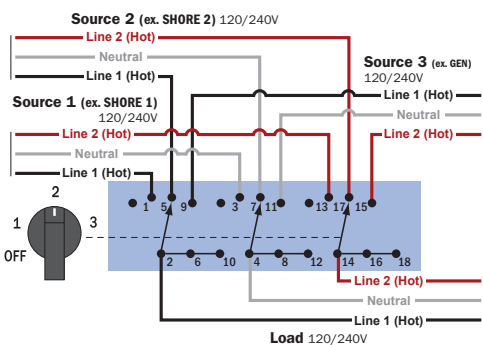

Regulatory  
CE marked  
UL listed



Part #	9077	1488	8361
Style	Rotary Switch	360 Panel System	Traditional Metal
Max. Operating V AC	600V AC	240V AC	240V AC
Wire Size Range	12-6 AWG	12-6 AWG	12-6 AWG
Insulating Panel Back	---	---	---
Width x Height in (mm)	2.52 (64.0) x 2.52 (64.0)	4.88 (123.83) x 4.75 (120.65)	5.25 (133.35) x 3.75 (95.25)
Depth in (mm)	5.50 (139.70)	5.50 (139.70)	5.50 (139.70)

## AC/DC Combination Circuit Breaker Panels

Combines AC and DC switching, circuit protection, source selection and monitoring into a single panel

### Features

- ON indicating LEDs installed in all circuit positions
- Backlit label positions
- Includes toggle switch to monitor voltage on up to three batteries
- Circuit identification label sets included
- Insulating covers are included with AC/DC 360 Panels

### Component References

- A-Series Circuit Breakers (p. 82)
- C-Series Circuit Breakers (p. 84)
- DC and AC Analog Meters (p. 140, 141)
- DC and AC Digital Multimeters (p. 146, 147) M2 Vessel System Monitor (VSM) (p. 142)
- 360 Panel System AC Insulating Rear Covers (p. 152)
- Traditional Metal Panel AC insulating Rear Covers (p. 152)
- Traditional Metal Panels include 8031 and 8030 label sets (p. 154-155)
- 360 Panels include 4206 and 4205 label sets (p. 155)



Part #	8084 / 8184*		8095 / 8195*	
Style	Traditional Metal		Traditional Metal	
Total AC Positions	Main + 6 positions		Main + 8 positions	
Total DC Positions	Main + 15 positions		Main + 29 positions	
AC Circuit Breakers	Main, 30A (7238) 3 Branch, 15A (7210)	Main, 16A (7294) 3 Branch, 8A (7299)	Main, 30A (7238) 5 Branch, 15A (7210)	Main, 16A (7294) 5 Branch, 8A (7299)
DC Circuit Breakers	Main, 100A (7250I) 9 Branch, 15A (7210)	Main, 100A (7250I) 9 Branch, 15A (7210)	Main, 100A DC (7250I) 20 Branch, 15A DC (7210)	Main, 100A (7250I) 20 Branch, 15A (7210)
AC/DC Voltage	120V AC/12V DC		120V AC/12V DC	230V AC/12V DC
Insulating Panel Back	4029 sold separately (p. 152)		--	
Actuator Style	White Toggle		White Toggle	
AC Meters	0-150V AC (9353)	0-250V AC (9354)	0-150V AC (9353), 0-50A AC (9630)	0-250V AC (9354), 0-50A AC (9630)
DC Meters	8-16V DC (8003), 0-100A DC (8017)		8-16V DC (8003), 0-100A DC (8017)	
Width x Height in (mm)	14.75 (374.65) x 10.00 (254.00)		19.50 (495.30) x 11.50 (292.10)	
Depth in (mm)	3.00 (76.20)		3.00 (76.20)	



Part #	1218 / 1219*		8413
Style	360 Panel System		Traditional Metal
Total AC Positions	Main + 6 positions		Main + 8 positions
Total DC Positions	Main + 19 positions		Main + 14 positions
AC Circuit Breakers	Main, 30A (7414) 6 Branch, 15A (7403)	Main, 16A (7412) 6 Branch, 8A (7401)	Main, 30A (7238) 8 Branch, 15A (7210)
DC Circuit Breakers	Main, 100A (7549) 19 Branch, 15A (7403)	Main, 100A (7549) 19 Branch, 15A (7403)	Main, 100A DC (7250I) 14 Branch, 15A (7210)
AC/DC Voltage	120V AC/12V DC		120V AC/12/24V DC
Insulating Panel Back	1331 Included with panel (p. 152)		--
Actuator Style	Flat Rocker		White Toggle
AC Meter, DC Meter	Digital Multimeter (8247), Digital Multimeter (8248)		M2 VSM (1850)
Width x Height in (mm)	13.63 (346.08) x 10.75 (273.05)		15.77 (400.50) x 9.25 (234.95)
Depth in (mm)	3.00 (76.20)		3.00 (76.20)

\*230 Volt (typical of Europe)



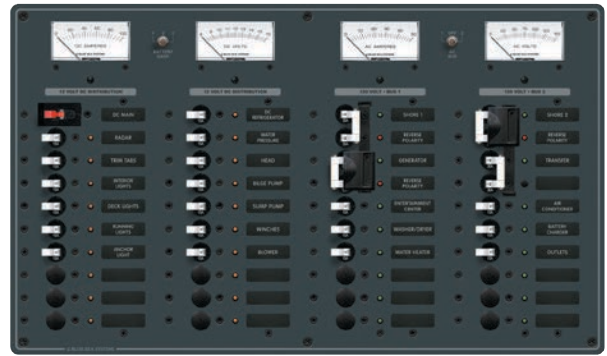

Part #	8408 / 8508*		8086 / 8186*	
Style	Traditional Metal		Traditional Metal	
Total AC Positions	Main + 6 positions		3 Sources + 12 positions + Transfer	
Total DC Positions	Main + 18 positions		Main + 19 positions	
AC Circuit Breakers	Main, 30A (7238) 3 Branch, 15A (7210)	Main, 16A (7294) 3 Branch, 8A (7299)	2 Main, 30A (7238) 1 Main, 50A (7242) 1 Transfer, 30A (7238) 6 Branch, 15A (7210)	2 Main, 16A (7294) 1 Main, 32A (7295) 1 Transfer, 16A (7294) 6 Branch, 8A (7299)
DC Circuit Breakers	Main, 100A (7250I) 12 Branch, 15A (7210)	Main, 100A (7250I) 12 Branch, 15A (7210)	Main, 100A (7250I) 13 Branch, 15A (7210)	
AC/DC Voltage	120V AC/12/24V DC	230V AC/12/24V DC	120V AC/12V DC	230V AC/12V DC
Insulating Panel Back	4029 sold separately (p. 152)		4031 sold separately (p. 152)	
Actuator Style	White Toggle		White Toggle	
AC Meters	Digital Multimeter (8247)		0-150V (9353), 0-50A (9630)	0-250V (9354), 0-50A (9630)
DC Meters	Digital Multimeter (8248)		8-16V (8003), 0-100A (8017)	
Width x Height in (mm)	15.75 (400.05) x 10.00 (254.00)		19.50 (495.30) x 11.50 (292.10)	
Depth in (mm)	4.00 (101.60)		3.00 (76.20)	

\*230 Volt (typical of Europe)





## Design and Order a Custom Panel in Three Easy Steps

Design and Order custom panels online

A Custom 360 Panel can be created in a fraction of the time required by other custom panel shops. The 360 Panel System uses an open frame to mount a broad selection of modules, allowing multiple functions to be combined in a single panel. This innovative design offers a wide choice of AC and DC panel features, can accommodate future changes, and permits rapid assembly. With options ranging from battery management to source selection, the 360 Panel System provides a wide range of design flexibility.

### 1 Launch the Panel Wizard at [panelwizard.blueseas.com](http://panelwizard.blueseas.com).

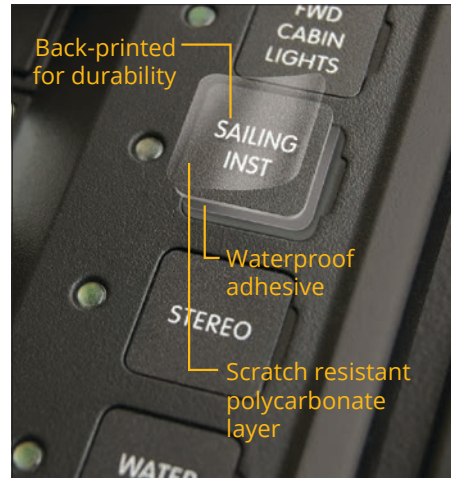

Blue Sea Systems labels are made using a scratch resistant polycarbonate material and are back-printed for durability. Custom Labels for the 360 Panel System can be ordered in any language and are available directly from Blue Sea Systems along with over 500 standard or square format labels.

### 2 Design the panel with modules, circuit breakers, and labels. The list price is updated with each change.



Completed 3 x 3 Panel



### 3 Save the panel design and request a quote.

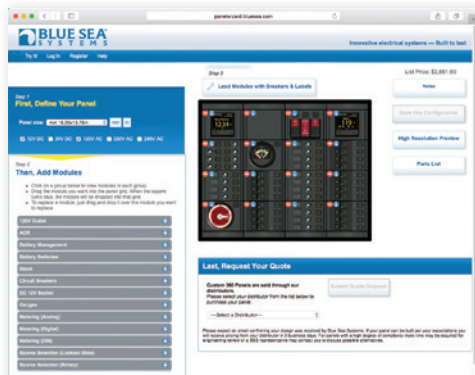





## Custom 360 Panel System

Flexible panel configurations from a single module to a 25 module panel with 100 circuit breakers.

Rows x Columns	Panel Height in (mm)	Panel Width in (mm)	Cut Out Height in (mm)	Cut Out Width in (mm)
1 x 1	4.75 (120.65)	4.88 (123.83)	3.31 (84.07)	4.38 (111.13)
2 x 1	7.75 (196.85)	4.88 (123.83)	6.31 (160.27)	4.38 (111.13)
3 x 1	10.75 (273.05)	4.88 (123.83)	9.31 (236.47)	4.38 (111.13)
4 x 1	13.75 (349.25)	4.88 (123.83)	12.31 (312.67)	4.38 (111.13)
5 x 1	16.75 (425.45)	4.88 (123.83)	15.31 (388.87)	4.38 (111.13)
1 x 2	4.75 (120.65)	9.25 (234.95)	3.31 (84.07)	8.75 (222.25)
2 x 2	7.75 (196.85)	9.25 (234.95)	6.31 (160.27)	8.75 (222.25)
3 x 2	10.75 (273.05)	9.25 (234.95)	9.31 (236.47)	8.75 (222.25)
4 x 2	13.75 (349.25)	9.25 (234.95)	12.31 (312.67)	8.75 (222.25)
5 x 2	16.75 (425.45)	9.25 (234.95)	15.31 (388.87)	8.75 (222.25)
1 x 3	4.75 (120.65)	13.63 (346.08)	3.31 (84.07)	13.13 (333.38)
2 x 3	7.75 (196.85)	13.63 (346.08)	6.31 (160.27)	13.13 (333.38)
3 x 3	10.75 (273.05)	13.63 (346.08)	9.31 (236.47)	13.13 (333.38)
4 x 3	13.75 (349.25)	13.63 (346.08)	12.31 (312.67)	13.13 (333.38)
5 x 3	16.75 (425.45)	13.63 (346.08)	15.31 (388.87)	13.13 (333.38)
1 x 4	4.75 (120.65)	18.00 (457.20)	3.31 (84.07)	17.50 (444.50)
2 x 4	7.75 (196.85)	18.00 (457.20)	6.31 (160.27)	17.50 (444.50)
3 x 4	10.75 (273.05)	18.00 (457.20)	9.31 (236.47)	17.50 (444.50)
4 x 4	13.75 (349.25)	18.00 (457.20)	12.31 (312.67)	17.50 (444.50)
5 x 4	16.75 (425.45)	18.00 (457.20)	15.31 (388.87)	17.50 (444.50)
1 x 5	4.75 (120.65)	22.38 (568.33)	3.31 (84.07)	21.88 (555.63)
2 x 5	7.75 (196.85)	22.38 (568.33)	6.31 (160.27)	21.88 (555.63)
3 x 5	10.75 (273.05)	22.38 (568.33)	9.31 (236.47)	21.88 (555.63)
4 x 5	13.75 (349.25)	22.38 (568.33)	12.31 (312.67)	21.88 (555.63)
5 x 5	16.75 (425.45)	22.38 (568.33)	15.31 (388.87)	21.88 (555.63)

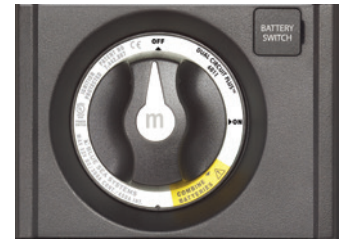

m-Series Battery Switch (p. 30)

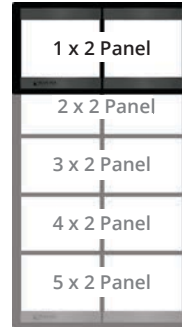

m-ACR Automatic Charging Relay (p. 46)

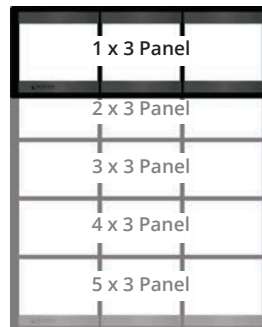

m-LVD Low Voltage Disconnect (p. 40)

## Custom BusBar Modules

Consolidate bussed terminations in a 360 Custom Panel module

- Utilize blank space in a 360 Custom Panel frame
- Ideal for DC negative, AC Neutral, and AC Ground connections
- 5 different bus bar configuration options

Panel Backs Shown Below



2x1 Panel 2722



2x1 Panel 2702



2x1 Panel 2301



2x1 Panel 2128



1x1 Panel 2701

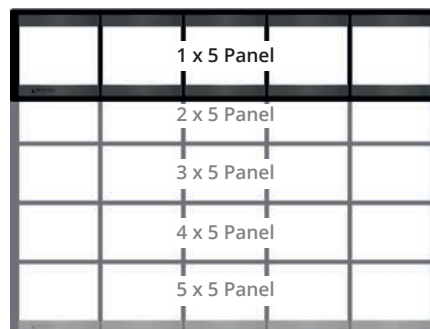
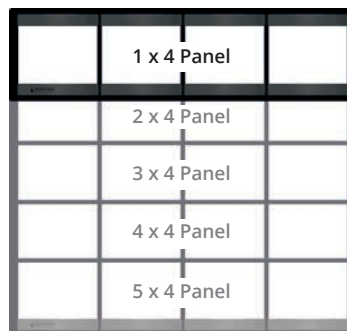

Battery Management (p. 94)



Battery Management Blank





DC Flat Rocker Circuit Breaker (p. 83)



Rotary Switch Source Selection (p. 128)

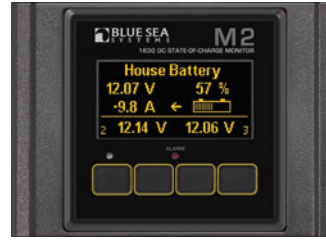

M2 OLED Meter (p. 142)



Mastervolt Smart Remote



COTS Circuit Breaker (p. 80)



Circuit Breaker Source Selection



Digital Meter (p. 146)

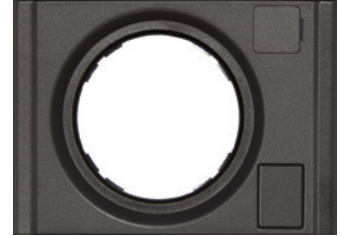

2 Inch Gauge Blank (p. 149)



Push Button Circuit Breaker with Rocker Switch (p. 75, 94)



Residual Current Circuit Breaker (p.87)



P12 Battery Charger Display (p. 20)



Socket, Dual USB Charger (p. 24, 25)



Push Button Circuit Breaker (p. 75)



European RCBO Mount



Analog Meter (p. 140)



DC Accessories (p. 24, 25, 145)



Bilge Pump



285 Series Circuit Breaker (p. 78)



120V AC Dual GFCI Outlet (p. 152)



120V AC Dual Outlet (p. 152)



AC Flat Rocker Circuit Breaker (p. 83)



Blank / Custom BusBar Module



120V AC Dual Outlet Blank

Not all 360 Panel modules or configurations are shown, reference the Blue Sea Systems Panel Wizard at [panelwizard.blueseas.com](http://panelwizard.blueseas.com)



## Custom 360 Panel System

Original equipment aboard the world's finest boats and specialty vehicles

Blue Sea Systems Custom 360 Panels are installed as original equipment aboard recreational and commercial boats, emergency response vehicles, and commercial applications.



*American Tug installs Custom 360 Panels at the helm of their model 435 boats, built in LaConner, WA.*



*EarthRoamer builds vehicles which can go beyond where the road ends. They rely on Blue Sea Systems electrical products, including the Custom 360 Panel, to keep their critical systems functioning.*



*Cutwater builds award-winning, innovative boats and specifies 360 Panels as original equipment.*







*Black Cove Yachts builds boats which use Blue Sea Systems products including Custom 360 Panels aboard the BC37.*

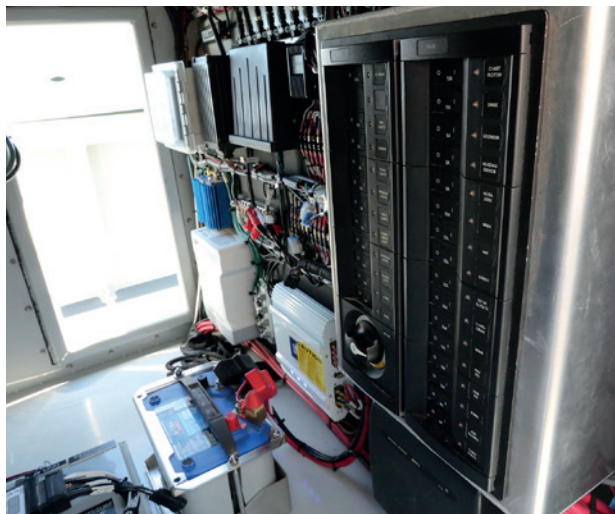

*Metal Shark builds custom aluminum boats for government agencies. The Custom 360 Panel is housed inside the center console and distributes power to critical loads aboard the Relentless 28.*



# METERS

## Analog



140

AC and DC Meters with backlighting for low light conditions.

## M2 OLED Digital



142

Measures essential electrical system parameters with adjustable alarms and an auto-dimming display.

## Mini OLED Digital



145

Monitors key functions on a bright, waterproof, daylight readable screen.

## Digital



146

Monitors key AC and DC functions.



## Direct Current (DC) Monitoring

Direct Current is typically derived from batteries, but can also be produced by converting AC Current to DC Current using a battery charger. Typically the values measured are Volts, Amps and Amp-Hours (State-of-Charge).



# METERS

## Mini Clamp Multimeter



145

Compact and feature-rich AC/DC Multimeter simplifies diagnosis of marine electrical problems.

## DC Shunts



149

For use with DC Ammeters.

## Temperature Sensors



149

For use with the M2 OLED and Mini OLED Meters.

## AC Transformers

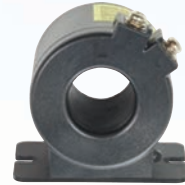

149

For use with AC Ammeters.



## Alternating Current (AC) Monitoring

Alternating Current, known more typically as household current, can also be produced by converting DC current to AC current through the use of an inverter. Typically the values measured are Volts, Amps, Watts, and Frequency.

## DC Analog Meters

Meters with backlighting for low light conditions

- Includes appropriate external DC shunt (p. 149) when required
- Backlit meter face (separate 12V or 24V DC backlight connections)



8028



8003

Part #	Function	Operating Amps (Meter)	Operating Amps (Backlight)	Connection
8028	Micro Voltmeter 8–16V DC	1 mA at full scale	16 mA@12V DC, 20 mA@24V DC	2 wire, 3 connections for backlight
8003	Standard Voltmeter 8–16V DC	1 mA at full scale	16 mA@12V DC, 20 mA@24V DC	2 wire, 3 connections for backlight
8240	Standard Voltmeter 18–32V DC	1 mA at full scale	16 mA@12V DC, 20 mA@24V DC	2 wire, 3 connections for backlight



8041



8005

Part #	Function	Operating Amps (Meter)	Operating Amps (Backlight)	Shunt Type	Connection
8041	Micro Ammeter 0–50A DC	1 mA at full scale	16 mA@12V DC, 20 mA@24V DC	External—50 mV at full scale	2 wire from shunt, 3 connections for backlight
8005	Standard Ammeter 0–25A DC	1 mA at full scale	16 mA@12V DC, 20 mA@24V DC	Internal	2 wire inline, 3 connections for backlight
8022	Standard Ammeter 0–50A DC	1 mA at full scale	16 mA@12V DC, 20 mA@24V DC	External—50 mV at full scale	2 wire from shunt, 3 connections for backlight
8017	Standard Ammeter 0–100A DC	1 mA at full scale	16 mA@12V DC, 20 mA@24V DC	External—50 mV at full scale	2 wire from shunt, 3 connections for backlight
8018	Standard Ammeter 0–150A DC	1 mA at full scale	16 mA@12V DC, 20 mA@24V DC	External—50 mV at full scale	2 wire from shunt, 3 connections for backlight
8019	Standard Ammeter 0–200A DC	1 mA at full scale	16 mA@12V DC, 20 mA@24V DC	External—50 mV at full scale	2 wire from shunt, 3 connections for backlight



8254



8253

Part #	Function	Shunt Type	Connection	Meter Face Size in (mm)
8252*	Zero Center Ammeter 50–0–50A DC	External—50 mV at full scale	2 wire from shunt, 3 connections for backlight	2.75 (69.85)
8253*	Zero Center Ammeter 100–0–100A DC	External—50 mV at full scale	2 wire from shunt, 3 connections for backlight	2.75 (69.85)

\*Meters read both discharge and charge current

## DC Analog Voltmeter Panels

Enables voltage monitoring on up to 3 battery banks with one analog meter

- Includes standard 8003 DC Analog Voltmeter
- Displays voltage from 8V–16V DC
- 3 position switch for multiple battery banks



8015

**Traditional Metal**

5.25" x 3.75" (133.35mm x 95.25mm)



1473

**360 Panel System**

4.88" x 4.75" (123.83mm x 120.65mm)



# AC Analog Meters

Meters with backlighting for low light conditions

- Includes appropriate external transformer (p. 149) when required
- Backlit meter face (separate 12V or 24V DC backlight connections)



8244



9353

Part #	Function	Operating Amps (Meter)	Operating Amps (Backlight)	Connection
8244	Micro Voltmeter 0-150V AC	1 mA at full scale	16 mA@12V DC, 20 mA@24V DC	2 wire to AC hot and neutral, 3 connections for backlight
8245	Micro Voltmeter 0-250V AC	1 mA at full scale	16 mA@12V DC, 20 mA@24V DC	2 wire to AC hot and neutral, 3 connections for backlight
9353	Standard Voltmeter 0-150V AC	1 mA at full scale	16 mA@12V DC, 20 mA@24V DC	2 wire to AC hot and neutral, 3 connections for backlight
9354	Standard Voltmeter 0-250V AC	1 mA at full scale	16 mA@12V DC, 20 mA@24V DC	2 wire to AC hot and neutral, 3 connections for backlight



8246



9630

Part #	Function	Operating Amps (Meter)	Operating Amps (Backlight)	Connection
8246	Micro Ammeter 0-50A AC	50 mA at full scale	16 mA@12V DC, 20 mA@24V DC	2 wire from coil slipped over wire to be measured, 3 connections for backlight
9630	Standard Ammeter 0-50A AC	50 mA at full scale	16 mA@12V DC, 20 mA@24V DC	2 wire from coil slipped over wire to be measured, 3 connections for backlight
8258	Standard Ammeter 0-100A AC	50 mA at full scale	16 mA@12V DC, 20 mA@24V DC	2 wire from coil slipped over wire to be measured, 3 connections for backlight

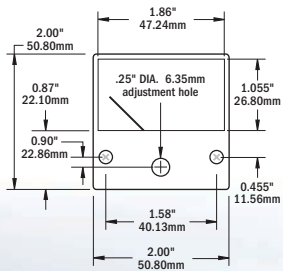

Micro Meter

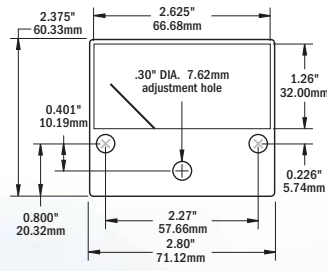

Standard Meter

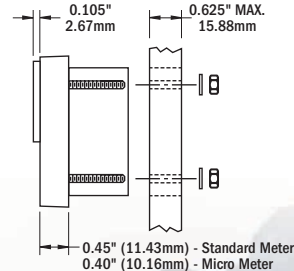

Surface Mount

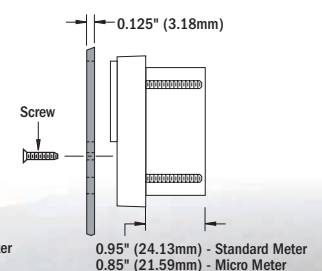

Panel Mount



## M2 OLED Digital Meters

The M2 Organic LED Digital Monitor measures essential electrical system parameters with adjustable alarms and an auto-dimming display. The M2 Monitors include a MOSFET External Circuit Relay (ECR) which can be used to control external circuits based on any value measured by the M2.

- Auto-dimming, bright Organic LED display is easy to read 80dB alarm on all models
- Isolated 500mA MOSFET relay
- Includes external DC Shunt or AC Current Transformer when required

Display Size	55mm x 28mm
Power Supply Voltage	7V-70V DC
Power Consumption	0.3W-1.0W*
Regulatory	Monitor face is IP66 - protected against powerful water jet when installed according to instructions (see inside back cover)

\* Variable with voltage, display intensity, and sleep mode

### Mounting Options

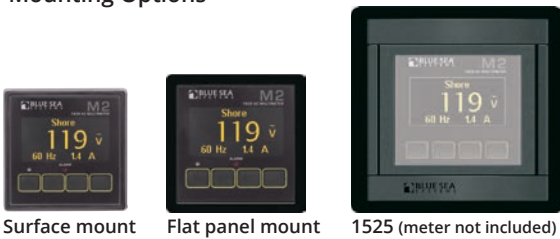

Part #	Description	Width in (mm)	Height in (mm)
1525	360 Blank Panel - M2 OLED	4.88 (123.83)	4.75 (120.65)

### Dimensions

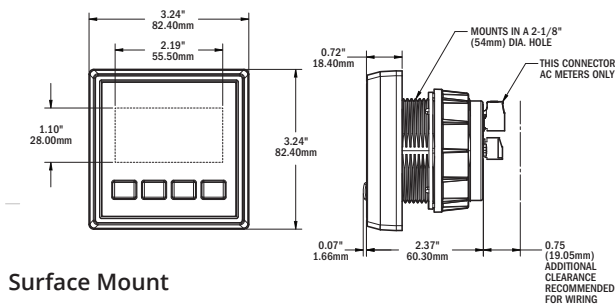

### Surface Mount

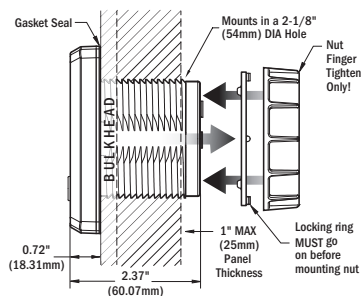

### Related Products



AC Current Transformer page 149

ML-Series Remote Battery Switches page 43

Temperature Sensor page 149

Floyd Bell Turbo Series Alarm page 152

DC Shunts page 149



See page 144 for additional information



### Vessel Systems Monitor

Part #	1850
Meter Type	AC, DC, Tank, Bilge
Functions	Performs comprehensive monitoring of four critical systems. NMEA 2000 Certified
<b>DC Voltage</b>	
Nominal	12V, 24V, 36V, 48V
Range	0-70V
Resolution	0.01V DC
Accuracy	+/- 1%
Alarm Activation	High / Low Voltage
<b>DC Current</b>	
Shunt included	8255 (500A / 50mV)
Range	-500A to 500A
Accuracy	+/- 2%
Resolution (100 to 500)	1A
Resolution (0.0 to 99.9)	0.1A
Alarm Activation	High Current, Low Battery
<b>AC Voltage</b>	
Range	40V-300V AC (RMS)
Accuracy	+/- 1%
Resolution	1V AC
Alarm Activation	High / Low Voltage
<b>AC Current</b>	
Range	0-150A (300A optional)**
Accuracy	+/- 2%
Resolution	1A
Resolution	0.1A
Transformer	8256 (150A / 50mA)
Alarm Activation	High Current
<b>Frequency</b>	
Range	40Hz-90Hz
Resolution	1Hz
Alarm Activation	High / Low Frequency
<b>Power</b>	
Range	0W-45kW
Resolution (0W-9990W)	10W
Resolution (10kW-45kW)	0.1kW
<b>Tanks/Bilge</b>	
Senders	European: 10-180 Ω VDO, North American: 240-33 Ω Teleflex, Blue Sea Systems Ultrasonic (1810, 1811) 5V Sender, Custom
Custom Tank Shapes	Auto Calibration
Inputs	2
Tank Alarm Activation	High / Low Levels
Bilge Alarm Activation	Run time per hour, Cycles per 24-hour

\*\* Will achieve 300A with an optional current transformer 1829



DC Meters			AC Meters		Tank	Bilge
1830	1832	1833	1837	1838	1839	1842
DC Multimeter w/SoC	DC Ammeter	DC Voltmeter	AC Voltmeter	AC Multimeter	Tank	Bilge
Monitors state-of-charge on one battery bank and voltage on three battery banks	Monitors current on two circuits	Monitors the voltage on up to four battery banks	Monitors voltage on two circuits or both legs of 120/240V	Monitors voltage, current, frequency, and power on two circuits or both legs of 120/240V	Monitors up to 4 tanks	Monitors up to 4 bilges
12V, 24V, 36V, 48V	--	12V, 24V, 36V, 48V	--	--	--	--
0-70V	--	0-70V	--	--	--	--
0.01V DC	--	0.01V DC	--	--	--	--
+/- 1%	--	+/- 1%	--	--	--	--
High / Low Voltage	--	High / Low Voltage	--	--	--	--
8255 (500A / 50mV)	8255 (500A / 50mV)	--	--	--	--	--
-500A to 500A	-500A to 500A	--	--	--	--	--
+/- 2%	+/- 2%	--	--	--	--	--
1A	1A	--	--	--	--	--
0.1A	0.1A	--	--	--	--	--
High Current, Low Battery	High Current	--	--	--	--	--
--	--	--	40V-300V AC (RMS)	40V-300V AC (RMS)	--	--
--	--	--	+/- 1%	+/- 1%	--	--
--	--	--	1V AC	1V AC	--	--
--	--	--	High / Low Voltage	High / Low Voltage	--	--
--	--	--	--	0-150A (300A optional)**	--	--
--	--	--	--	+/- 2%	--	--
--	--	--	--	1A	--	--
--	--	--	--	0.1A	--	--
--	--	--	--	8256 (150A / 50mA)	--	--
--	--	--	--	High Current	--	--
--	--	--	--	40Hz-90Hz	--	--
--	--	--	--	1Hz	--	--
--	--	--	--	High / Low Frequency	--	--
--	--	--	--	0W-45kW	--	--
--	--	--	--	10W	--	--
--	--	--	--	0.1kW	--	--
--	--	--	--	--	North American, 240Ω-33Ω European, 10Ω-180Ω Blue Sea Systems Ultrasonic (1810, 1811) Custom Ranges to 300Ω	Works with bilge pumps with external float switches or automatic bilge pumps that indicate ON status via a 12V output
--	--	--	--	--	Auto Calibration	--
--	--	--	--	--	4	4
--	--	--	--	--	High / Low Levels	--
--	--	--	--	--	--	Run time per hour, Cycles per 24-hour



## M2 OLED Vessel Systems Monitor (M2 VSM)

Performs comprehensive monitoring of four critical systems in one compact organic LED digital monitor

### DC System Monitoring (up to two batteries)

One input monitors the DC voltage, state-of-charge, current for one battery bank and another input monitors the voltage of an additional battery bank. Alarms include high and low voltage, high current, and low battery.

### AC System Monitoring

The VSM monitors a single AC voltage, current, and frequency. Alarms include high and low voltage, high current, and high and low frequency.

### Bilge & Tank Monitoring

The M2 VSM has two inputs that can be configured as a bilge or tank monitor. When configured as a bilge input, monitoring functions include pump active, cycle count in the last 24-hours, average cycles in a typical 24-hour period, and total cycles. High alarms can be set for both the minutes of run time in the last hour as well as the number or cycle counts in the last 24-hours. When configured as a tank input, tank status can be represented in both capacity (gallons or liters) or as a percentage of capacity. Custom tank shapes can be auto-calibrated or programmed. Both high and low level alarms can be set for all tanks.

### 1850 Retail Packaging Includes:

head unit, display cover, surface mount bezel, surface mount gasket, DC Current Shunt 8255, AC Current Transformer 8256, connectors, mounting screws and screw driver.

### Tank Senders Supported:

- 10–180 Ω VDO
- 240–33 Ω Teleflex
- Blue Sea Systems Ultrasonic Tank Senders (sold separately)
  - For diesel, water, or waste 1810 (32" tank depth)
  - For gasoline 1811 (24" tank depth)

See page 142 for specifications

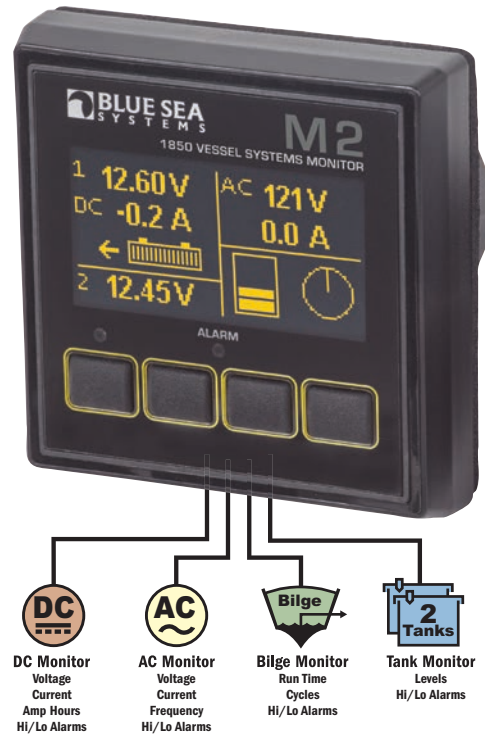

Part #	Description
1850	M2 VSM

### Connection Table

System	Inputs	Functions
DC	2	DC Voltage Battery 1, State-of-Charge, & Current DC Voltage Battery 2
AC	1	AC Voltage, Current, & Frequency
Auxiliary	2	Auxiliary 1: Tank or Bilge Auxiliary 2: Tank or Bilge

## TECH TIP

### State-of-Charge

#### Battery State-of-Charge (SoC)

Knowing the State-of-Charge of your battery is like knowing the amount of fuel in your gas tank. To avoid getting stranded with a dead battery, accurate battery bank monitoring is essential.

**Voltmeter Method**—Voltage can be used to measure the SoC of your battery. The difference from a fully charged battery to a fully discharged battery is only 1.0V in a 12V system, so the meter must have good resolution and accuracy. This method is generally sufficient to monitor batteries which experience intermittent use, such as starter or thruster batteries. However, a battery must not have been charged or discharged for over 12 hours for this measurement to be trustworthy. This makes the Voltmeter Method unsuitable for monitoring house batteries which charge and discharge often.

**Amp-Hour Method**—A convenient and accurate way to measure SoC is with an Amp-Hour Monitor. This is a complex calculation of the energy available, energy consumed, and energy returned to the battery during charging. SoC is commonly expressed as a percent of amp-hours remaining until the battery is empty, but can also be expressed as amp-hours used, amp-hours remaining, or time remaining. The advantage of this method is that it works well for batteries in a constant state of charge and discharge.

## Ultrasonic Tank Senders

Ultrasonic technology used to measure volume



Part #	Description
1810	32" Diesel, Water, Waste tank sender
1811	24" Gasoline tank sender

### Mini OLED Meters

Monitors essential electrical system parameters, temperature, and tank levels, on a bright, waterproof, daylight readable OLED screen

- Compact size enables mounting in any convenient location
- Now available with yellow or blue OLED screens
- Reverse polarity protected
- Mounts in a common 1-1/8 in hole

Cutout Dimensions	1-1/8" (29 mm) diameter
Lifecycles	Blue OLED: 10,000 hours Yellow OLED: 100,000 hours

Part #	1733 1733200	1732 1732200	1741 1741200	1739 1739200
Description	Voltmeter	Ammeter	Temp Meter	Tank Meter
Nominal Voltage	12V / 24V DC	12V / 24V DC	12V / 24V DC	12V / 24V DC
Input Voltage	8V-36V DC	8V-36V DC	8V-36V DC	8V-36V DC
Max. Operating Current	15mA	15mA	10mA	17mA
Resolution	0.01V DC	0.1A	1°F or 1°C	5%
Accuracy	+/- 1%	+/- 2%	+/- 1.25%	--
Intermittent: 5 min.	--	110A	--	--
Cranking: 30 sec.	--	175A	--	--
DC Shunt (included)	--	9230 (100A/50mV)	--	--
Temp Sensor (included)	--	--	1820	--
Monitors	8V -36V DC	-100A -100A DC	-40°F -175°F or (-40°C-80°C) *	Tank Level
Compatible Senders	--	--	--	North American: 240-33Ω European: 10-180Ω
Regulatory	CE marked, IP66 - protected against powerful water jets (see inside back cover)			

\* -40°F-250°F or (-40°C-120°C) with sensor 1821 (Optional)



1733200 Blue OLED  
1733 Yellow OLED



1741200 Blue OLED  
1741 Yellow OLED



1732200 Blue OLED  
1732 Yellow OLED



1739200 Blue OLED  
1739 Yellow OLED

Related Products



DC Shunts page 149



Temperature Sensor page 149



Water-Resistant Accessory Panels page 26

### Mini Clamp Multimeter

Compact and feature-rich AC/DC Multimeter simplifies diagnosis of marine electrical problems

- Clamp allows measurement of AC and DC current in wires without disturbing the circuits or contacting live terminals
- Compact size allows comfortable one hand operation, portability, and access to confined areas
- Auto range simplifies operation by automatically selecting the range that best fits the data
- Additional functions include: Data Hold, Overload Display, and AutoPower-Off
- True RMS AC measurement is accurate for normal sine wave and modified sine wave inverter output

Part #	8110
AC Amps	0.01-400A
AC Volts	0.001-600V
DC Amps	0.01-400A
DC Volts	0.001-600V
Resistance/Continuity Alarm	0.1-40MΩ
Measurement Resolution	4300 counts
Regulatory	CE marked, CAT III, 600 Volts



Includes test leads and carrying case

## DC Digital Meters

Monitors key DC functions

- Large, bright LED characters
- Three levels of brightness
- Splash-proof front
- Easy to surface mount in a 2" round hole



Display Character Size	9/16"
Power Supply Voltage	8-50V DC
Max. Power Consumption	1.00W*
Min. Power Consumption	0.60W*

### Digital Meter Front Panel Mount

Surface mounting features a finger nut and locking ring for quick and easy installation into a 2.00" (50.8mm) diameter hole.

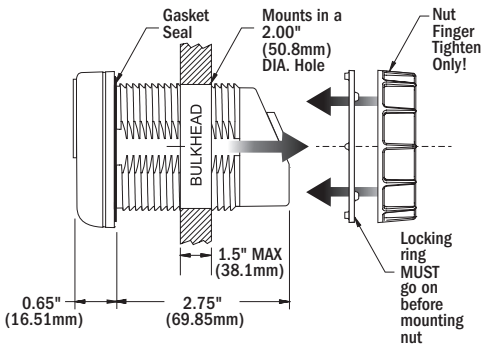

### Dimensions

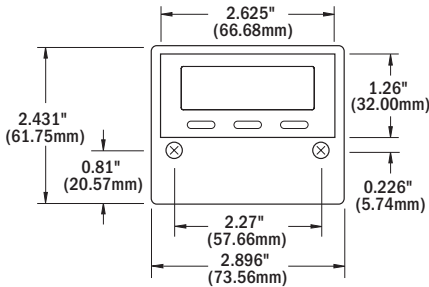

8248  
DC Multimeter with Alarm

Voltage Measurement	
Range	0-60V DC
Resolution	0.01V DC
Accuracy (% of Reading)	± 0.5%**
Current Measurement	
Shunt (Included)	500A/50mV
Range	± 500A DC
Resolution (-100 to -500)	1A DC
Resolution (-99.9 to +500)	0.1A DC
Accuracy (% of Reading)	± 0.5%**



8235  
DC Voltmeter

Voltage Measurement	
Range	0-60V DC
Resolution	0.01V DC
Accuracy (% of Reading)	± 0.5%**



8251  
DC Voltmeter with Alarm

Voltage Measurement	
Range	0-60V DC
Resolution	0.01V DC
Accuracy (% of Reading)	± 0.5%**



8236  
DC Ammeter

Current Measurement	
Shunt (Included)	500A/50mV
Range	± 500A DC
Resolution (-100 to -500)	1A DC
Resolution (-99.9 to +500)	0.1A DC
Accuracy (% of Reading)	± 0.5%**

Part #	Description	Measurement	Sleep Mode	Alarms
8248	DC Multimeter with Alarm	Voltage, Current	Programmable	High and low voltage
8235	DC Voltmeter	Voltage	Manual	--
8251	DC Voltmeter with Alarm	Voltage	Programmable	High and low voltage
8236	DC Ammeter	Current	Manual	High and low voltage

\* Variable with voltage, display intensity, segments illuminated, and sleep mode  
 \*\*± 1 (Least Significant Digit)

## DC Digital Voltmeter Panels

Enables voltage monitoring on up to 3 battery banks with one digital meter

- Includes 8235 DC Digital Voltmeter
- 4 digit LED display—Displays voltage from 0-60V DC
- 3 position switch for multiple battery banks

Part #	Width in (mm)	Height in (mm)
8051	5.25 (133.35)	3.75 (95.25)
1474	4.88 (123.83)	4.75 (120.65)



8051



1474



## AC Digital Meters

Monitors key AC functions

- Large, bright LED characters
- Three levels of brightness
- Splash-proof front
- Easy to surface mount in a 2" round hole



Display Character Size	9/16"
Input Voltage	80-249V DC
Max. Power Consumption	1.00W*
Standby Power	0.60W*



8238  
AC Ammeter

Current Measurement	
Current Transformer	150A/50mA
Range 1 (Resolution 0.01A)	0.00-9.99A AC (RMS)
Range 2 (Resolution 0.1A)	10.0-150.0A AC (RMS)
Accuracy (% of Reading)	± 3.0%***



8237  
AC Voltmeter

Voltage Measurement	
Range	80-249V AC*
Resolution	0.1V AC
Accuracy (% of Reading)	
90-249V AC (RMS)	± 2.0%***
70-90V AC (RMS)	± 5.0%***

Part #	Description	Measurement	Sleep Mode	Alarms
8238	AC Ammeter	Current	Manual	--
8247	AC Multimeter with Alarm	Voltage, Current, Frequency, Power	Programmable	High and low voltage, High current
8237	AC Voltmeter	Voltage	Manual	--



8247  
AC Multimeter with Alarm

Voltage Measurement	
Range	80-249V AC*
Resolution	0.1V AC
Accuracy (% of Reading)	
90-249V AC (RMS)	± 2.0%***
70-90V AC (RMS)	± 5.0%***
Current Measurement	
Current Transformer	150A/50mA
Range 1 (Resolution 0.01A)	0.00-9.99A AC (RMS)
Range 2 (Resolution 0.1A)	10.0-150.0A AC (RMS)
Accuracy (% of Reading)	± 3.0%***
Frequency Measurement	
Range	40-90Hz
Resolution	0.1Hz
Accuracy (% of Reading) Calibrated with sine wave input	± 0.1%***
Power Measurement	
Range 1 (Resolution 10W)	0-9990W
Range 2 (Resolution 0.1kW)	10-45kW
Accuracy (% of Reading)	± 5%***

Included Current Transformer 8256 (page 149)

## 120/240V AC Digital Meter Mounting Panel

For monitoring 120/240V AC Systems

- Use with AC Digital Multimeter 8247 for monitoring 120/240V AC Systems
- Monitor Line 1 or Line 2 to Neutral and Line 1 to Line 2 voltages
- Includes two additional Current Transformers 8256 (p.page 149) and mounting screws

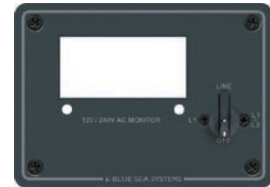

8410 (meter not included)  
120V/240V AC Digital Meter Blank Panel

Part #	Width in (mm)	Height in (mm)
8410	5.25 (133.35)	3.75 (95.25)

## Analog and Digital Meter Mounting Panels

Provides an easy method of mounting meters

- Panel mounts standard 2-3/4" Analog or Digital Meters
- Includes mounting screws and center adjustment hole plug



8013 (meter not included)  
Accepts (1) 2-3/4" Analog or Digital Meter



1475 (meter not included)  
Accepts (1) 2-3/4" Analog or Digital Meter

Part #	Width in (mm)	Height in (mm)
1475	4.88 (123.83)	4.75 (120.65)
8013	5.25 (133.35)	3.75 (95.25)

\* For 120 & 240 Volt AC single phase systems

\*\* Variable with voltage, display intensity, segments illuminated, and sleep mode

\*\*\* ± 5 LSD (Least Significant Digit)

# Meter Comparison



M2 OLED	Digital		Mini OLED	Analog Micro	Analog Standard	
DC Voltmeter	DC Voltmeter		DC Voltmeters	DC Voltmeter	DC Voltmeter	
page 142	page 146		page 145	page 140	page 140	
1833	8235	8251*	1733 & 1733200	8028	8003	8240
0-70V	0-60V		8-36V	8-16V	8-16V	18-32V
4 channels	1 channel		1 channel	1 channel	1 channel	

\* with alarm



M2 OLED	Digital	Analog Micro			Analog Standard		M2 OLED	Digital	Mini OLED
AC Voltmeter	AC Voltmeter	AC Voltmeters			AC Voltmeters		AC Voltmeter	AC Voltmeter	AC Voltmeter
page 142	page 147	page 141			page 141		page 142	page 146	page 145
1837	8237	8244	8245	8246	9353	9354	1832	8236	1732 & 1732200
50-250V	80-249V	0-150V	0-250V	0-50V	0-150V	0-250V	±500A	±500A	±100A
2 channels	1 channel	1 channel			1 channel		2 channels	1 channel	1 channel



Analog Micro	Analog Standard							
DC Ammeter	DC Ammeters							
page 140	page 140							
8041	8005	8022	8017	8018	8019	8252	8253	
0-50A	0-25A	0-50A	0-100A	0-150A	0-200A	50-0-50A	100-0-100A	
	1 channel							



Digital	Analog Standard	M2 OLED	M2 OLED	Mini OLED	Mini OLED
AC Ammeter	AC Ammeter	Bilge Monitor	Tank Monitor	Tank Monitors	Temperature Meters
page 147	page 141	page 142	page 142	page 145	page 145
8238	9630	8258	1842	1839	1739 & 1739200
0-150A	0-50A	0-100A	Up to 4 bilges	Up to 4 tanks	1 tank
1 channel	1 channel		4 channels	4 channels	1 channel



M2 OLED	Digital	M2 OLED	Digital	M2 OLED VSM	Mini Clamp
DC Multimeter w/SoC	DC Multimeter	AC Multimeter	AC Multimeter	AC/DC Multimeter	AC/DC Multimeter
page 142	page 146	page 142	page 147	page 142	page 145
1830	8248	1838	8247	1850	8110
12V, 24V, 36V, 48V 7-70V, ±500A	0-60V ±500A	50-300V, 0-150A, 40-90Hz, 0-45kW	80-249V, 0-150A 40-90Hz, 0-45kW	7-70V DC, ± 500A DC 40-300V AC, 0-150A AC Bilge, Tank, State-of-Charge	0.01-400A AC, 0.001-600V AC, 0.01-400A DC, 0.001-600V DC
3 x V DC channels 1 x A DC channel 1 x SoC channel	1 x V DC channel 1 x A DC channel	2 x V AC channels 2 x A AC channels	1 x V AC channel 1 x A AC channel	up to 5 channels	-

## DC Shunts

### Use with DC Ammeters

- For continuous operation, it is recommended that shunts not be run at more than two-thirds (66%) the rated current under normal conditions

Shunt Type	Resistive
Full Scale	50 mV
Amperage Max. Operating	66% of Rated Current
Amperage Int. (5 min.)	100% - Full scale rating
Amperage Int. (3 sec.)	300% - Full scale rating

Part #	For Use With:	Ratio
9228	Analog Ammeter	50A DC/50mV DC
9230	Analog Ammeter	100A DC/50mV DC
9231	Analog Ammeter	150A DC/50mV DC
9233	Analog Ammeter	200A DC/50mV DC
8255	Digital Ammeter	500A DC/50mV DC



9228



9233



8255

## Gauge Panel

### For Round Gauges



(Gauge not included)

Part #	1510
Width in (mm)	4.88 (123.83)
Height in (mm)	4.75 (120.65)
Depth in (mm)	0.50 (12.70)

## Temperature Sensors

### Use with the P12 Battery Charger, M2 OLED Meters, M2 VSM, VSM 422, and Mini OLED Meters

- Installs with double-sided tape

Part #	1820	1821
Wire Size	16 AWG	16 AWG
Wire Length	12" (31 cm)	18" (46 cm)
IP Rating	IP68 Submersible	IP65 Non-submersible
Temperature Range	-40°F to 175°F (-40°C to 80°C)	-40°F to 300°F (-40°C to 150°C)



1820



1821

## AC Current Transformers

### Use with AC Ammeters

Part #	For Use With:	Ratio
8073	Analog Ammeter	50A AC/50mA AC
8257	Analog Ammeter	100A AC/50mA AC
8256	Digital, M2 Ammeter & M2 VSM	150A AC/50mA AC
1829	M2 Ammeter	300A AC/50mA AC



1829



8073

## Related Products



2719 Enclosure  
page 102



Mini OLED  
Digital Meters  
page 145



M2 OLED  
Digital Meters  
page 142



Digital Meters  
page 146



Mini  
Analog Meters  
page 140



Standard  
Analog Meters  
page 140



# ACCESSORIES

## Floyd Bell Turbo Alarm



152

Adjustable extra loud volume and beep tone audibly alerts operator.

## Insulating Back Covers



152

Provides electrical insulation for exposed panel backs.

## GFCI and 120V AC Dual Outlet



153

Provides a 360 Panel System platform for mounting equipment, switching, and monitoring functions.

## LED Indicators



153

Easy to install, available in an assortment of colors, and provide visual indication of power or alerts.





# ACCESSORIES

## Lockout Slides



153

Enables safe management of multiple AC sources which use double or triple pole circuit breakers.

## Toggle Guard



153

Protects toggle circuit breakers from accidental switching.

## Labels

CABIN LIGHTS

CABIN LIGHTS



CABIN LIGHTS

154

Over 500 standard labels are available in large, small, square and round formats for use on Blue Sea Systems products including fuse blocks, busbar insulating covers, panels, switches and Contura switches. Custom Labels are available and can be easily ordered online at [www.blueseasystems.com/labels](http://www.blueseasystems.com/labels).



**Blue Sea Systems offers a range of panel accessories which support four panel styles.**

ABYC standards mandate isolation of AC and DC components on combination panels. Stackable, screw-down covers protect AC components from coming into contact with tools, personnel, and DC wiring. Traditional Metal and 360 Panel System accessories include back covers for panels.

## Floyd Bell Turbo Series DC Audible Alarm

Extra loud beep tone alerts operator



- Rotating bezel adjusts alarm volume
- Threaded attachment ring
- Fits 1 inch round aperture

Part #	1070
Voltage Nominal	12V / 24V DC
Operating Voltage	5-30V DC
Operating Current	5 mA @ 5V DC 25 mA @ 30V DC
Sound Level @ 25°C and 24"	85±5 dB(A) @ 5V DC 103±5 dB(A) @ 30V DC
Operating Frequency	2900 ± 250 Hz
Terminals	Male 1/4" Quick Connect
Regulatory	IP68 - Withstands water submergence and dust exposure, UL Recognized

### Related Product



m-LVD Low Voltage Disconnect page 40

## 360 Panel Insulating Back Covers

Provides electrical insulation for exposed panel backs

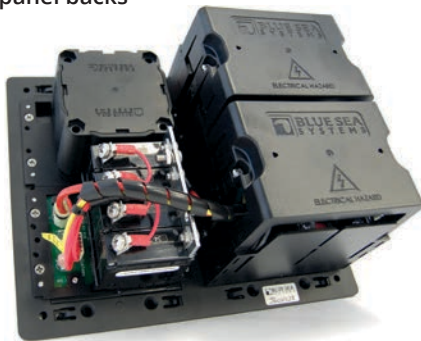

- Isolation of AC from DC components
- Meets ABYC safety requirements for panels with combined AC and DC loads
- Modular design of interlocking pieces can be stacked to accommodate large components
- Cover breakouts allow wire access in any direction

Part #	1331
Modules	Cover for 1 module
Material	UL 94-V0 Polycarbonate
Hardware	2 qty. #6 Phillips-drive sheet metal screws, 4 qty. #8-32 x 0.5" Phillips-drive machine screws with lock washers

## AC Insulating Back Covers

Provides electrical insulation for many of Blue Sea Systems Traditional Metal circuit breaker panels



4029 installed on 8084 AC/DC Circuit Breaker Panel (p. 130)

- Isolation of panel AC protection from DC components
- Provides mechanical protection for panel backs
- Lightweight material is easily drilled for wire pass-through
- Meet ABYC safety requirements
- 4029 and 4031—Used only for Blue Sea Systems toggle panels

Material UL-94-V0 Thermoplastic

Part #	Description
4026	Cover for 5-1/4" x 3-3/4"
4027	Cover for 5-1/4" x 7-1/2"
4028	Cover for 10-1/2" x 7-1/2"
4029	Cover for 1 Column x 8 Position + Meter
4031	Cover for 2 Column x 10 Position + Meter

## 360 Panel 12V to 24V DC Conversion Kit

Converts indicator LEDs from 12V DC to 24V DC

- Requires one kit per 12V DC circuit breaker module
- Includes wire harness and panel identification label



Part #	4113
Description	360 Panel 12V to 24V DC Conversion Kit

## 360 Panels

Provides a 360 Panel System platform for mounting equipment, switching, and monitoring functions

- 1518 is suitable for mounting accessories and for pad printing
- 1499 provides continuous ground fault protection and auto-monitoring



1518



1499

Part #	Panel Description	Width in (mm)	Height in (mm)	Depth in (mm)
1518	Blank	4.88 (123.83)	4.75 (120.65)	0.50 (12.70)
1479	120V AC Dual Outlet	4.88 (123.83)	4.75 (120.65)	1.00 (25.40)
1479100	Blank Outlet	4.88 (123.83)	4.75 (120.65)	0.50 (12.70)
1499	20A, 120V AC GFCI Dual Outlet	4.88 (123.83)	4.75 (120.65)	1.00 (25.40)



### Marine Grade Dual GFCI Receptacle

Weather and tamper resistant ground fault circuit interrupter reduces the risk of fire and shock hazards

- Delivers continuous ground fault protection
- Automatically self-tests to ensure it can respond feedback
- Status indicator light provides simple, intuitive feedback
- Designed with stainless steel hardware
- Designed with UV stabilized plastics



Part #	1698
Color	White
Voltage	125V AC
Amperage	20A
Trip Level	Class A, 5Ma ± 1Ma
Regulatory	UL 943 Class A, UL 498, CSA C22.2-144.1 & 42

Related Product



20A, 120V AC GFCI Dual Outlet 360 Panel, page 152

### LED Indicator Lights

Directly replaces LEDs used in Blue Sea Systems Traditional Metal circuit breaker panels



- Simple push-in installation mounts in any thickness material
- Useful as general indicator and alarm lights

Mounting Hole Size	11/64" (4.36 mm)
Wire Gauge	26 AWG

Part #	Color	Nominal Voltage	Current (mA)	Power Consumption (mW)	Circuit
8033	Amber	12 / 24V DC	1.5 @ 12V 3.1 @ 24V	19 @ 12V 75 @ 24V	Resistor
8171	Red	12 / 24V DC	1.5 @ 12V 3.2 @ 24V	19 @ 12V 77 @ 24V	Resistor
8172	Green	12 / 24V DC	1.5 @ 12V 3.0 @ 24V	19 @ 12V 73 @ 24V	Resistor
8169	Amber	120V AC	2.3 @ 120V	278 @ 120V	Resistor
8066	Red	120V AC	2.7 @ 120V	326 @ 120V	Resistor
8034	Green	120V AC	2.3 @ 120V	278 @ 120V	Resistor
8167	Amber	250V AC	1.1 @ 250V	276 @ 250V	Resistor + Diode
8166	Red	250V AC	1.1 @ 250V	276 @ 250V	Resistor + Diode
8134	Green	250V AC	1.1 @ 250V	276 @ 250V	Resistor + Diode

### C-Series Circuit Breaker Lockout Slide

Enables safe management of multiple AC sources which use double or triple pole circuit breakers



4130

- Allows only 1 of a pair of double pole or triple pole AC toggle circuit breakers to be activated at a time
- Ensures AC power from 2 sources will not be mixed
- Fits all double or triple pole C-Series Toggle Circuit Breakers (p. 84)
- Uses circuit breaker mounting screw holes
- Includes mounting screws

Part #	4130	4131
Poles	2	3
AC Sources	2	2
Mounting	#6 Pan Head Screw	#6 Pan Head Screw

### A-Series Circuit Breaker Lockout Slide

Enables safe management of multiple AC sources which use double pole circuit breakers



4125

- Allows 1 double pole AC toggle circuit breaker to be activated
- Ensures AC power from 2 or more sources will not be mixed
- Fits all double pole A-Series Toggle Circuit Breakers (p. 82)
- Uses circuit breaker mounting screw holes
- Includes mounting screws

Part #	4125	4126
Poles	2	2
AC Sources	2	3
Mounting	#6 Flat Head Screw	#6 Flat Head Screw

### Toggle Guard

Protects toggle circuit breakers from accidental switching

- Fits A-Series single pole toggle circuit breakers (p. 82)
- Fits all panel switches (p. 96)
- Uses circuit breaker mounting screw holes
- Includes mounting screws

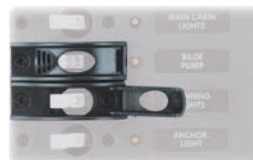

2 shown

Part #	4100
Mounting	#6 Flat Head Screw

## Small Format Labels

### Reinforced, waterproof labels

- Used on most Blue Sea Systems Contura Switch Water Resistant Panels (p. 114) and ST-Blade Fuse Blocks (p. 62-67)
- For a list of labels included see (p. 155)

Part #	Color	Quantity
8214	Black	60 Labels
8217	Gray	60 Labels

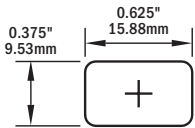

## Square Format Labels

### Reinforced, waterproof labels

- Used on 360 Panels (p. 116, 118-136), Battery Management Panels (p. 38), ST CLB Circuit Breaker Blocks (p. 74), Surface Mount System (p. 88), and WeatherDeck® Panels (p. 115)
- For a list of labels included see (p. 155)
- Available for purchase in sets or individually (p. 156)

Part #	Color	Description	Quantity
4215	Black	DC Labels	30 Labels
4218	Black	DC Labels	30 Labels
4216	Black	DC Labels	60 Labels
4217	Black	DC Labels	120 Labels

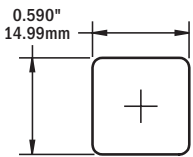

4215

## Large Format Labels

### Reinforced, waterproof labels

- Used on Contura Water-Resistant Fuse Panels 8053 & 8054 (p. 114)
- ST Glass Fuse Blocks (p. 61) and Traditional Metal Panels (p. 117-131)
- Available for purchase in sets or individually (p. 156-157)
- For a list of labels included see (p. 155)

Part #	Color	Description	Quantity
8031	Black	AC Panel Basic	30 Labels
8067	Black	AC Panel Extended	120 Labels
8030	Black	DC Panel Basic	30 Labels
8039	Black	DC Panel Extended	120 Labels

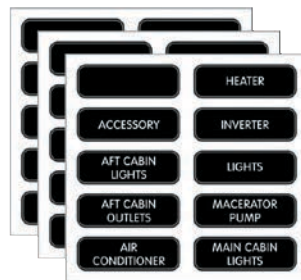
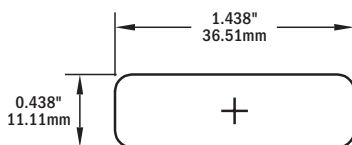

8031

## Round Icon Labels

### Reinforced, waterproof labels

- Used on 15A Backlit Push Button Switches (p. 95)
- Also available in a kit Part # 4230 (p. 95)
- To order individual labels, please indicate the Part # 6526 and the label number. Example below.

Individual Example:  
Round Icon Individual  
6526-1001



Label #	Description	Label	Label #	Description	Label
1001	ACCESSORY	ACC	1027	LIGHT 1	
1002	ACCESSORY 1	ACC 1	1028	LIGHT ANCHOR	
1003	ACCESSORY 2	ACC 2	1029	LIGHT COURTESY	
1004	ACCESSORY 3	ACC 3	1030	LIGHT COURTESY 1	
1005	AERATOR		1031	LIGHT COURTESY 2	
1006	ALARM		1032	LIGHT FLOOD BOW	
1007	ANCHOR		1033	LIGHT FLOOD COCKPIT	
1008	AUTO PILOT	AUTO PILOT	1034	LIGHT RUNNING	
1009	BATTERY SWITCH		1035	LIGHT SPREADER	
1010	BILGE BLOWER		1036	LIGHT SPREADER 2	
1011	BILGE PUMP		1037	LIGHT UNDERWATER BOW	
1012	BILGE PUMP 1		1038	LIGHT UNDERWATER STERN	
1013	BILGE PUMP 2		1039	LIVEWELL	
1014	BILGE PUMP 3		1040	LIVEWELL 1	
1015	BLANK		1041	RADAR	
1016	DC OUTLET	DC OUTLET	1042	SASQUATCH	
1017	DEPTH SOUNDER		1043	STEREO	
1018	ENGINE OFF		1044	THRUSTER	
1019	ENGINE START		1045	TRIM TAB	
1020	FAN		1046	VHF	
1021	FRESH WATER		1047	WASH DOWN	
1022	GPS		1048	WINDSHIELD WASHER	
1023	GYRO		1049	WINDSHIELD WIPER CENTER	
1024	HORN		1050	WINDSHIELD WIPER LEFT	
1025	HOSE DOWN		1051	WINDSHIELD WIPER RIGHT	
1026	LIGHT				

### Related Products



4121, 8065, 8069, 8383, 8384  
Label Backlight Systems  
See bluesea.com



Push Button Switches  
page 95



Push Button Switch Label Kit  
page 95

## Labels Included in Sets

### 4215

ACCESSORY
AERATOR
ANCHOR LIGHT
AUTOPILOT
BAIT PUMP
BILGE PUMP
BLOWER
CABIN LIGHTS
DEPTH SOUNDER
ELECTRONICS
GPS
HORN
INSTRUMENTS
KNOTMETER
NAV LIGHTS
RADAR
REFRIGERATOR
RUNNING LIGHTS
SEARCH LIGHT
SPARE
SPREADER LIGHTS
STEAMING LIGHT
STEREO
TRIM TABS
VHF
WASH DOWN
WATER PRESSURE
WATER PUMP
WINDLASS
WIPERS

### 4206 and 8031

(BLANK)
ACCESSORY
AFT CABIN LIGHTS
AFT CABIN OUTLETS
AIR CONDITIONER
AIR CONDITIONER 2
APPLIANCES
BATTERY CHARGER
CABIN OUTLETS
COMPUTER
ENTERTAINMENT CENTER
FWD CABIN LIGHTS
FWD CABIN OUTLETS
GALLEY
GALLEY OUTLETS
HEATER
INVERTER
LIGHTS
MACERATOR PUMP
MAIN CABIN LIGHTS
MAIN CABIN OUTLETS
MICROWAVE
OUTLETS
REFRIGERATOR
SPARE
STOVE
TV/STEREO
VCR
WASHER/DRYER
WATER HEATER

### 4217

(BLANK)
12 VOLT DC
12 VOLT DC OUTLETS
24 VOLT DC
AIR HORN
ANCHOR LIGHT MAIN
ANCHOR LIGHT MIZZEN
ANCHOR WASH DOWN
APPLIANCES
ARCH LIGHTS
AUTO/MAN
BAITWELL
BATTERY
BATTERY PARALLEL
BILGE ALARM
BILGE PUMP 2
BILGE PUMP ON-OFF-AUTO
BOW LIGHT
BOW THRUSTER
BRIDGE INSTRUMENTS
BRIDGE LIGHTS
CABIN
CB RADIO
CD PLAYER
CHART LIGHT
CHART PLOTTER
COCKPIT LIGHTS
COMPASS LIGHT
COURTESY LIGHTS
DAVIT

DC OUTLETS
DC SUB PANEL
DECK LIGHTS
DEFROSTER
DEPTH/SPEED
DIMMER
DISCHARGE PUMP
DOCKING LIGHT PORT
DOCKING LIGHT STBD
DOCKING LIGHTS
DOWN RIGGER
ELECTRIC HATCH
ENGINE HATCH
ENGINE INSTRUMENTS
ENGINE ROOM BLOWER
ENGINE ROOM LIGHTS
ENGINE SHUTDOWN
ENTRY STEP
FAN
FAN 2
FIRE ALARM
FIRE EXT
FISH FINDER
FISHING LIGHT
FISHWELL PUMP
FLOOD LIGHTS
FLYBRIDGE
FLYBRIDGE ELECTRONICS
FLYBRIDGE LIGHTS
FOG LIGHTS

FOREDECK LIGHT
FRESH WATER PUMP
FRESH WATER WASH DOWN
FUEL PUMP
FUEL TRANSFER
FURLER JIB
FURLER MAINSAIL
GALLEY
GAS ALARM
GPS/PLOTTER
HAILER
HAM RADIO
HEAD
HEATER
IGNITION
INSTRUMENT LIGHTS
INTERCOM HAILER
LAZARETTE LIGHTS
LIGHTER
LIGHTS
LIVWELL
LOCKER LIGHTS
LPG CONTROL
MAIN
MAST LIGHTS
MASTHEAD LIGHT
MIZZEN FLOOD
NAVIGATION ELECTRONICS
NAVIGATION INSTRUMENTS
NAV LIGHT ANCHOR OFF NAV

ON-OFF
OUTLETS
PUMP
PUMPOUT
RADIO
ROD LOCKER
RUDDER ANGLE INDICATOR
SAILING CONTROLS
SAILING INSTRUMENTS
SALT WATER PUMP
SEAWATER WASH DOWN
SHOWER SUMP PUMP
SOLAR PANEL
SSB
START-STOP
STERN LIGHT
STROBE LIGHT
SUMP PUMP
TRANSFER
TRICOLOR LIGHT
TROLLING MOTOR
WASHDOWN PUMP
WASHDOWN
WINCHES
WIND GENERATOR
WIND INSTRUMENTS
WINDSHIELD WASHER
WIPER CENTER
WIPER PORT
WIPER STBD

### 8214 and 8217

(BLANK)
12 VOLT DC
24 VOLT DC
ACCESSORY
AERATOR
ANCHOR LIGHT
AUTO PILOT
BAIT PUMP
BAITWELL
BATTERY
BATTERY CHARGER
BILGE
BILGE PUMP
BLOWER
BOW LIGHT
CABIN
CABIN LIGHTS
CB RADIO
CELLULAR PHONE
CHARGER INVERTER
CHART PLOTTER
DECK LIGHTS
DEPTH SOUNDER
DOWN RIGGER
ELECTRONICS
FAN
FISH FINDER
FISHING LIGHT
FLOOD LIGHTS
FUEL PUMP
GAS ALARM
GPS
HORN
IGNITION
INSTR. LIGHTS
INVERTER
KNOT METER
LIGHTS
LIVWELL
NAV LIGHTS
OUTLETS
RADIO
RADAR
REFRIGERATION
RUNNING LIGHTS
SEARCH LIGHT
SPREADER LIGHTS
STEAMING LIGHT
STEREO
STROBE LIGHT
TRICOLOR LIGHT
TRIM TABS
USB CHARGER
VHF
WASH DOWN
WATER PRESSURE
WATER PUMP
WINCHES
WINDLASS
WIPERS

### 4218

12 VOLT DC
24 VOLT DC
ALARM
BILGE PUMP
BILGE PUMP 2
BILGE PUMP 3
BILGE PUMP 4
BOW THRUSTER
CLOCK
DC MAIN
DC SUB PANEL
ELECTRONICS
ENGINE
ENGINES
ENG 1/ENG 2
GENERATOR
HOUSE
HOUSE/ENG
HOUSE/GEN
INVERTER
LIGHTS
MEMORY
PORT/STBD ENG
RADAR
RADIO
SOLAR PANEL
VHF
WINCH
WINDLASS
Blank (Write On)

### 4216

(BLANK)
12 VOLT DC
12 VOLT DC OUTLETS
ANCHOR WASH DOWN
BAITWELL
BATTERY
BATTERY PARALLEL
BILGE
BILGE PUMP 2
BILGE PUMP ON-OFF-AUTO
BOW LIGHT
CABIN
CB RADIO
CELLULAR PHONE
CHART LIGHT
CHART PLOTTER
COCKPIT LIGHTS
COMPASS LIGHT
COURTESY LIGHTS
DAVIT
DC OUTLETS
DC SUB PANEL
DECK LIGHTS
DOCKING LIGHTS
DOWN RIGGER
ELECTRIC HATCH
ENGINE ROOM BLOWER
ENGINE ROOM LIGHTS
FAN
FISH FINDER
FISHING LIGHT
FISHWELL PUMP
FLOOD LIGHTS
FRESH WATER PUMP
FUEL PUMP
GALLEY OUTLETS
GAS ALARM
GPS/PLOTTER
HEAD
IGNITION
INSTRUMENT LIGHTS
LIGHTS
LIVWELL
MACERATOR PUMP
NAV LIGHT ANCHOR OFF-NAV
OUTLETS
PUMPOUT
RADIO
SEAWATER WASH DOWN
SHOWER SUMP PUMP
SSB
STERN LIGHT
STROBE LIGHT
TRICOLOR LIGHT
TROLLING MOTOR
WASHDOWN
WATER MAKER
WINCHES
WIPER PORT
WIPER STBD

### 4207 and 8039

(BLANK)
12 VOLT DC
12 VOLT DC OUTLETS
AFT CABIN
AFT HEAD
ALARM SYSTEM
ANCHOR WASH DOWN
BAIT PUMP
BILGE ALARM
BILGE PUMP 2
BRIDGE INSTRUMENTS
CABIN 2 LIGHTS
CABIN 3 LIGHTS
CABIN 4 LIGHTS
CABIN FANS
CABIN LIGHTS
CB RADIO
CELLULAR PHONE
CHART LIGHT
CHART PLOTTER
COCKPIT LIGHTS
COLOR SOUNDER
COMM ELECTRONICS
DC LIGHTS
DC MAIN
DC OUTLETS
DC REFRIGERATOR
DC SUB PANEL
DECK LIGHTS
DECK LIGHTS AFT

DECK LIGHTS FWD
DEPTH RECORDER
DEPTH/SPEED
DESALINATOR
DIMMER
DINING AREA LIGHTS
DOCKING LIGHTS
EMERGENCY LIGHTS
ENGINE ROOM BILGE ALARM
ENGINE ROOM LIGHTS
ENGINE ROOM PANEL MAIN
ENGINE ALARM
EXTERIOR LIGHTS
FAN 2
FIRE ALARM
FISHING LIGHT
FLOOD LIGHTS
FLYBRIDGE ELECTRONICS
FLYBRIDGE LIGHTS
FRESH WATER PUMP
FRESH WATER WASH DOWN
GALLEY LIGHTS
GPS/PLOTTER
HAILER
HAM RADIO
HEAD
HEAD LIGHTS
HEAD LIGHTS 2
HEATER 2
HELM ELECTRONICS

HELM GAUGES
HELM INSTRUMENTS
HIGH WATER ALARM
HOLDING TANK
HOLDING TANK ALARM
HOLDING TANK PUMP
INSTRUMENT LIGHTS
INSTRUMENTS
INTERCOM
INTERIOR LIGHTS
LIGHTS 2
LIVWELL
LOG
LORAN
MAIN CABIN
MAP LIGHT
MAST LIGHTS
NAV STATION ELECTRONICS
NAV STATION GAUGES
NAV STATION INSTRUMENTS
NAV STATION LIGHTS
NAVIGATION ELECTRONICS
NAVIGATION INSTRUMENTS
NAVIGATION LIGHTS
RACK LIGHTS
RADIO
SALOON
SALOON LIGHTS
SAT/COM
SAT/NAV

SATELLITE DISH
SEARCHLIGHT
SEAWATER TEMP
SEAWATER WASH DOWN
SECURITY SYSTEM
SHOWER SUMP PUMP
SONAR
SPEED/LOG
SSB
SUB PANEL
SUMP PUMP
TELEPHONE SYSTEM
TRACK LIGHTS
TRANSFER PUMP
TRIM TABS
TV
TV/VCR
UTILITY
VIDEO PLOTTER
WATER ALARM
WATER MAKER
WATER PUMP
WEATHER FAX
WEATHER INSTRUMENT
WINCHES
WIND INSTRUMENTS
WINDEX LIGHT
WIPER PORT
WIPER STBD
WIPERS

### 4205 and 8030

ACCESSORY
ANCHOR LIGHT
AUTOPILOT
BILGE PUMP
BLOWER
COMPASS LIGHT
DEPTH SOUNDER
ELECTRONICS
ENGINE INSTRUMENTS
FAN
FOREDECK LIGHT
FWD CABIN LIGHTS
GPS
HORN
KNOTMETER
LIGHTS
MACERATOR PUMP
MAIN CABIN LIGHTS
RADAR
REFRIGERATOR
RUNNING LIGHTS
SAILING INSTRUMENTS
SPARE
SPREADER LIGHTS
STEAMING LIGHT
STEREO
STROBE LIGHT
TRICOLOR LIGHT
VHF
WATER PRESSURE

### 4208 and 8067

(BLANK)
120 VOLT AC OUTLETS
120 VOLTS AC / 60 HZ
AC COMPRESSOR
AC FAN
AC MAIN
AC PANEL
AC POWER
AC REFRIGERATOR
AC SUB PANEL
AFT CABIN
AFT HEAD
AIR CONDITIONER 3
AIR CONDITIONER 4
ALARM SYSTEM
AMPLIFIER
AUDIO/VIDEO SYSTEM
BATTERY CHARGER 2
BRIDGE LIGHTS
BRIDGE OUTLETS
CABIN
CABIN 2
CABIN 2 LIGHTS
CABIN 2 OUTLETS
CABIN 3
CABIN 3 LIGHTS
CABIN 3 OUTLETS
CABIN 4
CABIN 4 LIGHTS
CABIN 4 OUTLETS

CABIN HEATER
CABIN LIGHTS
CHARGER/INVERTER
COCKPIT LIGHTS
COCKPIT REFRIGERATOR
COMPARTMENT LIGHT
COOKTOP
DECK LIGHTS
DIMMER
DINING AREA LIGHTS
DINING AREA OUTLETS
DISHWASHER
DISPOSAL
DRYER
EMERGENCY LIGHTS
ENGINE ROOM LIGHTS
ENGINE ROOM OUTLETS
EXHAUST FAN
EXTERIOR LIGHTS
FAN
FAN 2
FAN 3
FAN 4
FLOOD LIGHTS
FREEZER
FURNACE
GALLEY APPLIANCES
GALLEY LIGHTS
GARBAGE DISPOSAL
GENERATOR 1

GFI OUTLET
HALLWAY LIGHTS
HEAD 2 OUTLETS
HEAD 3 OUTLETS
HEAD 4 OUTLETS
HEAD LIGHTS
HEAD LIGHTS 2
HEAD LIGHTS 3
HEAD LIGHTS 4
HEAD OUTLETS
HEADLIGHTS
HEATER 2
HEATER 3
HEATER 4
HOOD FAN
ICEMAKER
INTERIOR LIGHTS
INVERTER OUTLET
ISOLATION TRANSFORMER
LAZARETTE LIGHTS
LECTRASAN
LIGHTS 2
LIGHTS 3
LIGHTS 4
LIGHTS AFT
LIGHTS FWD
MAIN
MAIN BREAKER
MAIN CABIN
NAV STATION LIGHTS

OUTLETS 2
OUTLETS 3
OUTLETS 4
OUTLETS DECK
OUTLETS EXTERIOR
OUTLETS INTERIOR
RACK OUTLETS
RANGE
REFRIGERATOR/FREEZER
REVERSE POLARITY
SALOON
SALOON HEATER
SALOON LIGHTS
SALOON OUTLETS
SATELLITE DISH
SHIP
SHORE
SHORE POWER
STEREO
STOVE/MICROWAVE
SUB PANEL
TELEPHONE SYSTEM
TRACK LIGHTS
TRASH COMPACTOR
TV
UPS SYSTEM
VACUUM
VIDEO SYSTEM
WASHER
WATER MAKER

### Label set included with Source Selection Panels

(not sold separately)
Blank WRITE-ON
INVERTER
SHORE
SHORE 1
SHORE 2
AC BUS 1
AC BUS 2
GENERATOR
GENERATOR 1
GENERATOR 2



## Individual Square and Large Format Panel Labels

To order individual labels, please indicate the Part # (6520 or 8063) and the Label Part #.

Label Part #	Label Text	Label Part #	Label Text	Label Part #	Label Text	Label Part #	Label Text
0001	LABEL #1	0485	BEDROOM SLIDEOUT	0125	DECK LIGHTS AFT	0189	FISHING LIGHT
0002	LABEL #2	0055	BILGE	0126	DECK LIGHTS FWD	0487	FISHWELL PUMP
0003	(BLANK)	0056	BILGE ALARM	0127	DECK LIGHTS PORT	0488	FISHWELL PUMP 2
0005	12 VOLT DC	0057	BILGE ALARM 2	0128	DECK LIGHTS STBD	0576	FLOAT SWITCH
0004	12 VOLT DC OUTLETS	0058	BILGE ALARM 3	0129	DEFROSTER	0190	FLOOD LIGHTS
0499	12 VOLT OUTLETS INSIDE	0059	BILGE ALARM 4	0130	DEPTH RECORDER	0191	FLOSCAN
0500	12 VOLT OUTLETS OUTSIDE	0060	BILGE LIGHTS	0131	DEPTH SOUNDER	0192	FLYBRIDGE
0502	120 VOLT / 60 HZ SHORE POWER	0061	BILGE PUMP	0132	DEPTH/SPEED	0193	FLYBRIDGE ELECTRONICS
0007	120 VOLT AC / 60 HZ	0062	BILGE PUMP 2	0133	DESALINATOR	0194	FLYBRIDGE LIGHTS
0006	120 VOLT AC OUTLETS	0063	BILGE PUMP 3	0134	DIMMER	0195	FLYBRIDGE OUTLETS
0516	120/240V 60 HZ	0064	BILGE PUMP 4	0135	DINING AREA LIGHTS	0196	FOG LIGHTS
0517	120/240V 60 HZ SHORE POWER	0453	BILGE PUMP ON-OFF-AUTO	0136	DINING AREA OUTLETS	0197	FOREDECK LIGHT
0526	230 VOLTS AC 50 HZ	0559	BLANK WHITE WRITABLE	0137	DISCHARGE PUMP	0539	FORWARD BILGE
0010	24 VOLT DC	0065	BLOWER	0567	DISCHARGE PUMP 2	0198	FREEZER
0009	24 VOLT DC OUTLET	0066	BOAT DAVIT	0568	DISCHARGE PUMP 3	0199	FRESH WATER
0008	240 VOLTS AC	0067	BOOM LIGHT	0138	DISHWASHER	0200	FRESH WATER PUMP
0460	240 VOLTS AC / 60 HZ	0068	BOW LIGHT	0139	DISPOSAL	0201	FRESH WATER PUMP 2
0515	250 VOLT 50HZ SHORE POWER	0069	BOW THRUSTER	0140	DIVE COMPRESSOR	0202	FRESH WATER PUMP 3
0468	250 VOLTS AC / 50 HZ	0070	BRIDGE	0141	DOCKING LIGHT PORT	0203	FRESH WATER PUMP 4
0462	AC BUS 1	0071	BRIDGE INSTRUMENTS	0142	DOCKING LIGHT STBD	0204	FRESH WATER WASH DOWN
0011	AC COMPRESSOR	0072	BRIDGE LIGHTS	0143	DOCKING LIGHTS	0482	FRONT SLIDEOUT
0012	AC FAN	0073	BRIDGE OUTLETS	0144	DOWN RIGGER	0561	FUEL GAUGE
0013	AC MAIN	0074	CABIN	0145	DRYER	0205	FUEL PRIMER PUMP
0014	AC PANEL	0075	CABIN 2	0146	DUMP VALVES	0206	FUEL PUMP
0015	AC POWER	0501	CABIN 2 FAN	0566	ECU	0207	FUEL PUMP 2
0016	AC REFRIGERATOR	0076	CABIN 2 LIGHTS	0580	ELCI	0208	FUEL PUMP 3
0017	AC SUB PANEL	0077	CABIN 2 OUTLETS	0147	ELECTRIC HATCH	0209	FUEL PUMP 4
0532	ACCENT LIGHT	0078	CABIN 3	0469	ELECTRONIC CONTROL UNIT	0210	FUEL TANK HEATER
0018	ACCESSORY	0079	CABIN 3 LIGHTS	0148	ELECTRONICS	0211	FUEL TRANSFER
0019	ADF	0080	CABIN 3 OUTLETS	0149	EMERGENCY BACKUP SYS	0507	FUME DETECTOR
0020	AERATOR	0081	CABIN 4	0150	EMERGENCY LIGHTS	0212	FURLER JIB
0021	AFT CABIN	0082	CABIN 4 LIGHTS	0151	EMERGENCY PUMPS	0213	FURLER MAINSAIL
0022	AFT CABIN LIGHTS	0083	CABIN 4 OUTLETS	0545	ENGINE	0214	FURLER SPINNAKER
0023	AFT CABIN OUTLETS	0084	CABIN FAN	0581	ENGINE 1	0215	FURNACE
0536	AFT CABIN SUMP	0085	CABIN HEATER	0582	ENGINE 2	0216	FWD CABIN
0530	AFT DISCHARGE PUMP	0086	CABIN LIGHTS	0547	ENG 1/ENG 2	0217	FWD CABIN LIGHTS
0024	AFT HEAD	0087	CABIN OUTLETS	0158	ENGINE ALARM	0218	FWD CABIN OUTLETS
0025	AIR COMPRESSOR	0088	CABLEMASTER	0159	ENGINE BLOCK HEATER	0529	FWD DISCHARGE PUMP
0026	AIR CONDITIONER	0089	CASSETTE PLAYER	0160	ENGINE CONTROL PORT	0528	FWD HEAD
0027	AIR CONDITIONER 2	0090	CB RADIO	0161	ENGINE CONTROL STBD	0219	GALLEY
0028	AIR CONDITIONER 3	0091	CCTV	0162	ENGINE CONTROLS	0220	GALLEY APPLIANCES
0029	AIR CONDITIONER 4	0092	CD PLAYER	0163	ENGINE DRIVEN REFRIG	0221	GALLEY DRAIN
0030	AIR CONDITIONER PUMP	0093	CELLULAR PHONE	0164	ENGINE EXHAUST FAN	0222	GALLEY FAN
0031	AIR HORN	0537	CENTER LIVEWELL	0165	ENGINE HATCH	0223	GALLEY LIGHTS
0573	AIS	0094	CHARGER/INVERTER	0166	ENGINE HEATER PORT	0224	GALLEY OUTLETS
0544	ALARM	0095	CHART LIGHT	0167	ENGINE HEATER STBD	0490	GALVANIC ISOLATOR
0032	ALARM SYSTEM	0096	CHART PLOTTER	0168	ENGINE INSTRUMENTS	0225	GARBAGE DISPOSAL
0461	ALTERNATOR	0097	CHOKE	0169	ENGINE OIL PAN PUMP	0226	GAS ALARM
0033	ALTERNATOR DISCONNECT	0098	CIRCULATOR PUMP	0152	ENGINE ROOM BILGE ALARM	0227	GENERAL PURPOSE
0034	AMPLIFIER	0508	CLOCK	0153	ENGINE ROOM BLOWER	0523	GENERATOR
0035	ANCHOR LIGHT	0099	CLOSET LIGHT	0154	ENGINE ROOM HEATER	0228	GENERATOR 1
0036	ANCHOR LIGHT MAIN	0575	CO DETECTOR	0155	ENGINE ROOM LIGHTS	0229	GENERATOR 2
0037	ANCHOR LIGHT MIZZEN	0100	COCKPIT LIGHTS	0156	ENGINE ROOM OUTLETS	0454	GENERATOR OFF ON START
0038	ANCHOR WASH DOWN	0101	COCKPIT REFRIG	0157	ENGINE ROOM PANEL MAIN	0230	GENERATOR ROOM BLOWER
0039	APPLIANCES	0102	COLOR SOUNDER	0170	ENGINE SHUTDOWN	0466	GENERATOR RUNNING
0040	ARCH LIGHTS	0103	COMM ELECTRONICS	0171	ENGINE TEMP	0455	GENERATOR STOP
0041	AUDIO/VIDEO SYSTEM	0104	COMPARTMENT HEATER	0546	ENGINES	0578	GFCI
0525	AUTO FILL	0105	COMPARTMENT LIGHT	0172	ENTERTAINMENT CENTER	0231	GFI OUTLET
0042	AUTO/MANUAL	0106	COMPASS LIGHT	0173	ENTRANCE DOOR	0232	GPS
0555	AUTO/MAN	0107	COMPUTER	0174	ENTRY STEP	0233	GPS/LORAN
0524	AUTOMATIC CHARGING RELAY	0514	COMPUTER DISPLAY	0175	EXHAUST FAN	0234	GPS/PLOTTER
0043	AUTOPILOT	0108	CONDENSER PUMP	0176	EXHAUST TEMP	0510	GUN LOCKS
0044	BAIT PUMP	0109	CONSOLE LIGHT	0177	EXTERIOR	0235	GYRO COMPASS
0045	BAITWELL	0110	CONVERTER	0178	EXTERIOR LIGHTS	0236	HAILER
0046	BALLAST CONTROLS	0111	COOKING GRILL	0179	FAN	0237	HALLWAY LIGHTS
0047	BALLAST PUMP	0112	COOKTOP	0180	FAN 2	0238	HALON FIRE SYSTEM
0048	BAR	0113	COOLING PUMP	0181	FAN 3	0239	HAM RADIO
0481	BATHROOM	0114	COURTESY LIGHTS	0182	FAN 4	0240	HEAD
0049	BATTERY	0115	CREW LIGHTS	0183	FAX	0241	HEAD 2
0473	BATTERY 1	0116	CREW QUARTERS	0184	FILLING PUMP	0242	HEAD 2 FAN
0474	BATTERY 2	0117	DAVIT	0185	FIRE ALARM	0243	HEAD 2 OUTLETS
0050	BATTERY CHARGER	0118	DC LIGHTS	0186	FIRE EXT	0244	HEAD 3
0051	BATTERY CHARGER 2	0119	DC MAIN	0187	FIRE HORN	0245	HEAD 3 FAN
0052	BATTERY COMPARTMENT	0120	DC OUTLETS	0459	FISH FINDER	0246	HEAD 3 OUTLETS
0053	BATTERY PARALLEL	0121	DC REFRIGERATOR	0538	FISHBOX DRAIN	0247	HEAD 4
0560	BATTERY SWITCH	0122	DC SUB PANEL	0188	FISHBOX ICEMAKER	0248	HEAD 4 FAN
0054	BEACON	0123	DECK	0520	FISHBOX PUMP	0249	HEAD 4 OUTLETS
0480	BEDROOM	0124	DECK LIGHTS	0521	FISHBOX REFRIGERATOR	0250	HEAD FAN

Example:

Square Format  
6520-0044



Large Format  
8063-0356

REFRIGERATOR

Label Part #	Label Text
0251	HEAD LIGHTS
0252	HEAD LIGHTS 2
0253	HEAD LIGHTS 3
0254	HEAD LIGHTS 4
0255	HEAD OUTLETS
0256	HEADLIGHTS
0257	HEATER
0519	HEATER & AIR CONDITIONER
0258	HEATER 2
0259	HEATER 3
0260	HEATER 4
0261	HELM ELECTRONICS
0262	HELM GAUGES
0263	HELM INSTRUMENTS
0264	HIGH WATER ALARM
0265	HOLDING TANK
0266	HOLDING TANK ALARM
0267	HOLDING TANK PUMP
0268	HOOD FAN
0269	HOOD LIGHT
0270	HORN
0475	HOT TUB
0271	HOT WATER PUMP
0548	HOUSE
0549	HOUSE/ENG
0550	HOUSE/GEN
0272	HYDRAULIC ALARM
0273	HYDRAULIC SYSTEM
0274	HYDRAULIC TANK ALARM
0570	HYDRAULIC VALVE
0275	ICE MAKER
0276	IGNITION
0277	IGNITION PORT
0278	IGNITION STBD
0279	INSTRUMENT LIGHTS
0280	INSTRUMENTS
0281	INTERCOM
0282	INTERCOM HAILER
0283	INTERCOM/TELEPHONE
0284	INTERIOR LIGHTS
0556	INTERNET
0285	INVERTER
0467	INVERTER 2
0476	INVERTER AC BUS
0471	INVERTER AC SUPPLY
0470	INVERTER DC SUPPLY
0286	INVERTER OUTLET
0287	ISOLATION TRANSFORMER
0479	KITCHEN
0484	KITCHEN SLIDEOUT
0288	KNOTMETER
0289	LAZARETTE LIGHTS
0290	LECTRASAN
0291	LIGHTER
0292	LIGHTS
0293	LIGHTS 2
0294	LIGHTS 3
0295	LIGHTS 4
0296	LIGHTS AFT
0494	LIGHTS AFT CABIN
0297	LIGHTS FWD
0493	LIGHTS MASTER CABIN
0495	LIGHTS PANTRY
0492	LIGHTS PILOTHOUSE
0298	LIGHTS PORT
0491	LIGHTS SETTEE
0299	LIGHTS STBD
0300	LIVWELL
0301	LIVWELL INPUT
0302	LIVWELL OUTPUT
0303	LOCKER LIGHTS
0304	LOG
0305	LORAN
0306	LPG CONTROL
0307	LUBE OIL PUMP
0308	MACERATOR PUMP
0309	MAIN
0310	MAIN BREAKER

Label Part #	Label Text
0311	MAIN CABIN
0312	MAIN CABIN LIGHTS
0313	MAIN CABIN OUTLETS
0314	MAIN SAIL FURLING
0315	MAP LIGHT
0572	MARINE SANITATION DEVICE
0316	MAST LIGHTS
0317	MASTHEAD LIGHT
0551	MEMORY
0574	MERCATHODE
0318	MICROWAVE
0319	MINI DISC PLAYER
0320	MIZZEN FLOOD
0456	NAV LIGHT ANCHOR OFF NAV
0321	NAV STATION ELECTRONICS
0322	NAV STATION GAUGES
0323	NAV STATION INSTRUMENTS
0324	NAV STATION LIGHTS
0325	NAVIGATION ELECTRONICS
0326	NAVIGATION INSTRUMENTS
0327	NAVIGATION LIGHTS
0565	NETWORK
0328	NIGHT LIGHTS
0329	OFF
0331	OIL CHANGE PUMP
0563	OIL GAUGE
0332	ON
0330	ON-OFF
0333	OUTLETS
0334	OUTLETS 2
0335	OUTLETS 3
0336	OUTLETS 4
0505	OUTLETS AFT
0337	OUTLETS DECK
0506	OUTLETS ENGINE ROOM
0338	OUTLETS EXTERIOR
0503	OUTLETS FORWARD
0339	OUTLETS INTERIOR
0504	OUTLETS PILOT HOUSE
0458	PANEL LIGHTS
0496	PILOT HOUSE FAN
0340	PORT
0540	PORT FISHBOX
0534	PORT LIVWELL
0341	PORT THRUSTER
0552	PORT/STBD ENG
0342	POWER
0343	POWER WASHER
0457	PRE-HEAT
0344	PRIMARY WINCHES
0345	PRINTER
0346	PUMP
0497	PUMP BLACK WATER
0498	PUMP GRAY WATER
0554	PUMPOUT
0347	RACK LIGHTS
0348	RACK OUTLETS
0349	RADAR
0350	RADAR ARCH LIGHTS
0351	RADIO
0352	RANGE
0579	RCBO
0353	RDF
0483	REAR SLIDEOUT
0354	RECEIVER
0355	RECEPTACLE
0356	REFRIGERATOR
0357	REFRIGERATOR PUMP
0358	REFRIGERATOR/FREEZER
0359	REGULATOR
0360	REVERSE POLARITY
0361	ROD LOCKER
0489	RUDDER ANGLE INDICATOR
0362	RUNNING LIGHTS
0363	SAILING CONTROLS
0364	SAILING INSTRUMENTS
0365	SALOON
0366	SALOON HEATER

Label Part #	Label Text
0367	SALOON LIGHTS
0368	SALOON OUTLETS
0369	SALT WATER PUMP
0370	SAT/COM
0371	SAT/NAV
0372	SATELLITE DISH
0373	SCRUBBER
0374	SEARCHLIGHT
0375	SEARCHLIGHT HAND HELD
0376	SEARCHLIGHT REMOTE
0377	SEAWATER TEMP
0378	SEAWATER WASH DOWN
0379	SECURITY SYSTEM
0380	SHIP
0381	SHORE
0463	SHORE 1
0464	SHORE 2
0382	SHORE CORD REEL
0383	SHORE POWER
0384	SHORE POWER CORD
0385	SHOWER SUMP PUMP
0386	SINK DRAIN
0486	SLIDEOUT
0387	SOLAR PANEL
0388	SONAR
0542	SONAR/ACC
0389	SPARE
0390	SPEED/LOG
0391	SPREADER LIGHTS
0392	SPREADER LT MIZZEN
0393	SSB
0394	STABILIZER
0558	STAIR LIGHT
0395	STARBOARD
0396	START
0398	START PORT
0399	START STBD
0397	START-STOP
0541	STBD FISHBOX
0533	STBD LIVWELL
0400	STBD THRUSTER
0401	STEAMING LIGHT
0569	STEERING VALVE
0402	STEP LIGHT
0403	STEREO
0577	STEREO MEMORY
0404	STERN LIGHT
0509	STERN THRUSTER
0405	STOP
0406	STOVE
0407	STOVE/MICROWAVE
0408	STROBE LIGHT
0409	SUB PANEL
0410	SUMP PUMP
0411	SUMP PUMP 2
0412	SYNCHRO
0564	TANK GAUGE
0413	TAPE DECK
0414	TELEPHONE SYSTEM
0415	TEST
0416	TOWING LIGHTS
0417	TRACK LIGHTS
0465	TRANSFER
0418	TRANSFER PUMP
0419	TRANSFORMER
0518	TRANSFORMER SECONDARY
0420	TRASH COMPACTOR
0478	TRAVEL LOCKS
0421	TRICOLOR LIGHT
0422	TRIM TABS
0527	TROLLING MOTOR
0423	TV
0424	TV ANTENNA
0425	TV/STEREO
0426	TV/VCR
0535	UNDERWATER LIGHT
0427	UPS SYSTEM
0428	UTILITY

Label Part #	Label Text
0429	VACUUM
0430	VACUUM PUMP
0431	VCR
0432	VHF
0511	VHF 1
0512	VHF 2
0433	VIDEO PLOTTER
0434	VIDEO SYSTEM
0543	WASHDOWN
0513	WASHDOWN PUMP
0435	WASHER
0436	WASHER/DRYER
0437	WATER ALARM
0562	WATER GAUGE
0438	WATER HEATER
0439	WATER LEVEL
0440	WATER MAKER
0441	WATER PRESSURE
0442	WATER PUMP
0443	WEATHER FAX
0444	WEATHER INSTRUMENT
0571	WIFI
0553	WINCH
0445	WINCHES
0477	WIND GENERATOR
0446	WIND INSTRUMENTS
0522	WIND SHIELD VENT
0447	WINDEX LIGHT
0448	WINDLASS
0449	WINDSHIELD WASHER
0472	WIPER CENTER
0450	WIPER PORT
0451	WIPER STBD
0452	WIPERS
0557	WIRELESS

## Emergency Vehicle Label Set

For emergency vehicles

- 180 Reinforced, waterproof labels
- Used on all ST-Blade Fuse Blocks

Part #	7870
Color	Black
Quantity	180 Labels

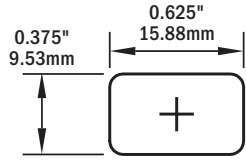

### Related Products



ST-Blade Fuse Blocks pages 62-67

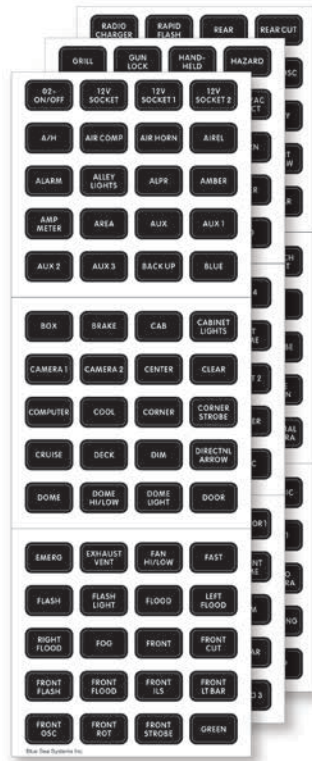

## Circuit Identification Label Kit

Used on Blue Sea Systems Battery Switches

- Reinforced, waterproof labels
- Used on Manual Battery Switches (p. 30-34)

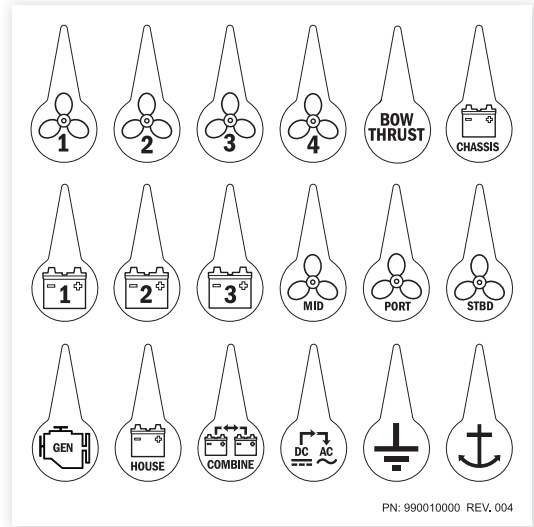

Part #	7902
Quantity	18 Labels

### Labels Included

ON/OFF	FLASH LIGHT	LIGHT 2	RIGHT DOME
12V SOCKET	FLOOD	LOAD SHED	RIGHT FLOOD
12V SOCKET 1	FOG	LOCK	RIGHT SCENE
12V SOCKET 2	FRONT	LOW POWER	RISER
A/H	FRONT CUT	LOWER	RMBLR
AIR COMP	FRONT FLASH	LVD	ROT
AIR HORN	FRONT FLOOD	MAN	SCENE
AIREL	FRONT ILS	MAP LIGHT	SCENE LIGHT
ALARM	FRONT LT BAR	MDC	SEARCH LIGHT
ALLEY LIGHTS	FRONT OSC	MESSAGE BOARD	SEC
ALPR	FRONT ROT	MODEM	SIDE
AMBER	FRONT STROBE	MONITOR	SLOW SPEED
AMP METER	GREEN	MONITOR 1	SM
AREA	GRILL	MONITOR 2	SPOT
AUX	GUN LOCK	OSC	START STOP
AUX 1	HAND-HELD	PA	STEP
AUX 2	HAZARD	PATIENT DOME	STROBE
AUX 3	HEADLT FLASH	PERIMETER	SUCTION ON/OFF
BACK UP	HEAT	PERIMETER 1	SURE EJECT
BLUE	HEAT/AC ON/OFF	PERIMETER 2	TAIL
BOX	HEAT/AC SELECT	PRIM	TAKE DOWN
BRAKE	HI-IDL	PRIORITY	TAP II
CAB	HI-LOW	PURSUIT	TCL
CABINET LIGHTS	HORN	Q SIR	TEMP METER
CAMERA 1	HORN 1	RADAR	THERMAL CAMERA
CAMERA 2	HORN SIREN	RADIO	TIMER
CENTER	IGN RELAY	RADIO 1	TONE
CLEAR	INFRARED	RADIO 2	TOW
COMPUTER	INTER	RADIO 3	TRAFFIC
COOL	JOG	RADIO CHARGER	TRUNK
CORNER	JOG LEFT	RAPID FLASH	UPPER
CORNER STROBE	JOG RIGHT	REAR	USB
CRUISE	LED	REAR CUT	USB 1
DECK	LED 1	REAR FLASH	USB 2
DIM	LED 2	REAR FLOOD	USB 3
DIRECTNL ARROW	LED 3	REAR FLOOD	VIDEO
DOME	LED 4	REAR ILS	VIDEO CAMERA
DOME HI/LOW	LEFT	REAR OSC	VOLT METER
DOME LIGHT	LEFT ALLEY	REAR SCENE	WAIL
DOOR	LEFT ARROW	REAR STROBE	WARN
EMERG	LEFT DOME	RED	WARNING
EXHAUST VENT	LEFT FLOOD	RELAY	WHT LT CUT
FAN HI/LOW	LEFT SCENE	RESET	WIG WAG
FAST	LIGHT	RIGHT	WORK
FLASH	LIGHT 1	RIGHT ALLEY	YELP



# Protect Your Boat With the Correct Size Wire and Fuse



Scan to download the app or go to [www.circuitwizard.blueseas.com](http://www.circuitwizard.blueseas.com)

## 1. Choose the Correct Wire

a) Locate the CURRENT FLOW IN AMPS of your circuit

b) Select the CIRCUIT TYPE

- Non-critical circuits with 10% allowable voltage drop include: general lighting, windlasses, bait pumps, general appliances
- Critical circuits with 3% allowable voltage drop include: panel main feeders, bilge blowers, electronics, navigation lights

c) Find the CIRCUIT LENGTH

The circuit length is the length of the negative wire added to the length of the positive wire.

Calculations are based on 105°C wire. For wire rated at 90°C or lower, or for wire that passes through an engine room, the first row of the chart does not apply.

d) Intersect the CURRENT FLOW IN AMPS with CIRCUIT LENGTH to identify the correct wire size

*Example: A windlass rated 80A is 25 ft. from the battery. The circuit length is the total length of the positive and negative wire added together, which in this example is 50 ft. The circuit type is 'non-critical', and the correct wire size is 4 AWG.*

Calculations are based on 105°C wire. For more detailed calculations, download the Circuit Wizard app or go to [circuitwizard.blueseas.com](http://circuitwizard.blueseas.com)

## WIRE SELECTION CHART

Standard and Metric Wire Comparison Table	CIRCUIT TYPE		CURRENT FLOW IN AMPS															
	10% VOLTAGE DROP Non Critical	3% VOLTAGE DROP Critical	5A	10A	15A	20A	25A	30A	40A	50A	60A	70A	80A	90A	100A	120A	150A	200A
	0 to 20 ft. (0 to 6.1 M)	0 to 6 ft. (0 to 1.8 M)																
30 ft. (9.1 M)	10 ft. (3.0 M)	16 AWG	16 AWG	14 AWG	14 AWG	12 AWG	12 AWG	10 AWG	10 AWG	8 AWG	6 AWG	6 AWG	6 AWG	4 AWG	4 AWG	2 AWG	1 AWG	2 1/0 AWG
50 ft. (15.2 M)	15 ft. (4.6 M)	14 AWG	12 AWG	10 AWG	10 AWG	8 AWG	8 AWG	6 AWG	6 AWG	4 AWG	4 AWG	4 AWG	2 AWG	2 AWG	2 AWG	1 AWG	0 AWG	2 1/0 AWG
65 ft. (19.8 M)	20 ft. (6.1 M)	12 AWG	10 AWG	8 AWG	8 AWG	6 AWG	6 AWG	4 AWG	4 AWG	2 AWG	2 AWG	2 AWG	1 AWG	1 AWG	0 AWG	0 AWG	2 1/0 AWG	3 1/0 AWG
80 ft. (24.4 M)	25 ft. (7.6 M)	10 AWG	8 AWG	6 AWG	6 AWG	4 AWG	4 AWG	2 AWG	2 AWG	1 AWG	1 AWG	1 AWG	0 AWG	0 AWG	2 1/0 AWG	2 1/0 AWG	3 1/0 AWG	4 1/0 AWG
100 ft. (30.5 M)	30 ft. (9.1 M)	8 AWG	6 AWG	4 AWG	4 AWG	2 AWG	2 AWG	1 AWG	1 AWG	0 AWG	0 AWG	2 1/0 AWG	2 1/0 AWG	2 1/0 AWG	3 1/0 AWG	3 1/0 AWG	4 1/0 AWG	4 1/0 AWG
130 ft. (39.6 M)	40 ft. (12.2 M)	6 AWG	4 AWG	2 AWG	2 AWG	1 AWG	1 AWG	0 AWG	0 AWG	2 1/0 AWG	2 1/0 AWG	3 1/0 AWG	3 1/0 AWG	3 1/0 AWG	4 1/0 AWG	4 1/0 AWG	4 1/0 AWG	4 1/0 AWG
165 ft. (50.3 M)	50 ft. (15.2 M)	4 AWG	2 AWG	1 AWG	1 AWG	0 AWG	0 AWG	2 1/0 AWG	2 1/0 AWG	3 1/0 AWG	3 1/0 AWG	4 1/0 AWG	4 1/0 AWG	4 1/0 AWG	4 1/0 AWG	4 1/0 AWG	4 1/0 AWG	4 1/0 AWG
200 ft. (61.0 M)	60 ft. (18.3 M)	2 AWG	1 AWG	0 AWG	0 AWG	2 1/0 AWG	2 1/0 AWG	3 1/0 AWG	3 1/0 AWG	4 1/0 AWG	4 1/0 AWG	4 1/0 AWG	4 1/0 AWG	4 1/0 AWG	4 1/0 AWG	4 1/0 AWG	4 1/0 AWG	4 1/0 AWG
-	70 ft. (21.3 M)	1 AWG	0 AWG	2 1/0 AWG	2 1/0 AWG	3 1/0 AWG	3 1/0 AWG	4 1/0 AWG	4 1/0 AWG	4 1/0 AWG	4 1/0 AWG	4 1/0 AWG	4 1/0 AWG	4 1/0 AWG	4 1/0 AWG	4 1/0 AWG	4 1/0 AWG	4 1/0 AWG
-	80 ft. (24.4 M)	0 AWG	2 1/0 AWG	2 1/0 AWG	2 1/0 AWG	3 1/0 AWG	3 1/0 AWG	4 1/0 AWG	4 1/0 AWG	4 1/0 AWG	4 1/0 AWG	4 1/0 AWG	4 1/0 AWG	4 1/0 AWG	4 1/0 AWG	4 1/0 AWG	4 1/0 AWG	4 1/0 AWG
-	90 ft. (27.4 M)	2 1/0 AWG	2 1/0 AWG	2 1/0 AWG	2 1/0 AWG	3 1/0 AWG	3 1/0 AWG	4 1/0 AWG	4 1/0 AWG	4 1/0 AWG	4 1/0 AWG	4 1/0 AWG	4 1/0 AWG	4 1/0 AWG	4 1/0 AWG	4 1/0 AWG	4 1/0 AWG	4 1/0 AWG
-	100 ft. (30.5 M)	2 1/0 AWG	2 1/0 AWG	2 1/0 AWG	2 1/0 AWG	3 1/0 AWG	3 1/0 AWG	4 1/0 AWG	4 1/0 AWG	4 1/0 AWG	4 1/0 AWG	4 1/0 AWG	4 1/0 AWG	4 1/0 AWG	4 1/0 AWG	4 1/0 AWG	4 1/0 AWG	4 1/0 AWG
-	110 ft. (33.5 M)	2 1/0 AWG	2 1/0 AWG	2 1/0 AWG	2 1/0 AWG	3 1/0 AWG	3 1/0 AWG	4 1/0 AWG	4 1/0 AWG	4 1/0 AWG	4 1/0 AWG	4 1/0 AWG	4 1/0 AWG	4 1/0 AWG	4 1/0 AWG	4 1/0 AWG	4 1/0 AWG	4 1/0 AWG
-	120 ft. (36.6 M)	2 1/0 AWG	2 1/0 AWG	2 1/0 AWG	2 1/0 AWG	3 1/0 AWG	3 1/0 AWG	4 1/0 AWG	4 1/0 AWG	4 1/0 AWG	4 1/0 AWG	4 1/0 AWG	4 1/0 AWG	4 1/0 AWG	4 1/0 AWG	4 1/0 AWG	4 1/0 AWG	4 1/0 AWG
-	130 ft. (39.6 M)	2 1/0 AWG	2 1/0 AWG	2 1/0 AWG	2 1/0 AWG	3 1/0 AWG	3 1/0 AWG	4 1/0 AWG	4 1/0 AWG	4 1/0 AWG	4 1/0 AWG	4 1/0 AWG	4 1/0 AWG	4 1/0 AWG	4 1/0 AWG	4 1/0 AWG	4 1/0 AWG	4 1/0 AWG

### AWG WIRE SIZE CHART

Circles indicate actual diameter of wire (not including insulation)

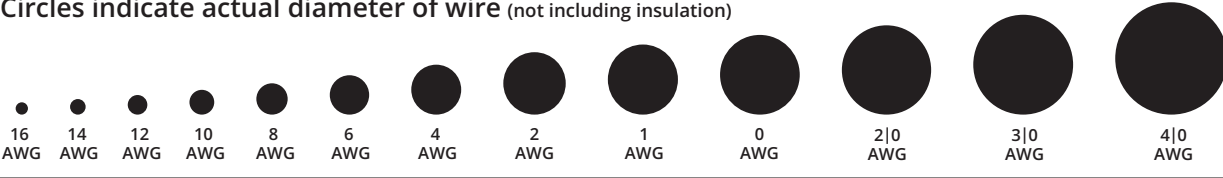

Although this process uses information from ABYC E-11 to recommend wire size and circuit protection, it may not cover all of the unique characteristics that may exist on a boat. If you have specific questions about your installation please consult an ABYC certified installer.

## 2. Choose the Correct Fuse and Fuse Amperage

a) Choose a fuse type by following the line of the AWG WIRE SIZE determined from the Wire Selection Chart

Appropriate fuses will have an amperage that intersects the AWG Wire Size line.

b) The appropriate fuse amperage will be found in one of the four gray bars below the fuse type

- Single Wire, Outside Engine Room = First column dark gray bar
- Single Wire, Inside Engine Room = First column light gray bar
- Bundled Wire, Outside Engine Room = Second column dark gray bar
- Bundled Wire, Inside Engine Room = Second column light gray bar

**Example:** For a 4 AWG single 105°C rated wire outside an engine room, the maximum fuse amperage is 150A.

**Note:** Possible fuse amperages for a circuit can fall between a range of maximum and minimum fuse amperages. The procedure in step 1 calculates the maximum fuse amperage which reduces nuisance blows but may offer less protection than a lower amperage fuse. The minimum fuse amperage is calculated by multiplying the current flow in amps by 125%. If the product instructions specify a fuse amperage, use that value if it is under the maximum amperage found in the step 1 procedure. If the specified fuse amperage is over the maximum suggested, move down the column and choose the wire size that intersects with the specified fuse amperage.

Calculations are based on 105°C wire. For more detailed calculations, download the Circuit Wizard app or go to [circuitwizard.blueseas.com](http://circuitwizard.blueseas.com)

Fuse types selected should be verified to carry an ampere interrupting capacity (AIC) that meets the requirements of ABYC E-11.10.1.2.2 or E-11.10.1.2.3, based on the total capacity of the battery or battery bank supplying current through the fuse. This should include all batteries or banks that could be put in parallel through the use of a battery selection, or cross connection switch if the fuse is installed on the load side of the switch.

### FUSE SELECTION CHART

AWG WIRE SIZE	AGC® MDL® Fuse		ATO® or ATC® Fuse		MAXI® Fuse		AMI® or MIDI® Fuse		MRBF™ Terminal Fuse		MEGA® or AMG® Fuse		CLASS T Fuse		CLASS T Fuse		ANL® Fuse		
	SINGLE WIRE	BUNDLED WIRES	SINGLE WIRE	BUNDLED WIRES	SINGLE WIRE	BUNDLED WIRES	SINGLE WIRE	BUNDLED WIRES	SINGLE WIRE	BUNDLED WIRES	SINGLE WIRE	BUNDLED WIRES	SINGLE WIRE	BUNDLED WIRES	SINGLE WIRE	BUNDLED WIRES	SINGLE WIRE	BUNDLED WIRES	
16 AWG	25A	20A	20A	15A	25A	20A	20A	15A											
14 AWG	30A	25A	20A	30A	25A	20A													
12 AWG		30A	25A		30A	25A													
10 AWG					30A	25A													
8 AWG					60A	50A	40A	40A	60A	50A	40A	40A							
6 AWG					80A	70A	60A	50A	80A	70A	60A	50A							
4 AWG					80A	70A	60A	50A	125A	100A	80A	70A	125A	100A					
2 AWG					150A	125A	100A	100A	150A	125A	100A	100A	150A	125A	100A	110A			
1 AWG					200A	175A	150A	125A	200A	175A	150A	125A	200A	175A	150A	125A			
0 AWG					200A	175A	150A	250A	200A	175A	150A	250A	200A	175A	150A	250A			
2/0 AWG					200A	175A	300A	250A	300A	250A	200A	175A	300A	250A	200A	250A	350A	300A	225A
3/0 AWG																	350A	300A	225A
4/0 AWG																	400A	350A	250A

### Fuse Scale Comparison

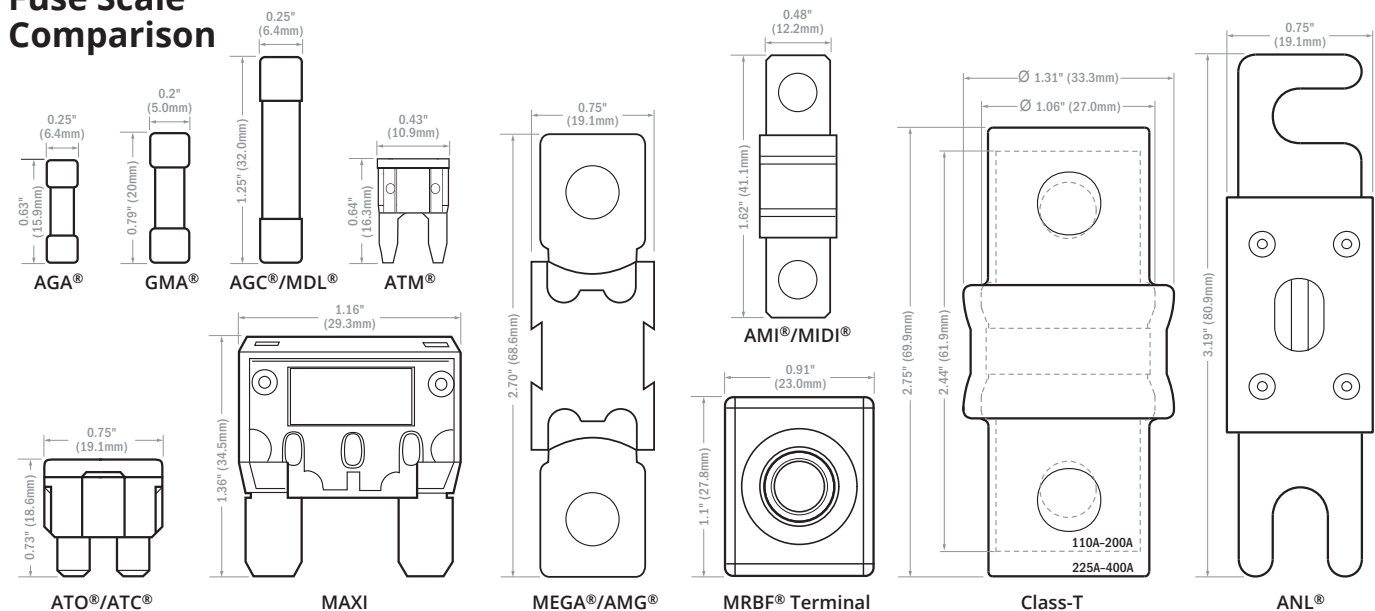





# Battery Management Wiring Schematics for Typical Applications

Batteries are at the heart of the electrical system found on any boat or vehicle. Proper battery management, including switching and charging, is essential for safe and reliable operation. The following wiring diagrams show how batteries, battery switches, and Automatic Charging Relays are wired together from a simple 1 battery - 1 engine configuration to a 4 battery - 2 engine - 1 generator system. For more detailed wiring guidelines please consult a qualified marine electrician or one of the many books available on the subject.

Note: The ACRs pictured are representative of any ACR. The battery switches are representative of any battery switch of the same contact configuration.

## 1 Battery - 1 Engine

Switches a single battery to a single load group.

ON-OFF Battery Switch

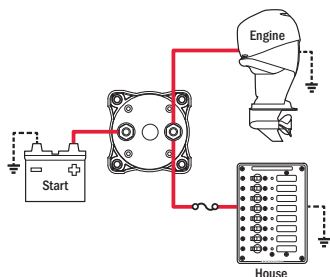

## Saves battery power for starting.

1 ON-OFF Battery Switch  
1 Low Voltage Disconnect

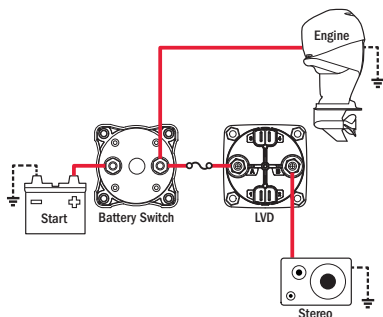

## 2 Battery - 1 Engine

Switches isolated battery banks to all loads or combines battery banks to all loads.

1 Selector Battery Switch  
1 Automatic Charging Relay

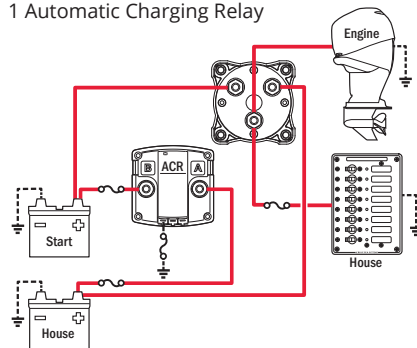

Note:  
Uses same style batteries

Simultaneously switches two isolated battery banks or combines battery banks to all loads.

1 Dual Circuit Plus™ Battery Switch  
1 Automatic Charging Relay

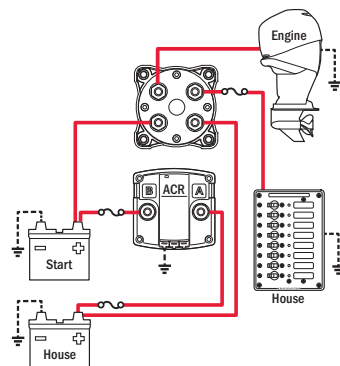

Can isolate a failed battery.

3 ON-OFF Battery Switches  
1 Automatic Charging Relay

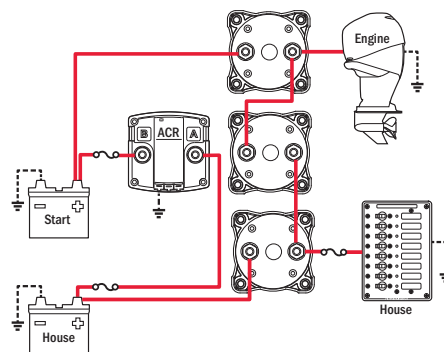

## 2 Battery - 2 Engine

House battery is shared with one engine. One engine battery is in reserve.

2 Selector Battery Switches  
1 Automatic Charging Relay

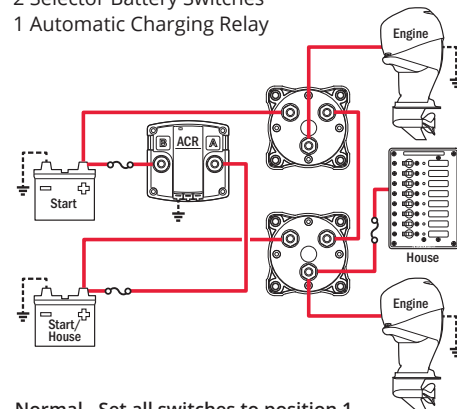

Normal - Set all switches to position 1  
Parallel - Set all switches to position 1+2  
Isolate - Set Load switch to position 2 and Source Switch to position 1+2

Engines share one battery. House battery is in reserve.

1 Dual Circuit Plus™ Battery Switch  
1 Automatic Charging Relay

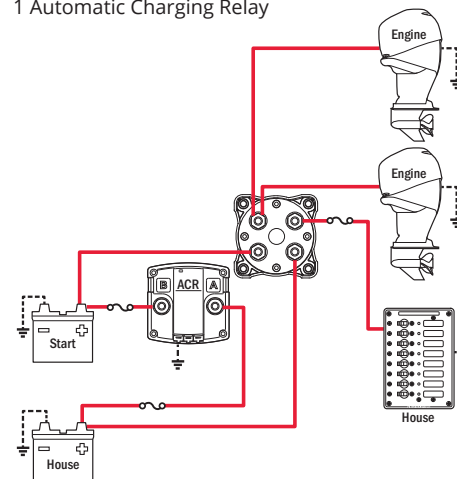

Can isolate a failed battery.

3 ON-OFF Battery Switches  
1 Automatic Charging Relay

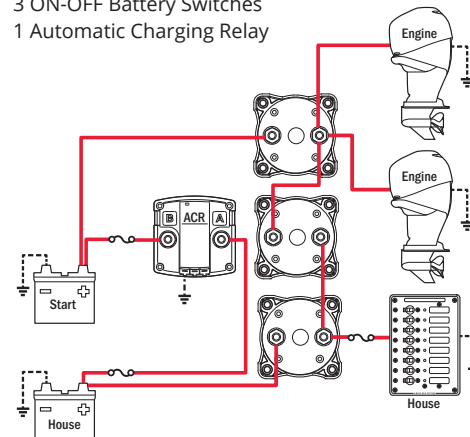

### 3 Battery - 2 Engine

Can isolate any battery source from any batteries.

- 3 Selector Battery Switches
- 2 Automatic Charging Relays

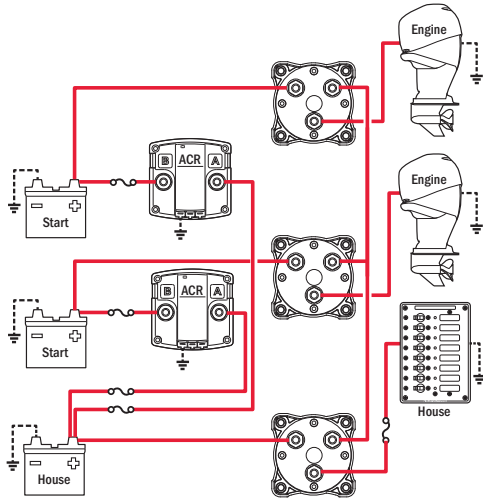

- Normal - Set all switches to position 1
- Parallel - Set all switches to position 1+2
- Isolate - Set Load switch to position 2 and Source Switch to position 1+2

Can parallel batteries for extra starting power.

- 2 Dual Circuit Plus™ Battery Switches
- 2 Automatic Charging Relays

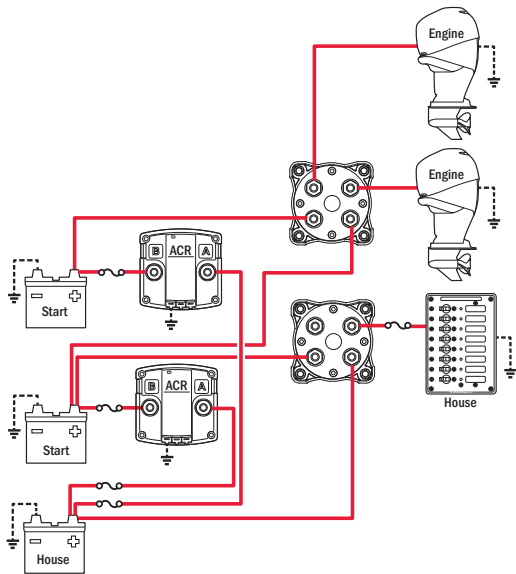

#### LEGEND

- DC Positive ———
- DC Ground - - - - -

The diagrams above are intended for reference only. Consult an ABYC certified marine electrical professional for system design and circuit protection.

### 4 Battery - 2 Engine - 1 Generator

Can isolate any battery source from any batteries.

- 4 Selector Battery Switches
- 3 Automatic Charging Relays

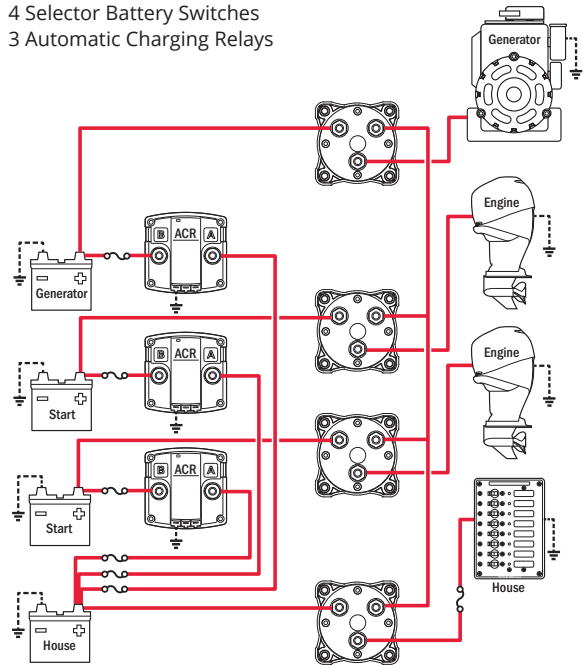

- Normal - Set all switches to position 1
- Parallel - Set all switches to position 1+2
- Isolate - Set Load switch to position 2 and Source Switch to position 1+2

Can parallel batteries for extra starting power.

- 3 Dual Circuit Plus™ Battery Switches
- 3 Automatic Charging Relays

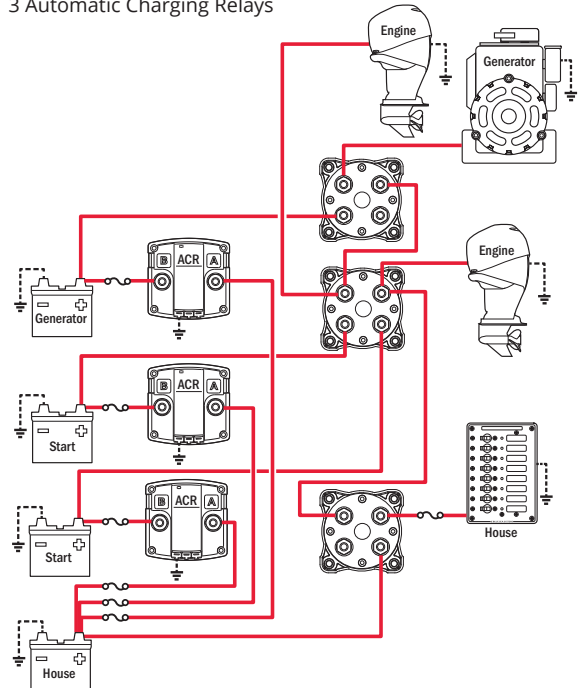

# DC Main Circuit Protection and Branch Circuit Protection

## Purpose

Fuses and circuit breakers are used to protect wire insulation from melting and starting fires in the event of overcurrents or short circuits which cause more amperage to flow in a wire than that wire is rated to carry. It is important to note that, except for those wires that are intended to carry starting currents, every positive wire in the DC Main Power Distribution System must be protected by a fuse or circuit breaker.

## Considerations for DC Main Circuit Protection

### Mounting Placement – distance from power source.

The DC Main circuit protection system uses circuit breakers or fuses to protect the wires of the DC Main distribution system. The American Boat and Yacht Council (ABYC) publishes voluntary standards for the type and placement of the fuse or circuit breaker to be used as a DC Main circuit protection device. Wire intended to carry engine starting currents between the batteries, the switch, and the starter is not required to have main circuit protection devices installed. Maximum mounting placement dimensions for a fuse or circuit breaker are 7" if the conductor is not housed in a sheath or enclosure in addition to the wire insulation, 40" if the conductor is housed in a sheath or enclosure in addition to the wire insulation, and 72" if the conductor is connected directly to the battery and housed in a sheath or enclosure in addition to the wire insulation.

### Selecting DC Main Circuit Protection

The principal attribute of a DC Main circuit protection device is its Ampere Interrupt Capacity (AIC) rating. Specifications listed in the ABYC standards determine the AIC a DC Main circuit protection device must have. The required AIC rating is determined by the total CCA of the batteries connected to the circuit. See the tables at right for the required AIC ratings.

Wire selection for DC applications on boats is usually based on voltage drop requirements. However, there is a maximum continuous current that the wire can withstand without overheating. Higher grade marine wires are rated for service up to 105°C (221°F)—the ABYC wire capacity table for 105°C is most frequently quoted. The 105°C table accurately reflects the capacity of single conductors exposed to freely circulating cooling air. However, other factors, such as covering bundles of wire in outer jackets to form a cable, or use of conduits or structural voids to protect wires, can reduce the cooling and reduce the safe capacity of the wire. A more conservative strategy is to use the 105°C wire, but treat it according to the 75°C table above when selecting circuit protection unless the wire is openly exposed for cooling.

See the Blue Sea Systems Circuit Wizard at [circuitwizard.blueseasea.com](http://circuitwizard.blueseasea.com) or pages 159-161 for more assistance with wire and circuit protection selection.

## ABYC Interrupt Rating Table

Total Connected Battery Cold Cranking Amperes (CCA) *	Ampere Interrupt Capacity	
12V AND 24V		
The white boxes identify two batteries, of the same size, placed in parallel configuration.	DC MAIN	DC BRANCH
650 CCA or Less	1,500 AIC	750 AIC
651-1,100 CCA	3,000 AIC	1,500 AIC
1,101-2,200 CCA	5,000 AIC	2,500 AIC
>2,200 CCA	20,000 AIC @ 125V DC or battery short circuit rating	3,000 AIC
32V		
1,250 CCA or Less	3,000 AIC	1,500 AIC
Over 1,250 CCA	5,000 AIC	2,500 AIC

\* Battery cold cranking performance rating at -17.8°C (0°F): The discharge load in amps that a battery at -17.8°C (0°F) can deliver for 30 seconds, and maintain a voltage of 1.2V per cell or higher, (e.g. 7.2V for a 12V battery). The CCA for the battery icons in this chart is an approximation and could be slightly higher or lower. Consult the battery manufacturer's specifications for precise CCA ratings. A battery rated in MCA will have a CCA capacity approximately 80% of MCA

ABYC E-11 requires the use of circuit breakers that can be reused and reset and that they be applied as per the table above. The standard does not strictly require that fuses be applied in the same way, but it is an issue to consider, especially with high amp fuses used to protect panel feeders or inverters. Fuses under 10 Amp rating generally have such a high internal resistance they prevent fault currents from reaching 1000 Amps in 12 Volt circuits. The apparent contradiction when using these fuses for bilge pumps and other circuits directly off the battery is less of an issue than it might seem. If a fuse blows, and the case appears to be cracked or metal has been ejected, the fuse holder should be replaced.

## ABYC Ampacity Rating Table at 30°C †

WIRE SIZE		TEMPERATURE RATING OF CONDUCTOR INSULATION								REFERENCE DATA						
Standard AWG	Metric mm <sup>2</sup>	75°C		90°C		105°C		75°C		90°C		105°C		mm dia	Ohms /1000ft	Ohms /1000m
		Eng Rm	Eng Rm	Eng Rm	Eng Rm	Eng Rm	Eng Rm	Eng Rm	Eng Rm	Eng Rm	Eng Rm					
18	0.75	9.5	7	19	15.5	19	16	6.6	5.0	13	11	13	11	0.98	7.29	23.92
18	0.82	10	8	20	16	20	17	7	5	14	12	14	12	1.02	6.67	21.88
18	1.0	13	10	21	17	21	18	9	7	15	12	15	13	1.13	5.47	17.94
16	1.3	15	11	25	21	25	21	11	8	18	14	18	15	1.29	4.17	13.70
16	1.5	16	12	24	20	29	24	11	9	17	14	20	17	1.38	3.65	11.96
14	2.1	20	15	30	25	35	30	14	11	21	17	25	21	1.63	2.63	8.63
14	2.5	21	16	34	28	38	32	15	11	23	19	26	22	1.78	2.19	7.18
12	3.3	25	19	40	33	45	38	18	13	28	23	32	27	2.05	1.65	5.42
12	4.0	34	25	46	38	51	43	24	18	32	27	35	30	2.26	1.37	4.49
10	5.3	40	30	55	45	60	51	28	21	39	32	42	36	2.59	1.04	3.41
10	6.0	53	40	57	47	65	55	37	28	40	33	45	39	2.76	0.91	2.99
8	8.4	65	49	70	57	80	68	46	34	49	40	56	48	3.27	0.65	2.14
8	10.0	79	60	84	69	100	85	56	42	59	48	70	60	3.6	0.55	1.79
6	13.3	95	71	100	82	120	102	67	50	70	57	84	71	4.1	0.41	1.35
6	16.0	105	79	113	93	134	114	73	55	79	65	94	80	4.5	0.34	1.12
4	21	125	94	135	111	160	136	88	66	95	78	112	95	5.2	0.26	0.85
4	25	141	106	150	123	175	148	99	74	105	86	122	104	5.6	0.22	0.72
3	27	145	109	155	127	180	153	102	76	109	89	126	107	5.8	0.21	0.67
2	34	170	128	180	148	210	179	119	89	126	103	147	125	6.5	0.16	0.53
2	35	173	130	186	153	217	185	121	91	130	107	152	129	6.7	0.16	0.51
1	42	195	146	210	172	245	208	137	102	147	121	172	146	7.3	0.13	0.42
0	50	220	165	235	193	273	232	154	116	164	135	191	163	8.0	0.109	0.36
00	54	230	173	245	201	285	242	161	121	172	141	200	170	8.3	0.102	0.34
00	68	265	199	285	234	330	281	186	139	200	164	231	196	9.3	0.081	0.27
00	70	274	206	292	239	341	289	192	144	204	168	238	203	9.4	0.078	0.26
000	85	310	233	330	271	385	327	217	163	231	189	270	229	10.4	0.064	0.21
000	95	334	251	357	293	413	351	234	175	250	205	289	246	11.0	0.058	0.19
0000	107	360	270	385	316	445	378	252	189	270	221	312	265	11.7	0.051	0.17
0000	120	387	290	414	339	478	406	271	203	290	237	335	284	12.4	0.046	0.15
0000	150	445	333	476	390	550	467	311	233	333	273	385	327	13.8	0.036	0.12

Data based on E-11 Table VI-A (single conductors in free air) Data based on E-11 Table VI-B (Up to three conductors in a sheath, conduit or bundle)

SAE conductors are smaller than equivalent AWG by 5% to 12% with current capacity typically less by 7%. ISO Ratings for metric wire are slightly less than these values derived from ABYC VI-A ratings.

- For bundles of 4 to 6 conductors multiply by 0.857
- For bundles of 7 to 24 conductors multiply by 0.714
- For bundles of 25 or more, conductors multiply by 0.571

### Wires counted in bundles need not include:

1. Wires carrying intermittent currents no more than rating per VI-A and for less than one minute per mm of diameter, and not repeating more often than a delay of 5X times active duration.
2. Wires carrying load currents at less than 50% of the wire rating per table VI-B.

† Thermally limited amperage capacity



# AC Main Power Distribution and Circuit Protection

## Purpose

- Provide a path for delivering power from the ship's sources of AC power to the AC branch distribution system
- Provide a path for returning fault currents to ground via the green safety Ground wire
- Provide a means for disconnecting AC power when the boat is not in use or in emergencies
- Provide electrical separation to insure that two sources of AC power are never connected
- Provide circuit protection for neutral and line wires in the AC main system
- Provide ground fault protection
- Provide ELCI overload or leakage fault protection

## AC Wire Systems

The three most common AC systems used on boats are shown here. In all cases the ground, sometimes called safety ground to clarify its purpose and differentiate it from the DC ground or negative, is said to be a "normally non-current carrying wire." Its purpose is to provide the lowest resistance path for AC currents that have strayed from their proper containment in the normally current carrying hot and neutral wires. The ground wire is connected to the exterior conductive parts of AC devices that could be touched by a person during normal operation, and it conducts errant AC currents safely to ground rather than passing them through a human body. The ground wire is never passed through a circuit breaker.

120 Volt-60 Hz	120/240 Volt-60 Hz	230 Volt-50 Hz
Hot	Hot 1	Hot
Neutral	Hot 2	Neutral
Ground	Neutral	Ground
	Ground	

## Devices Qualifying as AC Main Circuit Breakers

In order to qualify as an AC main circuit breaker, these characteristics must be present:

1. The circuit breaker must have an Amperage Interrupt Capacity (AIC) meeting the requirements of the following tables.
2. The circuit breaker must be multiple pole, usually 2 or 3.
3. The circuit breaker must be rated for the appropriate AC system voltage in which it will be used.
4. The circuit breaker must be available in amperages appropriate to the design amperage of the system. In the USA, this is generally 30A and 50A, while European systems are generally 16A and 32A.
5. The ELCI shall have a leakage trip mechanism that trips if current exceeding 30mA leaks to ground.

AC Shore Power Source	Main Circuit Breaker	Branch Circuit Breaker
120V - 30A	3,000	3,000
120V - 50A	3,000	3,000
120/240V - 50A	5,000	3,000
240V - 50A	5,000	3,000

Sources of AC power, whether shore power or onboard generators and inverters, should always have a circuit breaker near the power source. This circuit breaker is designated the AC main circuit breaker. The AC main circuit breaker should always have a pole for each of the hot and neutral wires in the circuit assuring that circuit protection functions are not compromised in reverse polarity situations. Beginning in July 2010 ABYC Standards require that an Equipment Leakage Circuit Interrupter (ELCI) with a 30mA leakage trip be installed in shore power applications as the first protective device after the power inlet. ELCIs respond to leakage of electrical current outside of the intended current path, and provide overload and short circuit protection. They serve as the main AC circuit breaker for the system. These devices will open all energized conductors and the neutral when opened manually or tripping on an overload or leakage fault. For a more complete discussion of ELCIs, see page 88.

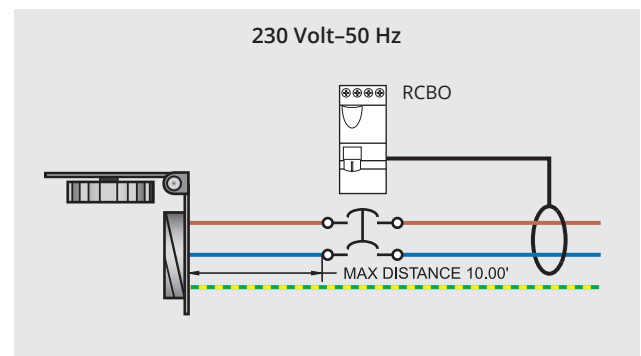
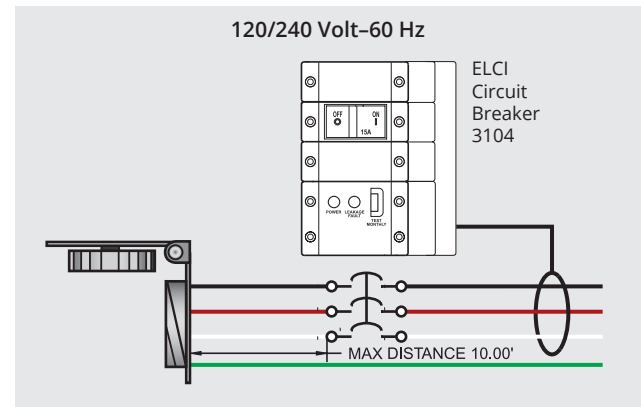
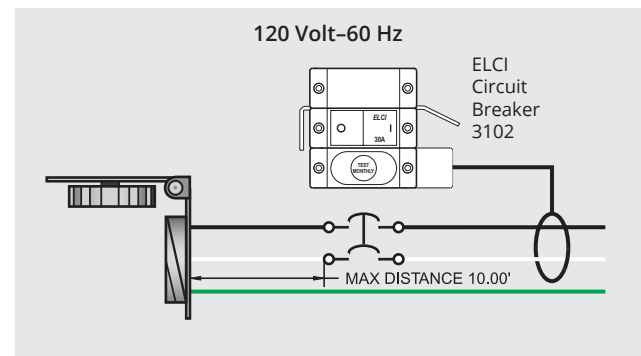

Part #	Page	Part #	Page	Part #	Page	Part #	Page	Part #	Page
1001	109	1221	120	1505	123	2105	102, 107	2410	103, 107
1001100	109	1222	120	1510	149	2107	104, 107	2502	103, 107
1002	109	1223	119	1518	152	2126	102, 107	2504	103, 107
1002100	109	1225	119	1520	94	2127	102, 107	2506	103, 107
1003	109	1227	119	1521	20	2128	102, 107	2508	103, 107
1003100	109	1228	124	1522	94	2129	75, 90	2510	103, 107
1007	109	1229	124	1525	142	2130	75, 90	2512	103, 107
1007100	109	1230	122	1698	153	2131	75, 90	2602	103, 107
1010	25	1231	127	1732	145, 148	2132	75, 90	2604	103, 107
1011	25	1232	127	1732200	145, 148	2133	75, 90	2606	103, 107
1011200	25	1233	122	1733	145, 148	2134	75, 90	2608	103, 107
1012	25	1331	152	1733200	145, 148	2135	75, 90	2610	103, 107
1014	25	1408	38	1739	145, 148	2136	75, 90	2701	101, 107
1015	25	1450	118	1739200	145, 148	2137	75, 90	2702	101, 107
1016	24	1455	118	1741	145, 148	2138	76, 90	2708	104
1016200	24	1456	118	1741200	145, 148	2139	76, 90	2709	101, 107
1035	25	1457	118	1810	144	2140	76, 90	2710	101, 107
1036	25	1459	118	1811	144	2141	76, 90	2713	100, 107
1038	25	1461	119	1820	149	2142	76, 90	2715	101, 107
1039	24	1463	119	1821	149	2143	76, 90	2716	101, 107
1044	24	1464	119	1829	149	2145	93, 97	2718	102
1045	24	1472	25	1830	143, 148	2146	93, 97	2719	102
1046	25	1473	140	1832	143, 148	2151	68	2722	101, 107
1070	152	1474	146	1833	143, 148	2155	93, 97	2723	101, 107
11001	32, 36	1475	147	1837	143, 148	2201	106, 107	2730B	104
11003	34, 36	1477	78, 90	1838	143, 148	2202	106, 107	2731B	104
1139	30	1478	25	1839	143, 148	2203	106, 107	3000	34, 36
1147	94	1479	152	1842	143, 148	2204	106, 107	3001	34, 36
1148	94	1479100	152	1850	142, 148	2300	101, 107	3002	34, 37
1168	125	1480	129	1990	104, 107	2301	101, 107	3003	34, 37
1190	126	1481	128	1991	104, 107	2302	101, 107	3091	87, 91
1193	126	1482	128	1992	104, 107	2303	101, 107	3092	87, 91
1200	119	1483	128	1993	104, 107	2304	100, 107	3093	87, 91
1201	120	1484	128	2001	106, 107	2305	100, 107	3102100	87, 91
1202	123	1485	128	2002	106, 107	2306	100, 107	3103	87, 91
1203	123	1486	128	2003	106, 107	2307	101, 107	3104	87, 91
1206	122	1487	129	2010	106, 107	2312	101, 107	3106100	87, 91
1207	122	1488	129	2011	106, 107	2314	100, 107	3113	88
1208	127	1489	129	2016	106, 107	2315	100, 107	3116	88
1209	127	1494	38	2017	106, 107	2340	105, 107	3117	88
1210	124	1495	118	2017100B	106, 107	2341B	105, 107	3118	88
1211	124	1496	119	2018	106, 107	2342B	105, 107	3119	88
1214	122	1497	118	2019	102, 107	2356	100, 107	3120	88
1215	122	1498	118	2020	102, 107	2356100	100, 107	3121	88
1216	118	1499	152	2101	106, 107	2402	103, 107	3122	89
1217	119	1502	126	2102	106, 107	2404	103, 107	3123	88
1218	130	1503	126	2103	106, 107	2406	103, 107	3124	89
1219	130	1504	126	2104	104, 107	2408	103, 107	3125	89

Part #	Page	Part #	Page	Part #	Page	Part #	Page	Part #	Page
3126	89	4150	96, 97	5023	63	5124	59	5210	56
3128	89	4151	96, 97	5024	63	5125	59	5210100	56
3130	89	4152	96, 97	5025	66	5126	59	5211	56
3131	82	4153	96, 97	5026	66	5127	59	5212	56
3133	89	4154	96, 97	5028	66	5128	59	5213	56
3134	89	4155	96, 97	5029	66	5129	59	5213100	56
3135	89	4160	95, 97	5030	66	5131	59	5215	56
4000	108	4161	95, 97	5031	66	5133	59	5215100	56
4001	108	4162	95, 97	5032	65	5135	59	5217	56
4002	108	4163	95, 97	5033	66	5136	59	5217100	56
4003	108	4180	95, 97	5034	66	5137	59	5218	56
4004	108	4181	95, 97	5035	64	5138	57	5218100	56
4005	108	4215	154	5037	64	5139	57	5219	56
4006	108	4216	154	5045	67	5140	57	5219100	56
4008	108	4217	154	5046	67	5141	57	5220	56
4009	108	4218	154	5049	74	5142	57	5220100	56
4010	108	4230	95	5050	74	5143	57	5226	56
4011	108	4302	115	5051	74	5161	59	5227	56
4012	108	4303	115	5052	74	5163	59	5228	56
4013	108	4304	115	5054	74	5164	59	5229	56
4014	108	4305	115	5056	62	5165	59	5230	56
4015	108	4306	115	5056100	62	5175	58	5231	56
4016	108	4307	115	5060	60	5176	58	5232	56
4017	108	4308	115	5061	60	5177	58	5233	56
4018	108	4309	115	5062	60	5178	58	5234	56
4019B	108	4320	113	5063	60	5180	58	5235	57
4020B	108	4321	113	5064	60	5181	58	5235100	57
4026	152	4322	113	5065	60	5182	58	5236	57
4027	152	4323	113	5068	60	5183	58	5236100	57
4028	152	4324	113	5101	58	5184	58	5237	57
4029	152	4325	113	5102	58	5185	58	5237100	57
4031	152	4363	26	5103	58	5186	58	5238	57
4100	153	4364	26	5104	58	5187	58	5239	57
4111	96	4365	26	5105	58	5189	58	5239100	57
4112	96	4366	26	5107	58	5190	58	5240	57
4113	152	4367	26	5108	58	5191	68	5240100	57
4116	96	4368	26	5112	59	5194	68	5241	57
4117	96	4369	26	5113	59	5196	68	5241100	57
4119	96	4374	115	5114	59	5202	56	5242	57
4125	153	4376	115	5115	59	5204	56	5242100	57
4126	153	4378	115	5116	59	5204100	56	5243	57
4130	153	5001	68	5117	59	5205	56	5243100	57
4131	153	5006100	61	5118	59	5206	56	5244	57
4134	76	5007100	69	5119	59	5206100	56	5244100	57
4135	75, 90	5015	61	5120	59	5207	56	5245	57
4136	75, 90	5018	61	5121	59	5208	56	5245100	57
4137	75, 90	5021	60	5122	59	5208100	56	5246	57
4138	96	5022	60	5123	59	5209	56	5250	58



Part #	Page	Part #	Page	Part #	Page	Part #	Page	Part #	Page
5251	58	6004200	30	6526-1035	154	7081	78, 90	7206	82, 90
5252	58	6005	30, 36	6526-1036	154	7082	78, 90	7208	82, 90
5253	58	6005200	30	6526-1037	154	7083	78, 90	7209	82, 90
5254	58	6006	30, 36	6526-1038	154	7084	78, 90	7210	82, 90
5255	58	6006200	30	6526-1039	154	7085	78, 90	7212	82, 90
5256	58	6007	30, 37	6526-1040	154	7086	78, 90	7213	82, 90
5257	58	6007200	30	6526-1041	154	7087	78, 90	7214	82, 90
5258	58	6008	30, 36	6526-1042	154	7088	78, 90	7216	82, 90
5259	58	6008200	30	6526-1043	154	7089	78, 90	7217	82, 90
5260	58	6010	30, 37	6526-1044	154	7098	78, 90	7218	82, 90
5261	57	6010200	30	6526-1045	154	7135	79, 90	7220	82, 90
5262	57	6011	30, 37	6526-1046	154	7136	79, 90	7221	82, 90
5263	57	6011200	30	6526-1047	154	7138	79, 90	7222	82, 90
5264	57	6337	129	6526-1048	154	7139	79, 90	7224	82, 90
5265	57	6526-1001	154	6526-1049	154	7140	79, 90	7225	82, 90
5270	57	6526-1002	154	6526-1050	154	7141	79, 90	7226	82, 90
5271	57	6526-1003	154	6526-1051	154	7142	79, 90	7228	82, 90
5272	57	6526-1004	154	7035	79, 90	7143	79, 90	7229	82, 90
5273	57	6526-1005	154	7036	79, 90	7144	79, 90	7230	82, 90
5274	57	6526-1006	154	7038	79, 90	7146	79, 90	7232	82, 90
5275	56	6526-1007	154	7039	79, 90	7147	79, 90	7233	82, 90
5280	56	6526-1008	154	7040	79, 90	7148	79, 90	7234	82, 90
5281	56	6526-1009	154	7041	79, 90	7149	79, 90	7235	82, 90
5282	56	6526-1010	154	7042	79, 90	7151	77, 90	7236	82, 90
5283	56	6526-1011	154	7043	79, 90	7152	77, 90	7237	82, 90
5284	56	6526-1012	154	7044	79, 90	7153	77, 90	7238	82, 90
5285	56	6526-1013	154	7046	79, 90	7154	77, 90	7239	82, 90
5286	57	6526-1014	154	7047	79, 90	7155	77, 90	7240	82, 90
5287	57	6526-1015	154	7048	79, 90	7156	77, 90	7241	82, 90
5288	56	6526-1016	154	7049	79, 90	7157	77, 90	7242	82, 90
5289	56	6526-1017	154	7050	75, 90	7160	77, 90	7244	84, 90
5290	57	6526-1018	154	7052	75, 90	7180	78, 90	7246	84, 90
5291	57	6526-1019	154	7053	75, 90	7181	78, 90	7248	84, 90
5292	57	6526-1020	154	7054	75, 90	7182	78, 90	7250	84, 90
5293	57	6526-1021	154	7056	75, 90	7183	78, 90	7250I	84, 90
5294	57	6526-1022	154	7057	75, 90	7184	78, 90	7251	84, 91
5295	57	6526-1023	154	7058	75, 90	7185	78, 90	7254	84, 91
5296	57	6526-1024	154	7059	75, 90	7186	78, 90	7256	84, 91
5297	57	6526-1025	154	7061	75, 90	7187	78, 90	7258	84, 91
5298	57	6526-1026	154	7062	77, 90	7188	78, 90	7260	82, 90
5299	57	6526-1027	154	7063	77, 90	7189	78, 90	7267	84, 91
5502	69	6526-1028	154	7064	77, 90	7197	82, 90	7268	84, 91
5502100	69	6526-1029	154	7065	77, 90	7198	78, 90	7269	84, 91
5503	69	6526-1030	154	7066	77, 90	7200	82, 90	7270	84, 91
5505	69	6526-1031	154	7067	77, 90	7201	82, 90	7271	84, 91
5510E	32, 37	6526-1032	154	7068	77, 90	7202	82, 90	7287	84, 91
5511E	32, 37	6526-1033	154	7069	76	7204	82, 90	7288	84, 91
6004	30, 36	6526-1034	154	7080	78, 90	7205	82, 90	7289	84, 91

Part #	Page	Part #	Page	Part #	Page	Part #	Page	Part #	Page
7290	84, 91	7441	81, 90	7545	85, 90	7700	43, 52	7911	18
7294	82, 90	7442	81, 90	7546	85, 90	7700100	43	7912	18
7295	82, 90	7443	81, 90	7547	85, 90	7701	40, 52	7920	18
7299	82, 90	7444	81, 90	7548	85, 90	7701100	40	7921	18
7310	80, 90	7445	81, 90	7549	85, 90	7702	43, 52	7928	92, 97
7311	80, 90	7446	81, 90	7554	85, 91	7702100	43	7929	92, 97
7312	80, 90	7454	81, 90	7560	85, 91	7703	40, 52	7930	92, 97
7313	80, 90	7455	81, 90	7561	85, 91	7703100	40	7931	92, 97
7314	80, 90	7456	81, 90	7563	85, 91	7713	43, 52	7932	92, 97
7315	80, 90	7457	81, 90	7564	85, 91	7713100	43	7933	92, 97
7316	80, 90	7458	81, 90	7565	85, 91	7717	43, 52	7934	92, 97
7317	80, 90	7459	81, 90	7568	85, 91	7717100	43	7935	92, 97
7347	82, 90	7461	81, 90	7574	83, 90	7718	40, 52	7936	92, 97
7348	82, 90	7462	81, 90	7575	83, 90	7718100	40	7937	92, 97
7349	82, 90	7463	81, 90	7577	83, 90	7719	40, 52	7938	92, 97
7350	84, 90	7464	81, 90	7580	85, 91	7719100	40	7939	92, 97
7351	84, 90	7465	81, 90	7581	85, 91	7720	70, 73	7943	92, 97
7352	84, 90	7466	81, 90	7583	85, 91	7721	70, 73	7944	92, 97
7353	84, 90	7467	81, 90	7584	85, 91	7725	71, 73	7945	92, 97
7354	84, 90	7475	85, 91	7585	85, 91	7748	71, 73	8003	140, 148
7355	84, 90	7476	85, 91	7588	85, 91	7765	39, 52	8005	140, 148
7365	84, 91	7477	85, 91	7601	46, 53	7820	21	8013	147
7372	125	7480	94, 97	7603	22	7821	21	8015	140
7399	83, 90	7481	94, 97	7604	22	7822	21	8017	140, 148
7400	83, 90	7482	94, 97	7605	22	7823	21	8018	140, 148
7401	83, 90	7483	94, 97	7606	22	7824	21	8019	140, 148
7402	83, 90	7484	94, 97	7607	22	7825	21	8022	140, 148
7403	83, 90	7485	94, 97	7608	22	7830	21	8023	119
7404	83, 90	7490	94, 97	7609	22	7831	21	8025	118
7405	83, 90	7491	94, 97	7610	47, 53	7832	21	8027	122
7406	83, 90	7492	94, 97	7611	50, 53	7833	21	8028	140, 148
7407	83, 90	7493	94, 97	7615	41, 53	7834	21	8029	122
7408	83, 90	7494	94, 97	7620	51, 53	7840	21	8030	154
7410	83, 90	7495	94, 97	7620100	51	7841	21	8031	154
7411	83, 90	7504	27	7621	51, 53	7850	21	8032	127
7412	83, 90	7506	27	7621100	51	7850001	21	8033	153
7413	83, 90	7507	27	7622	51, 53	7851	21	8034	153
7414	83, 90	7508	27	7622100	51	7851001	21	8037	96
7415	83, 90	7509	27	7623	51, 53	7860	21	8039	154
7416	83, 90	7512	19	7623100	51	7870	158	8041	140, 148
7417	83, 90	7517	20	7635	40, 53	7900	30	8043	122
7425	83, 90	7520	20	7649	48	7900200	30	8051	146
7427	83, 90	7531	19	7649003	48	7901	30	8053	114
7428	83, 90	7532	19	7650	48	7901200	30	8054	114
7429	83, 90	7540	85, 90	7650003	48	7902	158	8058	124
7430	83, 90	7541	85, 90	7653	49	7903	30	8059	124
7433	83, 90	7542	85, 90	7654	49	7903200	30	8061	127
7440	81, 90	7543	85, 90	7655	49	7910	18	8066	153

Part #	Page	Part #	Page	Part #	Page	Part #	Page	Part #	Page
8067	154	8197	124	8265	125	8380	121	8580	124
8068	120	8199	122	8266	94	8381	121	8585	123
8072	82	8200	96, 97	8267	94	8382	121	8588	123
8073	149	8204	96, 97	8268	94	8385	119	8589	127
8074	123	8205	96, 97	8271	114	8386	129	8598	127
8076	123	8206	96, 97	8272	114	8401	118	8599	127
8077	122	8207	96, 97	8273	114	8402	119	8664	113
8079	122	8208	96, 97	8274	114	8403	120	8665	113
8080	38	8209	96, 97	8275	92, 97	8405	122	8666	113
8081	118	8210	96, 97	8278	93	8406	123	8686	38
8082	119	8211	96, 97	8280	38	8407	123	8689	38
8084	130	8212	96, 97	8282	92, 97	8408	131	8690	38
8086	131	8214	154	8283	92, 97	8409	122	8693	38
8087	84	8216	92, 97	8284	92, 97	8410	147	9001E	32, 37
8088	84	8217	154	8285	92, 97	8411	124	9002E	32, 37
8089	84	8218	92, 97	8286	92, 97	8412	122	9003E	32, 36
8095	130	8219	92, 97	8287	92, 97	8413	130	9004E	32, 36
8096	118	8220	92, 97	8288	92, 97	8421	114	9009	128
8097	124	8221	92, 97	8289	92, 97	8461	125	9010	128
8099	122	8222	92, 97	8290	92, 97	8462	127	9011	128
8100	126	8230	92, 97	8291	92, 97	8464	123	9012	39, 52
8101	126	8231	92, 97	8292	92, 97	8465	123	9019	129
8102	126	8232	92, 97	8293	93	8466	127	9030B	108
8110	145, 148	8233	92, 97	8294	93	8467	127	9031B	108
8120	118	8234	92, 97	8295	93	8478	124	9038B	108
8121	114	8235	146, 148	8296	93	8479	125	9039B	108
8127	122	8236	146, 148	8297	93	8480	124	9040B	108
8129	122	8237	147, 148	8298	93	8485	123	9041B	108
8132	127	8238	147, 148	8299	93	8488	123	9077	129
8134	153	8240	140, 148	8300	92, 97	8489	127	9093	129
8143	122	8244	141, 148	8357	128	8498	127	9159	30
8158	124	8245	141, 148	8358	128	8499	127	9160	43
8159	124	8246	141, 148	8359	128	8505	122	9176B	108
8161	127	8247	147, 148	8361	129	8506	123	9177B	108
8165	125	8248	146, 148	8363	129	8507	123	9216	103
8166	153	8251	146, 148	8365	128	8508	131	9217	103
8167	153	8252	140, 148	8366	128	8509	122	9218	103
8169	153	8253	140, 148	8367	128	8511	124	9228	149
8171	153	8255	149	8369	129	8512	122	9230	149
8172	153	8256	149	8371	114	8521	114	9231	149
8173	82	8257	149	8372	114	8561	125	9233	149
8174	123	8258	141, 148	8373	114	8562	127	9353	141, 148
8176	123	8259	94	8374	114	8564	123	9354	141, 148
8177	122	8260	94	8375	119	8565	123	9630	141, 148
8179	122	8261	114	8376	120	8566	127		
8184	130	8262	114	8377	120	8567	127		
8186	131	8263	113	8378	120	8578	124		
8195	130	8264	121	8379	120	8579	125		



# Ingress Protection (IP) Ratings Guide



## Example:







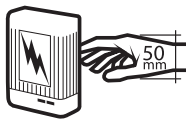
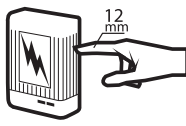
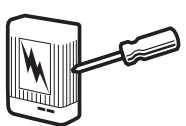
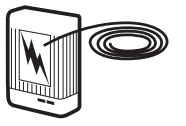

An IP65 rating can be determined using the adjacent table and example:

- The first number of the rating example, 6, in the gray column means the enclosure is dust tight
- The second number of the rating example, 5, in the blue column means the enclosure is protected against jets of water

The IP rating system was established by the International Electrotechnical Commission (IEC), an organization for international standards and conformity assessment. The IEC collaborates closely with the International Organization for Standardization (ISO). A complete description of the IP ratings and associated tests is found in IEC Publication 529. Although these ratings were initially developed as a way to classify enclosures, they now provide a convenient, practical way to compare levels of sealing. Many electrical products have an Ingress Protection (IP) rating which identifies the environmental factors needing consideration prior to the product's installation.

This is important when deciding when to mount products in a dry and clean environment versus a wet and/or dusty environment. The IP rating indicates the degree of protection provided. The numbers following IP represent levels of sealing and can range from no protection to full protection against dust and water. The table provides a description of the protection at each level.

SOLIDS	
1	 <p>Protected against a solid object greater than 50 mm such as a hand.</p>
2	 <p>Protected against a solid object greater than 12 mm such as a finger.</p>
3	 <p>Protected against a solid object greater than 2.5 mm such as a screwdriver.</p>
4	 <p>Protected against a solid object greater than 1 mm such as a wire.</p>
5	 <p>Dust Protected. Limited ingress of dust permitted. Will not interfere with operation of the equipment. Two to eight hours.</p>
6	 <p>Dust tight. No Ingress of dust. Two to eight hours.</p>

WATER	
1	 <p>Protected against vertically falling drops of water. Limited ingress permitted.</p>
2	 <p>Protected against vertically falling drops of water with enclosure tilted up to 15 degrees from the vertical. Limited ingress permitted.</p>
3	 <p>Protected against sprays of water up to 60 degrees from the vertical. Limited ingress permitted for three minutes.</p>
4	 <p>Protected against water splashed from all directions. Limited ingress permitted.</p>
5	 <p>Protected against jets of water. Limited ingress permitted.</p>
6	 <p>Water from heavy seas or water projected in powerful jets shall not enter the enclosure in harmful quantities.</p>
7	 <p>Protection against the effects of immersion in water between 15 cm and 1 m for 30 minutes.</p>
8	 <p>Protection against the effects of immersion in water under pressure for long periods.</p>

## Rating Example:



**Blue Sea Systems**

N85 W12545 Westbrook Crossing  
Menomonee Falls, WI 53051 USA  
p 800.307.6702  
p 800.222.7617 Blue Sea Systems  
f 800.799.3779

**New Zealand**

42 Apollo Drive  
Rosedale, Auckland 0632  
New Zealand  
p +64.9.415.7261  
f +64.9.415.9327

**The Netherlands**

Snijdersbergweg 93  
1105 AN Amsterdam  
The Netherlands  
p +31(0)20 34 22 100  
f +31(0)20 69 71 006

tech.blueseas@oneasg.com  
blueseas.com

© 2023 Navico Group. All Rights Reserved.  
Navico Group is a division of Brunswick Corporation.

®Reg. U.S. Pat. & Tm. Off, and ™ common law marks. Visit [www.navico.com/intellectual-property](http://www.navico.com/intellectual-property)  
to review the global trademark rights for Navico Group.

Unauthorized copying or reproduction is a violation of applicable laws.

BSS\_CAT\_001\_0523