



BEP

MARINE
EMERGENCY VEHICLE
INDUSTRIAL
RV

2024

NAVICO GROUP

TAKING YOU FURTHER

Navico Group is the world's leading supplier of integrated systems and products to industries ranging from marine to recreational vehicle and beyond. We offer an unmatched portfolio comprised of industry-leading brands in power management, digital control & monitoring, networked devices and marine electronics.

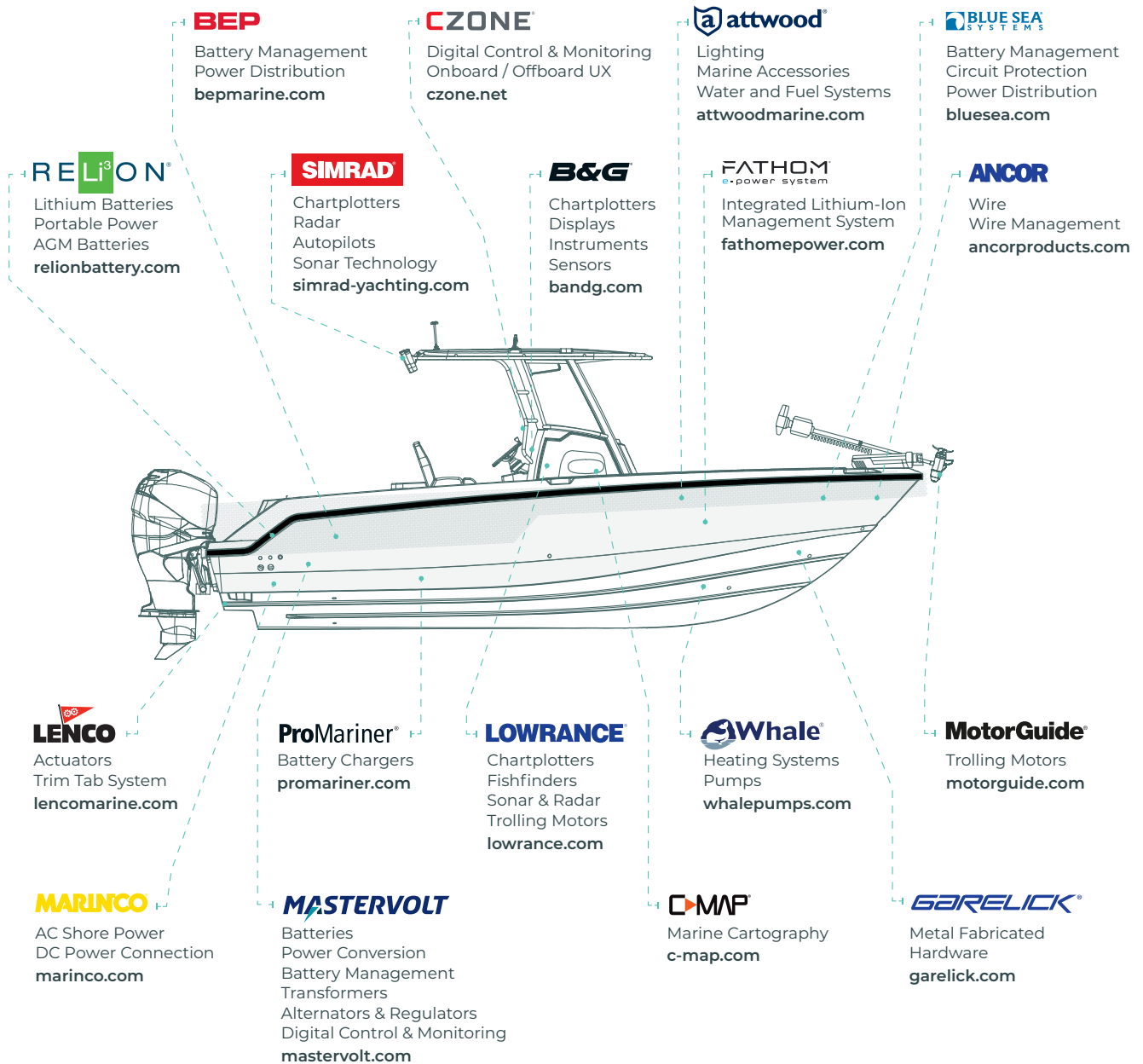

See how far our innovations can take you at Navico.com



What makes BEP different:

| Founder's Vision

BEP offers a range of high quality electrical solutions designed for the harsh Marine and RV environments. Every product meets exacting performance specifications and is designed to withstand extreme conditions, both at sea, and on land.

| Solutions Focused

The BEP team is intimate with the marine environment and develops solutions that improve the installation and use of the products they design. The new products developed reduce assembly time, save space and improve the user experience.

| Innovation & Engineering

BEP's innovative culture and engineering excellence is focused on simplifying the installation and optimizing the user experience with thoroughly tested products that will thrive in the harsh marine environment.

| Worldwide Support

BEP customers have global support in APAC, EMEA and the Americas. The network of support will resolve any issues that come up in supply, technical support and installation questions. BEP is committed to provide the products and support needed to make your installation and experience the best in the industry.

| Trusted Quality

BEP products are designed in New Zealand to withstand prolonged exposure in the harshest environments. Our products have stood the test of time in marine and automotive installations around the world and remain the product of choice by world leading recreational and commercial manufacturers. We stand behind our products and proudly offer a "Trusted Quality" 5-year warranty on all parts.



Table of Contents

Battery Management

Smart Battery Hub	8
Pro Installer Battery Switches	12
Battery Switches	16
Remote Operated Battery Switches	18
Voltage Sensing Relays	20
Battery Distribution Clusters	22
Battery Distribution Panels	27
Battery Management Panels	29



p. 10



p. 14



p. 16



p. 16



p. 18



p. 19



p. 20



p. 21



p. 23



p. 27



p. 28



p. 29

Connectors & Insulators

Pro Installer Bus Bars	32
Pro Installer Fuse Holders	35
Pro Installer Insulated Studs	36
Pro Installer Link Bars	37
Insulated Studs	40
Bus Bars	41
Distribution Studs	42
Circuit Breaker Modules	43



p. 34



p. 35



p. 36



p. 40



p. 38

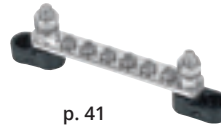

p. 41



p. 41



p. 42



p. 43

Circuit Protection & Switches

Marine Fuses	46
Fuse Holders	47
Circuit Breakers	48
Switches	52

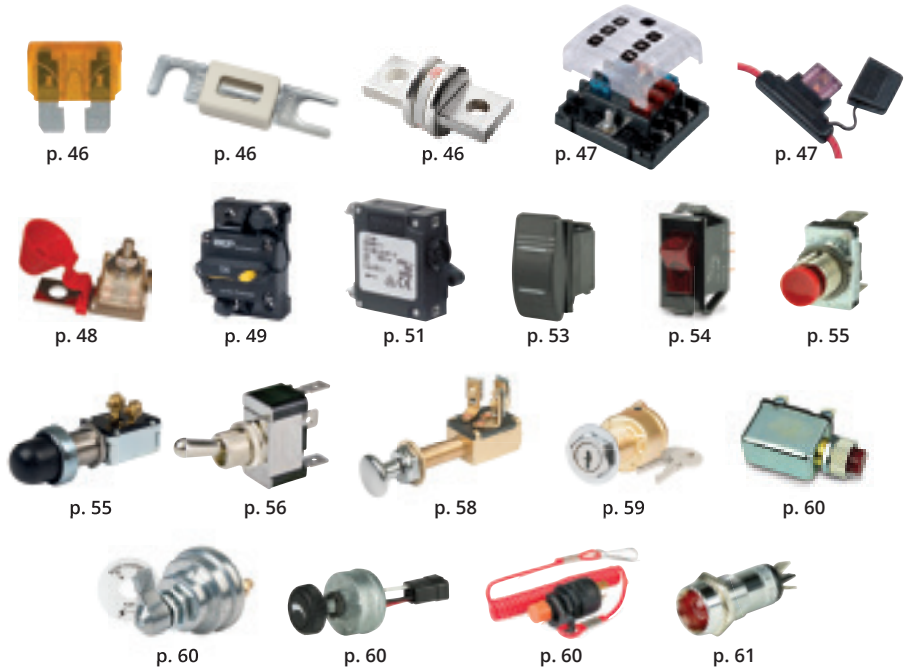

Power Distribution Panels

Switch Panels	64
Push Button Switches	68
Custom Panel & Design Services	69
DC Circuit Breaker Panels	72
AC Circuit Breaker Panels	78
Labels (Panels & Switches)	81

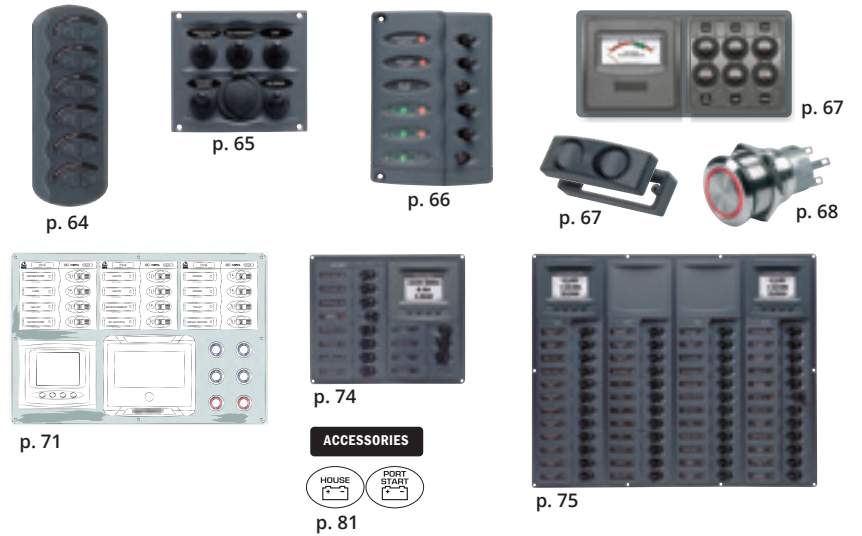

Meters

AC & DC Systems Monitors	88
Tank Senders & Modules	90
Gas Detectors	92
Analog & Digital Meters	94



Appendix & Index

Wire & Cable Technical Data	96
Part Number Index	99

BATTERY MANAGEMENT

Pro Installer Battery Switches



12

The Pro Installer range of premium quality battery switches offer ease and flexibility of installation, and optimal performance in the harsh marine environment.

Battery Switches



16

BEP has pioneered development of battery switches for marine use. Ongoing R&D has further optimized these products to offer a range of high quality but cost effective manual switching solutions.

Remote Operated Battery Switches



18

The MD range of battery switches allow you to install the battery switch very close to the battery, to remotely manage the increased electrical loads found on today's boats. They are ideal for remote isolation of bow and stern thrusters.

Voltage Sensing Switches



20

These switches automatically sense connected battery bank voltages and provide optimal, efficient charging of the second bank. The VSS allows for independent battery banks to be combined or isolated based on the presence of a charging source while also offering remotely activated, high current, emergency parallel connection.



BATTERY MANAGEMENT

Solenoids



19

Remotely switch high amperage loads with a low-amperage on-off switch.

Digital Voltage Sensing Relay (DVSR)



21

The Digital Voltage Sensing Relay (DVSR) provides a highly efficient but inexpensive solution for automatic charging of a second battery bank. It ensures correct charging while removing the risk of flat start batteries.

Battery Distribution Clusters



22

With the successful release of the BEP battery distribution system, BEP saw the need for ready assembled clusters for different applications to make the installation within the battery area even easier.

Battery Distribution Panels

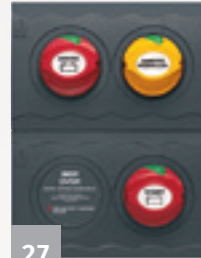

27

The fastest and easiest way to panel mount a battery switch cluster, contour connect panels provide low profile panel mounting plus flexibility in layout.

Battery Management Panels



29

We've integrated our battery switches, circuit protection and secondary charging accessories into one convenient to install panel. In addition to our standard range, we can build custom panels to suit your requirements.





Power Management Redefined

NEW Smart Battery Hub

The BEP Smart Battery Hub is a complete all in one battery management system.

Simplify battery management with remotely activated switches, automatic Voltage Sensitive Switching combined with emergency parallel functionality. Enclosed in a robust easy to install, Ignition Protected IPX7 enclosure.

Monitoring and transmission of battery voltages and full house bank state of charge over NMEA 2000 for integration with multi-function displays.

Options for two to six engine configurations available.

Features & Benefits

- Monitors and transmits all battery voltages, including house bank state of charge via NMEA 2000
- IPX7 and Ignition Protected
- Remotely operated switches via analog inputs or CZone®
- Ultra low power consumption
- Full mechanical override of all switches for safety and servicing

80-716-0030-00	Smart Battery Hub Twin Engine
80-716-0031-00	Smart Battery Hub Triple Engine
80-716-0032-00	Smart Battery Hub Temp Sensor (15m)

WORKS WITH
CZONE®

Integrates with
FATHOM™
e-power system



5 YEAR
WARRANTY



Additional Features

- Remotely operated emergency parallel switches
- Bi-directional voltage sensitive switching with configurable cut in and out voltage thresholds
- Monitor up to 2 tank levels, additional battery voltage, temperature or pressure using industry standard sensors
- Status LED's for all switch outputs and fault indication
- Equipped with advanced core CZone® feature set like load shedding, NMEA 2000 switch bank support and many more
- Support for CZone® logic blocks and data switching
- USB port allows firmware upgrades and full CZone® system updates including configuration changes over the NMEA 2000 network (no PC or adapters required)
- 2 x 10A fused 24 hr house outputs with State of Charge monitoring
- Stand-alone functionality for systems without CZone®



Specifications

Weight	18.5lb (8.4kg)
Power consumption max	92mA
Power consumption sleep	<5mA
NMEA 2000 connectivity	1 x NMEA 2000 Micro-C port, 1 LEN
Warranty period	5 years
Operating temperature range	-5°F to +131°F (-15°C to +55°C)
Storage temperature range	-40°F to +185°F (-40°C to +85°C)
Dimensions W x H x D	14.310" x 10.841" x 6.280" (363.5 x 275.4 x 159.5 mm)
NMEA 2000 PGN Output	Fluid Level, Pressure, Temperature, Battery Volts, State of Charge
Monitoring	Battery voltage, House current draw, House state of charge
Ingress protection	IPX7
Compliance	CE, NMEA, ISO8846/SAE1171 Ignition Protected
Nominal Voltage	12V or 24V, power harvested from all batteries
Continuous rating:	300A
Intermittent rating:	700A
Cranking rating:	1450A
Additional Inputs	3 x Master switch inputs 2 x Analogue Inputs: Positive or Negative Switching, 0-30 Volt, 0-1000 Ohm Resistance and 4-20mA Current 1 x Battery temperature sensor

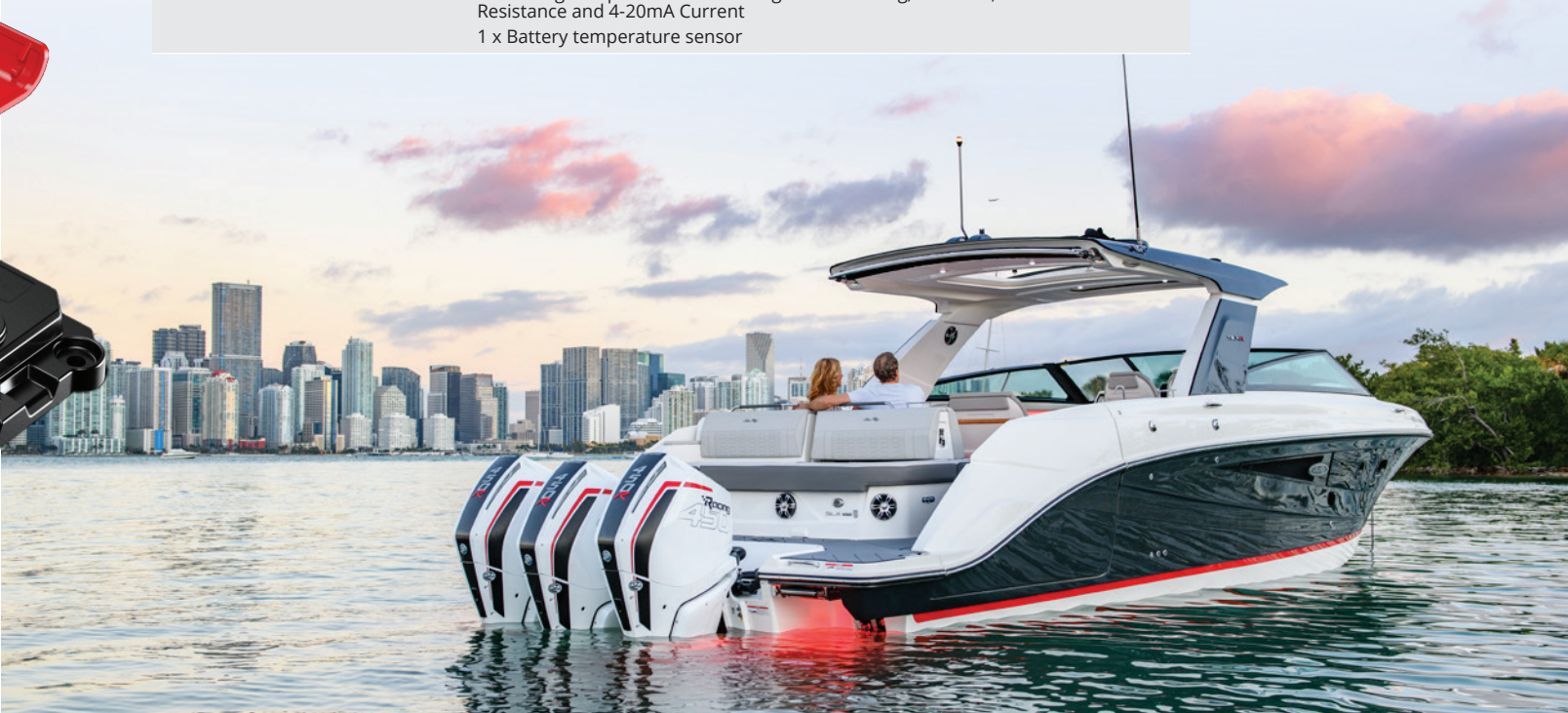

Dimensions

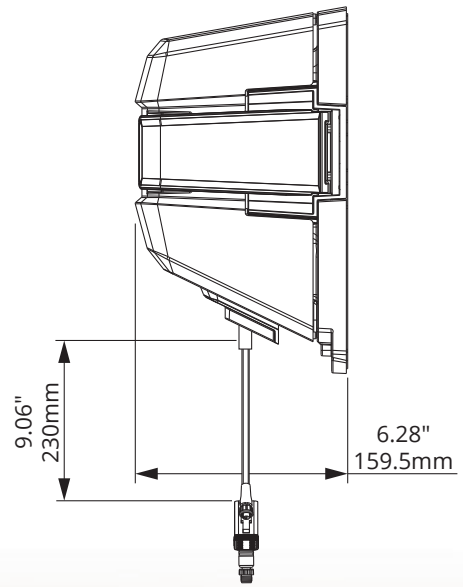
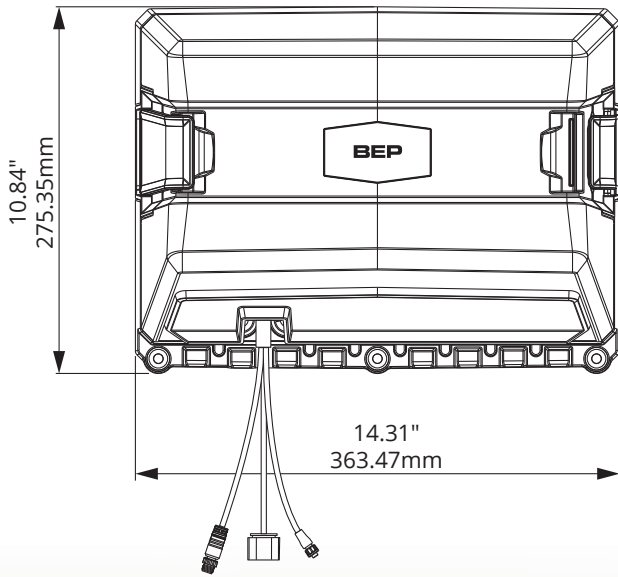

System Example

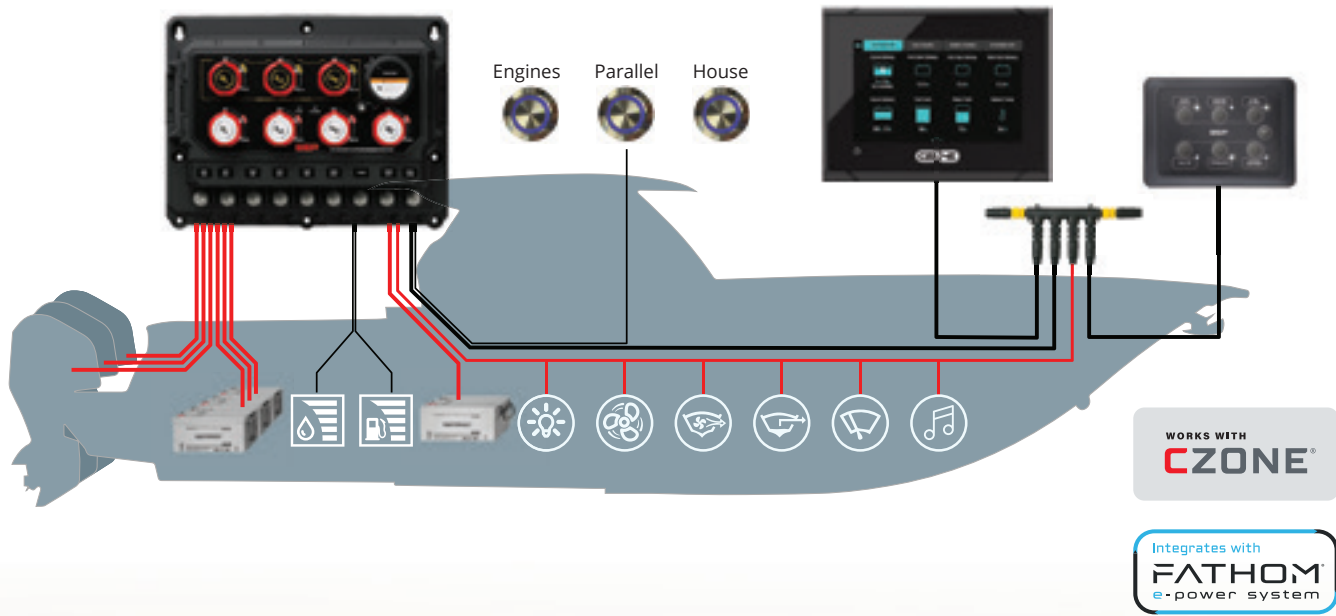

Learn more at fathomepower.com





Pro Installer Battery Switches

The Pro Installer range of premium quality battery switches offer installation in three easy steps and optimal performance in the harsh marine environment. These revolutionary, patented battery switches allow you to wire them from the front.

With models that offer on/off, selector and dual bank control functionalities, the switches feature improved contactor design, ergonomics that provide clear intuitive operation, an industry standard mounting footprint and all switches meet global industry standards. The innovative dual bank control switch offers the functionality of three switches in one. The patented EZ-Mount switches have a compact, industry standard footprint, the ability to cluster with other Pro Installer products, saving valuable onboard space, and are rated 400A continuous, 600A intermittent.

Attention to all aspects of switch function and use has created superior installation options, high power capacity and improved reliability.

All Pro Installer Switches:

- Meets global industry standards CE and ABYC
- Ignition protected
- IP66 rated (*see inside back cover*)
- Removable side plates
- Ergonomic removable switch knobs

See page 32 for more Pro Installer products to complete your cluster.



Pro Installer Standard Mount Switches

This powerful generation of battery switches have a 400A rating with outstanding performance and features for both the installer and end user. Three mounting options: surface, rear panel and front panel mounting, plus optimized cable access makes installation a breeze. Pro Installer switches set the new benchmark with outstanding ergonomics, intuitive look/feel, and are engineered from the finest materials to withstand the harsh marine environment.

- Switch studs face back of switch (when viewed from front)
- Panel mounting allows direct access to the switch studs from rear of panel
- Does not share Pro Installer interconnection height due to different mount options
- Accepts metric or imperial fasteners with innovative nut retention



Standard Mounting Options



Surface Mount

Front Panel Mount

Rear Panel Mount

optional

Check out our Award Winning Pro Installer EZ-Mount Switches

- 1 Fit base
- 2 Add wiring
- 3 Clip on actuator

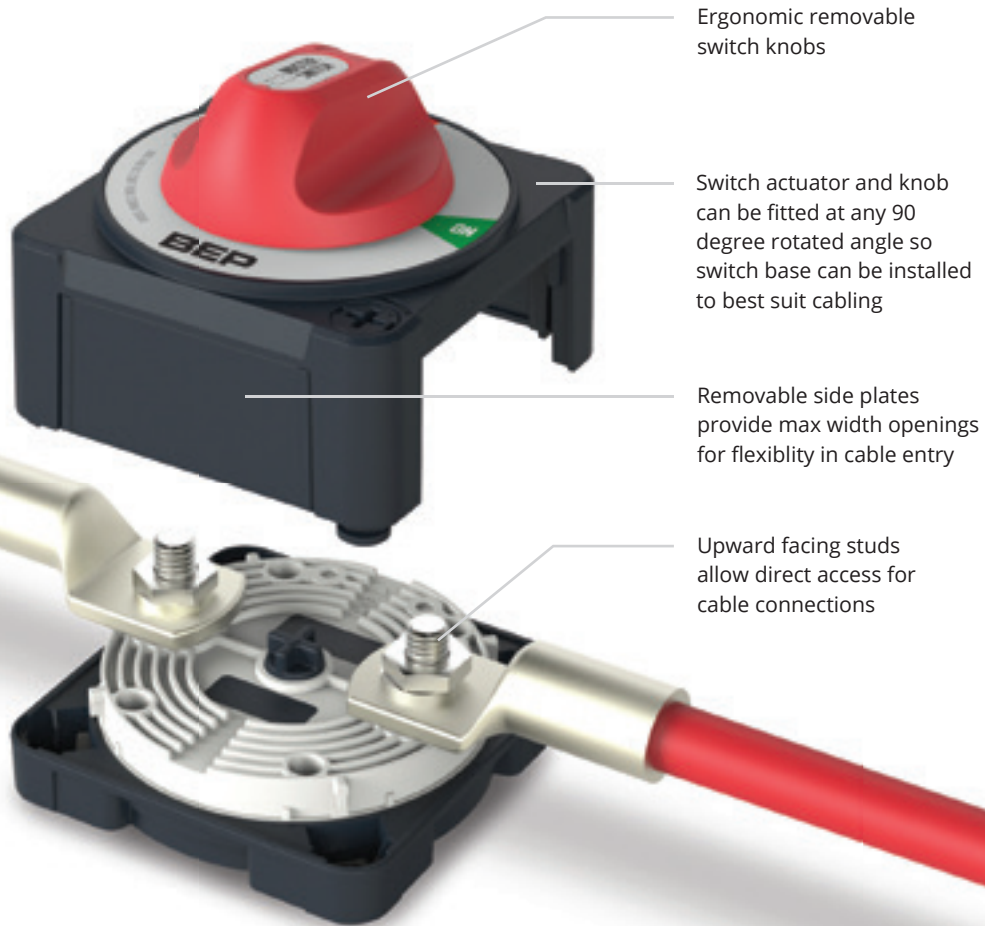

Pro Installer EZ-Mount Switches

Why Pro Installer EZ-Mount?

As easy as 1, 2, 3, these revolutionary, patented battery switches from BEP allow you to wire from the front. Simply remove the back, wire, and then clip the actuator and cover in place. Never has installation been so easy. These durable switches accept large cables or multiple lugs and feature intuitive, ergonomic switch positioning and clear graphics. The EZ-Mount switches have a compact, industry standard footprint, the ability to cluster with other Pro Installer products saving valuable onboard space, and are rated 400A continuous, 600A intermittent. Constructed for longevity in the marine environment, they meet rigorous global standards.



Surface Mount Only



Miami Boatshow



IBEX

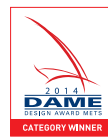

Multi award winning including the prestigious METS DAME award.

Pro Installer Battery Switches

On/Off Battery Switches

For isolation of a single positive supply e.g. as a main House or Start battery switch

Double Pole On/Off Battery Switches

Used where positive and negative supplies must be isolated at the same time.

Selectors (771-S-EZ & 771-S) & Selector with Field Disconnect (771-SFD) Battery Switches

Power requirements on boats have increased, and these Selector switches offer high power capacity (400A continuous), the ability to easily fit doubled cables, and conform to the industry standard mounting footprint (Guest, Perko, Blue Sea Systems).

Please note selector switches will not separate electronics from harmful engine starting spikes.

Related Products



Label Sets page 84



770-DP-EZ



771-S

	On/Off Switch		Double Pole Switch		Selector Switch		Selector w/ Field Disconnect
	EZ-Mount	Standard	EZ-Mount	Standard	EZ-Mount	Standard	Standard
Part #	770-EZ	770*	770-DP-EZ	770-DP	771-S-EZ	771-S	771-SFD
OEM #	770-EZ-B	770-B	770-DP-EZ-B	770-DP-B	771-S-EZ-B	771-S-B	—
Mounting	Surface ONLY	Surface, Rear or Front	Surface ONLY	Surface, Rear or Front	Surface ONLY	Surface, Rear or Front	Surface, Rear or Front
Voltage	48V DC (for 12–48V systems)				48V DC (for 12–48V systems)		
Rating‡	400A Cont / 600A Inter / 1500A Crank				400A Cont / 600A Inter / 1500A Crank		
Dims	3.85" x 3.85" x 3.62" (98 x 98 x 92 mm)				3.85" x 3.85" x 3.62" (98 x 98 x 92 mm)		
Operation	On/Off				1-2-Both-Off		
Stud	2x 10 mm (3/8")		4x 10 mm (3/8")		3x 10 mm (3/8")		

*Emergency Parallel option Part # 770-KEY-EP.

‡120mm² or 4/0 cable required to meet rating.

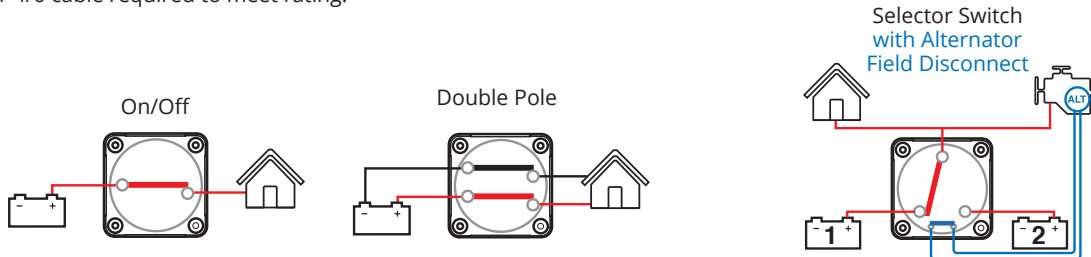

SAFETY NOTE 770-DP & 770-DP-EZ: These switches are not recommended for switching house and start battery systems at the same time, for safety reasons. You may need to isolate your engine battery in an emergency, but not your house battery which typically powers the communications. For this application please use the new Dual Bank Control Switch (772-DBC or 772-DBC-EZ) or one of our battery switch clusters.

Dual Bank Control Battery Switches

These innovative (patented) switches combine the functions of 3 battery switches into one to intuitively manage 2 battery banks and 2 loads. A unique safety position isolates one load e.g. House "On", Start "Off" in case of engine malfunction, so an emergency radio call can still be made. Significant savings in both space and installation cost can be made, without compromising functionality or safety.



772-DBC-EZ

Dual Bank Control Switch

EZ-Mount	Standard
772-DBC-EZ	772-DBC
772-DBC-EZ-B	772-DBC-B
Surface ONLY	Surface, Rear or Front
48V DC (for 12-48V systems, both banks must be same voltage)	
400A Cont / 600A Inter / 1500A Crank	
3.85" x 3.85" x 3.62" (98 x 98 x 92 mm)	
1, 1/2, Parallel, Off	
4x 10 mm (3/8")	

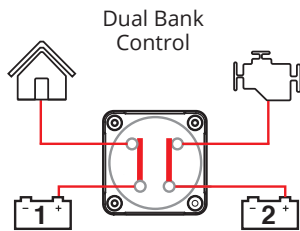

Battery Knob Options for 770 Series

- For applications where emergency parallel switch needs to be highlighted
- Order separately - replaces existing knob

770-KEY-EP



POWER TIP

Dual Bank Control—3 Battery Switches in 1

The Dual Bank Control Battery Switches are an ideal all-in-one solution for a boat or RV with one engine, and two battery banks. This switch combines functionality of 3 switches in 1—House, Start, and Emergency Parallel. The unique, patented safety "1 On" position provides isolation of the Start circuits while leaving the House circuits powered. This allows the user to make an emergency radio call following engine malfunction, or to safely service the engine while House circuits are operational. Intuitive switch operation with ergonomically shaped knob allow for easy operation. Unsurpassed cable access, switch studs placed to allow doubled, back-to-back cable lugs provide for tidy installations.

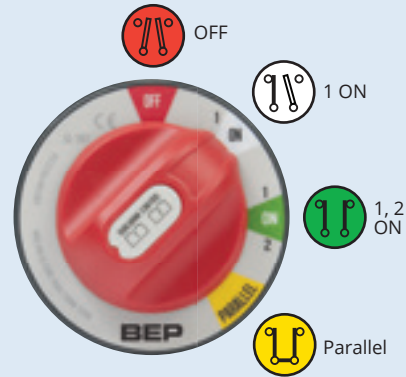

System Example and the Isolated 1-ON Position

In the example below charging is automated by the Digital VSR, so normal control of the system is accomplished by simply turning the Dual Bank Control switch Off/On. Battery banks have been optimized to suit their respective loads, and the load groups are completely isolated during normal operation. The Isolated 1-ON and Emergency Parallel functions are available as additionally required by the user.

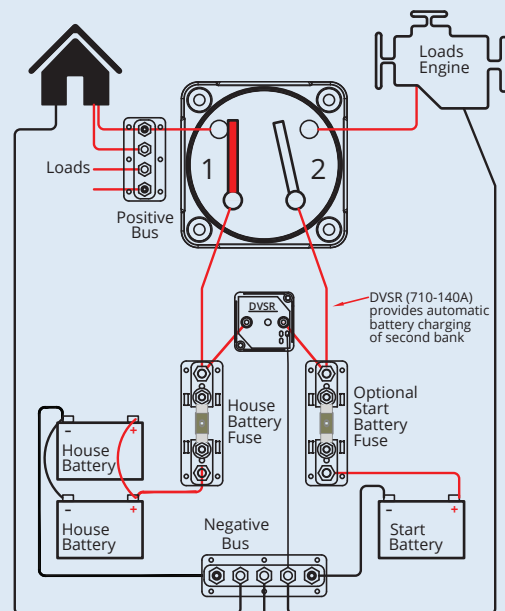

Battery Switches



701



701S



700

Contour Battery Master Switch

- Patented Contour Locking System allows switch to be a stand alone unit, or locked together with other switches.
- Control knob can be removed by switching to counter-clockwise 45° position.
- Three removable side plates for access of up to 1/0 cables plus a rear cover insulating the rear terminals against any short circuits. This ensures the switch meets ABYC requirements.
- 2.1" (52 mm) hole for mounting.

Battery Selector Switch

The 701S is the most compact selector switch available on the market. Housed in the same dimensions as the 701, and includes the same removable side plates and back cover ensuring that it meets ABYC requirements.

- While BEP recommends isolated battery systems as outlined with our distribution clusters, the 701S offers a simple economical way of separating two batteries.

Please note selector switches will not separate electronics from harmful engine starting spikes.

Easyfit™ Battery Switch

Created primarily for installations where switches need to be recessed through varying thicknesses of panels.

- Easily removable threaded ring allows for panel thicknesses up to 3/4" (19 mm).
- Same features as the 701 with the removable knob 45° past the off position.
- Includes removable back cover ensuring that it meets ABYC requirements.
- Surface mount option offers a unique style compared to other switches available on the market.
- Can easily be retro-fitted in place of most European post and lever type switches.



720



721

Heavy-Duty Battery Switch

The 720 is well suited to larger vessels, being capable of handling the high electrical loads found on today's boats and RV's plus starting large diesel engines.

- Rated at 600A continuous and 2500A cranking.
- Can be rear panel, or surface mounted.
- Uses the same proven style of self cleaning sliding copper contact used inside the 701.
- Can be locked with padlock for safely isolating circuits.

Heavy-Duty Battery Selector Switch

The 721 is our heavy-duty selector switch. Housed in the same module as the 720, it includes the same removable plates and back cover.

Please note selector switches will not separate electronics from harmful engine starting spikes.

POWER TIP

BEP Battery Switch Construction

All BEP battery switches are molded in a high strength, fiber reinforced plastic which provides excellent high temperature performance, and the greatest resistance to chemicals that damage other plastic types.

Related Products



Interchangeable labeling system available (Part # 713 or 715)

Label Sets page 84

Specifications - All recessed or surface mount, tin-plated copper studs & nuts, ignition-protected

Part #	OEM #	LxWxH in	LxWxH mm	Cont.	Inter. (5 min)	Crank. (10 sec)	Voltage	Operation	Studs	Cable to meet rating (AWG/mm ²)
700	700B	2.7" x 2.7" x 4.3"	68 x 68 x 110 mm	275A	455A	1250A	48V DC	On/Off	2x 3/8" (10mm)	3/0 / 95mm ²
701	701B	2.75" x 2.75" x 3"	69 x 69 x 75 mm	275A	455A	1250A	48V DC	On/Off	2x 3/8" (10mm)	3/0 / 95mm ²
701S	701S-B	2.75" x 2.75" x 3"	69 x 69 x 75 mm	200A	300A	1000A	48V DC	1-2-Both-Off	3x 5/16" (8mm)	1/0 / 50mm ²
720	720B	4" x 4" x 3.5"	102 x 102 x 90 mm	600A	800A	2500A	48V DC	On/Off	2x 1/2" (12mm)	2x 3/0 / 2x 95mm ²
720-DP	720-DP/B	4" x 4" x 3.5"	102 x 102 x 90 mm	400A	525A	1500A	48V DC	On/Off/DP	2x 1/2" (12mm)	2x 3/0 / 2x 95mm ²
721	721B	4" x 4" x 3.5"	102 x 102 x 90 mm	350A	500A	1500A	48V DC	1-2-Both-Off	2x 1/2" (12mm)	2x 2/0 / 2x 95mm ²

Panel Mounted Battery Switches

Panel Mounted Switches

Designed specifically for panel mount applications. This range gives a very compact, versatile solution.

- Compact, lightweight
- Removable knob on 701-PM
- Countersunk recesses for surface mount application
- Standard 2-1/16" (52 mm) hole cut out (same as standard gauge hole)
- Inside: captive inserts for 3/16" (4.8 mm) nuts; full access for cables - no restrictions
- Standard interchange label system (page 84)
- 701-PM provides On/Off operation for one battery bank
- 701S-PM offers Selector functionality (1/2/1&2) to select between two battery banks



Mounting Plates

Single recessed. Supplied with all the mounting hardware and come in a matching grey finish.

For	Part #	LxW	LxW
701	BSP-1	3.75" x 3.75"	95 x 95 mm

Specifications

Part #	OEM #	LxWxH in	LxWxH mm	Cont.	Inter. (5 min)	Crank. (10 sec)	Voltage	Operation	Stud size Studs x (in/mm)	Cable to meet rating (AWG/mm ²)
701-PM	701B-PM	2.75" x 2.75" x 3"	69 x 69 x 67 mm	275A	455A	1250A	48V DC	On/Off	2x 3/8" / 10mm	3/0 / 95mm ²
701S-PM	701S-B-PM	2.75" x 2.75" x 3"	69 x 69 x 67 mm	200A	300A	1000A	48V DC	1-2-Both-Off	3x 5/16" / 8mm	1/0 / 50mm ²

Related Products



Label Sets
page 84

Battery Knob Options for 701 Series

- For applications where emergency parallel switch needs to be highlighted
- Order separately - replaces existing knob



701-KEY-EP



701-KEY

As shown in Contour Connect panels

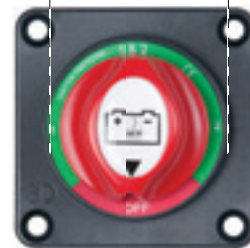

701S-PM



701-PM



Remote Operated Battery Switches

The motor driven range of battery switches allow you to install the battery switch very close to the battery, allowing remote operation to manage the increased electrical loads found on today's boats. This reduces cable lengths and sizes, providing significant savings in expense and weight of copper battery cable. They are ideal for remote isolation of bow and stern thrusters. The 720-MDO has been enhanced to offer easy standard installation, or advanced options capable of switching different voltage circuits from the main supply.

- Motor driven by remote operation
- Battery switch can be mounted alongside battery, reducing cable lengths and cable sizes (large cost and weight saving in copper cables)
- Reduced installation labor, due to shorter battery cable runs
- Manual override option to meet CE/ABYC requirements
- Power draw with switch off for 701-MD @ 15mA and 701-MDCZ @ 12mA
- LED status identification for remote control switch
- Can be either surface, or rear panel mounted
- Uses interchangeable labelling system (Part # 713 or 715 on page 84)

Optical sensor benefits (720-MDO only)

- Same easy connection for standard installation
- Ability to control different voltage circuits
- Can be used to switch positive or negative lines
- Main contacts can be isolated from control circuit allowing operation via another battery source
- Low stand by current draw (<5mA)



701-MD & 701-MDCZ



720-MDO

Specifications - All recessed or surface mount, tin-plated copper studs & nuts, ignition-protected UL1107

Part #	LxWxH in	LxWxH mm	Cont.	Inter. (5 min)	Crank. (10 min)	Voltage	Function	Studs	Cable to meet rating
701-MD	2.7" x 2.7" x 4"	69 x 69 x 101 mm	275A	455A	1250A	9.5-32V DC	On/Off	2x 3/8" (10 mm)	3/0 AWG (95mm ²)
701-MD-D	(Deutsch Plug) Same dimensions and ratings as above								
720-MDO	4" x 4" x 4.33"	102 x 102 x 110 mm	500A	700A	2500A	9.5-32V DC	On/Off	2x 1/2" (12 mm)	3/0 AWG (95mm ²)

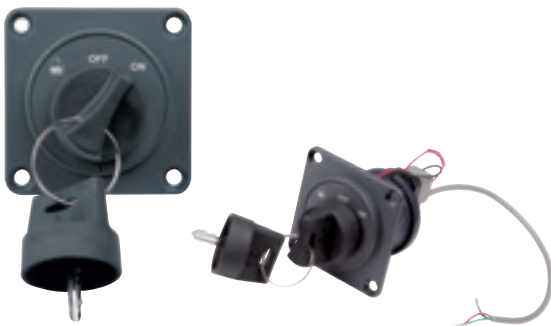

Remote On/Off Key Switch

For the remote operation of the 701-MD and 720-MDO battery switches (page 18).

Can be mounted standalone or within the Contour Connect panel range.

Part # 80-724-0006-00



Terminal Link Kits (TLK's)

Now available for the 701 and 720 size battery switches, the TLK's allow for cable connections to be made outside of the body of the switches.

Part # 80-708-0017-00 701-MD

Part # 80-708-0013-00 720-MDO



Wireless Remote Control

You can now wirelessly operate your BEP motorized battery switches from a distance of up to 250 ft (80 m) away.

- Control up to four separate 5A circuits; eg, 701-MD/720-MDO battery switches, anchor light, navigation lights, and courtesy lights
- No more lifting hatches to turn on battery switches — it's now all controlled from the remote key fob
- Control battery switches easily (On/Off) from the dock
- Remote has a rolling code, for security
- Requires 12V supply for operation, relay channels are fully isolated and are rated 0–32V, 5A
- Activation of the four circuits may be either latching (all four the same), or momentary

Part # 80-911-0045-00



701-KEY-EP



701-KEY

Battery Knob Options for 701 Series

For applications where emergency parallel switch needs to be highlighted.

Order separately - replaces existing knob.

Solenoids

- Remotely switch high amperage loads with a low amperage on-off switch
- Rated from 65A up to 100A for use in 12V DC systems
- Available with steel and PVC coated housings

Part #	Family	Nominal Voltage	Ratings	Termination Type	Amperage
1002203	Remote Switching	12V DC	65A at 12V DC	10-32 thread and 5/16-24 thread	65A
1002205	PVC Coated	12V DC	85A at 12V DC	10-32 thread and 5/16-24 thread	85A
1002204	Remote Switching	12V DC	85A at 12V DC	10-32 thread and 5/16-24 thread	85A
1002206	Engine Starting	12V DC	100A at 12V DC	5/16-24 thread	100A
1002201	Motor Reversing	12V DC	75A at 12V DC	5/16-24 thread & 1/4 blade	75A
1002202	Solid State	9-31V DC	85A at 12V DC	5/16-18 thread & wire leads, 16 AWG, 8"	85A

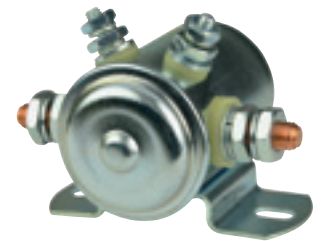

Dual Operation VSS (Voltage Sensitive Switch) and Emergency Parallel

These Voltage Sensitive Switches automatically sense connected battery bank voltages and provide optimal, efficient charging of the second bank. The VSS allows for independent battery banks to be combined or isolated based on the presence of a charging source (such as an engine alternator or battery charger), while also offering remotely activated, high current, emergency parallel connection. Designed and constructed for longevity in the marine environment with tinned copper conductors, stainless steel nuts, and high temperature, fiber reinforced plastics. The units are ignition protected, provide On/Off switching operation, and may be recessed or surface mounted.

- Dual battery sensing
- Remote emergency parallel function: can be operated through a momentary button on the dash which will parallel the batteries for 10 minutes. Once this 10 minutes has passed, if the voltage is up high enough, the voltage sensitive switch will stay engaged. If not, it will disengage. If not, it will disengage.
- Manual override option

720-MDVSO benefits

- Dual 12V/24V operation (both banks must be same voltage)
- Low power consumption (<6mA)
- Lowered cut in voltage (13.3V/26.6V) suits low output alternators and high temperature environments

80-701-0018-00, and 720-MDO-EP: Emergency Parallel Only

- 10 minute remotely activated emergency parallel function (no voltage sensitive function)
- 12V/24V operation (both banks must be same voltage)



80-701-0018-00



720-MDO-EP

Part #	LxWxH in	LxWxH mm	Voltage	Rating	Engages	Disengages	Cable to meet rating
701-MDVS	2.7" x 2.7" x 4"	69 x 69 x 101 mm	12V	275A	13.7V DC	12.2-13.00V DC	3/0AWG (95mm ²)
720-MDVSO	4" x 4" x 4.3"	102 x 102 x 110 mm	12/24V	500A	13.3/26.6V DC	12.7/25.4V DC	2x 3/0AWG (95mm ²)
701-MDVS-24V	2.7" x 2.7" x 4"	69 x 69 x 101 mm	24V	275A	27.4V DC	24.4-26.00V DC	3/0AWG (95mm ²)
80-701-0018-00	2.7" x 2.7" x 4"	69 x 69 x 101 mm	12/24V	275A	Emergency Parallel Only		3/0AWG (95mm ²)
720-MDO-EP	4" x 4" x 4.3"	102 x 102 x 110 mm	12/24V	500A	Emergency Parallel Only		2x 3/0AWG (95mm ²)

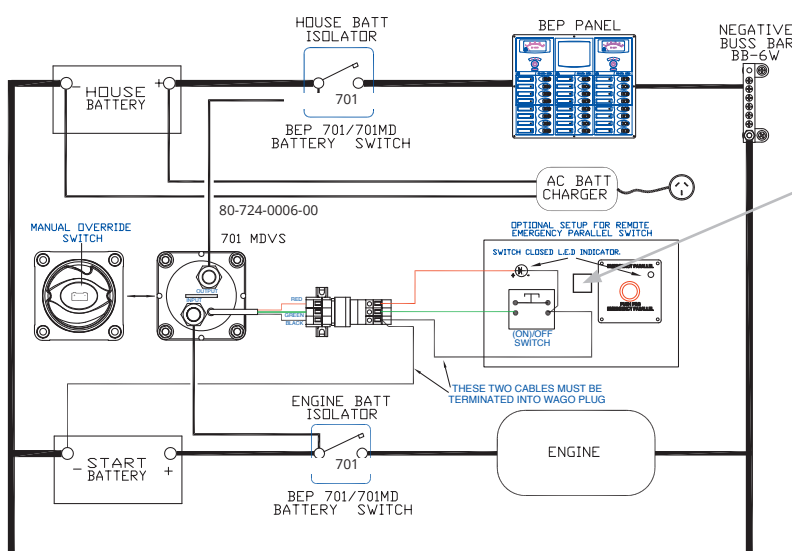

Remote Emergency Parallel Switch

Used for convenient remote activation of the 10 minute emergency parallel function on these motorized Voltage Sensitive and Emergency Parallel switches. It can be mounted standalone or within the Contour Connect panel range.

Part # 80-724-0007-00

DVSR: Dual Battery Charging Made Easy

The Digital Voltage Sensing Relay (DVSR) provides a highly efficient but inexpensive solution for automatic charging of a second battery bank. It ensures correct charging while removing the risk of flat start batteries. When the voltage on the first bank rises sufficiently, the DVSR engages allowing the second battery bank to charge. When charging stops and voltage falls, the DVSR automatically isolates the battery banks, ensuring that engine start batteries are kept fully charged. Digital circuitry provides superior reliability and extremely low power consumption.

- Safely charge two or more independent battery banks from one charge source (alternator, battery charger...)
- Charges engine starting batteries before combining auxiliary bank for charging
- Protects start batteries from becoming flattened by domestic loads
- Isolates electronics from harmful electrical surges from starter motors
- Simple to install 3-wire connection, leaves alternator wiring intact
- No volt drop vs. diode isolators
- Ignition protected
- Surface or panel mountable

Digital Technology Provides:

- Multi voltage, auto selects between 12V and 24V DC operation
- Digital circuits provide very low power consumption (<2mA in standby, up to 8x more efficient than analog models) and enhanced performance
- Remote sensing circuitry allows optional connection from ignition switch, provides same functionality as single sense VSR and zero power consumption when engine is off
- Zero stand by current draw when remote sensing circuit utilized with storage mode switch fitted (switch in open position)
- Remote status LED output option



Part #	OEM #	LxWxH in	LxWxH mm	Voltage	Rating Continuous	Rating Intermittent	Engages	Disengages	Cable to meet rating
710-140A	710-140A-B	2.75" x 2.75" x 2"	69 x 69 x 50 mm	12/24V	125A	140A	13.4/26.8V DC	12.8/25.6V DC	8AWG (8mm ²)

DVSR Operation (shown for 12V system)

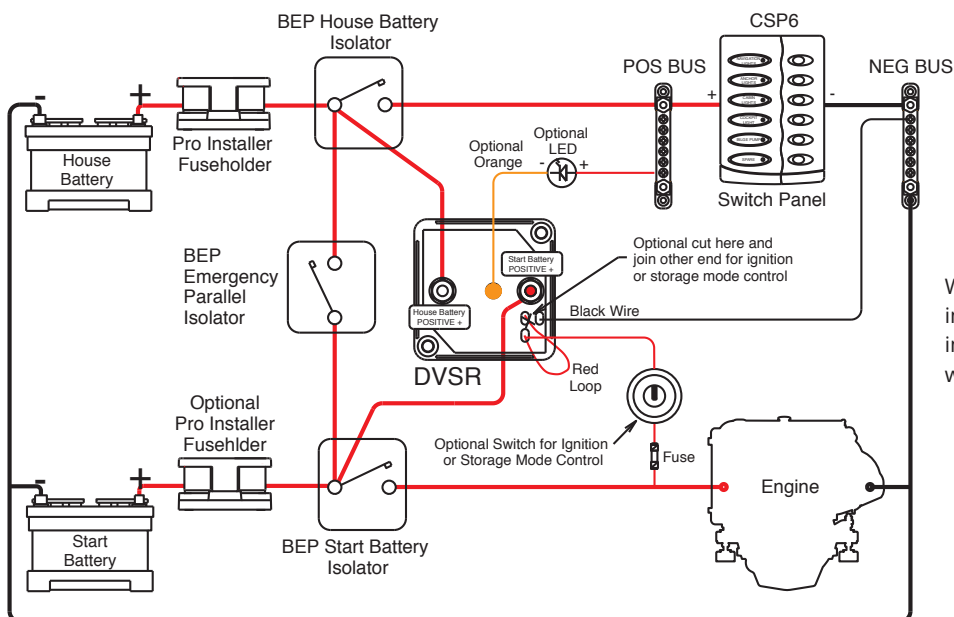
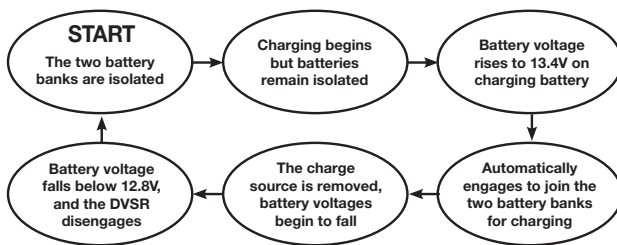

Wiring diagrams indicative of installation only, for full instructions see the BEP website: bepmarine.com

Battery Distribution Clusters

With the successful release of the BEP battery distribution system, BEP saw the need for ready assembled clusters for different applications to make the installation within the battery area even easier. Following is the range as outlined in each diagram, which are overviews only.

All clusters are completely bused and pre-wired internally for easy installation. These include all connecting points clearly marked with ABC labels as shown in all illustrations.



See page 27
for panel versions

Single Engine, Two Battery Banks

The 714-140A-DVSR uses a dual sensing DVSR (710-140A). This system ensures you will always have a fully charged reserve battery. When the switch is in position one, it becomes the sensing battery for the DVSR. Battery two, which is in isolation, will be charged via the DVSR when the engine is running, ensuring it is always fully charged. When the switch is in battery two position, this becomes the sensing battery and battery one is charged via the VSR. The fact that there is always a fully charged battery in reserve is a huge safety factor.

Please note: With the 714-140A-DVSR the electronic loads are run off the same battery as the engine starting battery.

Part # 714-140A-DVSR
OEM # 714-140A-DVSR-B

See table on page 24 for specifications

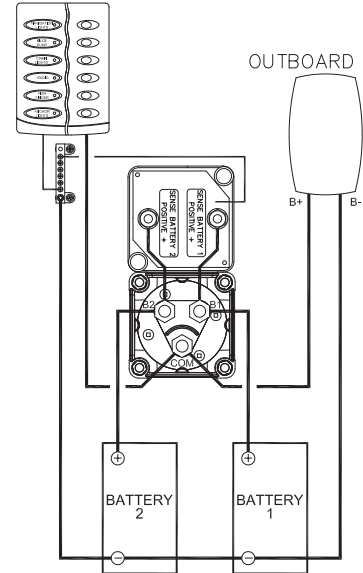

Single Engine, Two Dedicated Battery Banks

Available as horizontal or vertical units. To be used in the following systems:

- 1) Single outboard dual battery bank
- 2) Single alternator dual battery bank
- 3) Twin alternator dual battery bank

Part # 715-H horizontal
Part # 715-V vertical

See table on page 24 for specifications



715-V



715-H

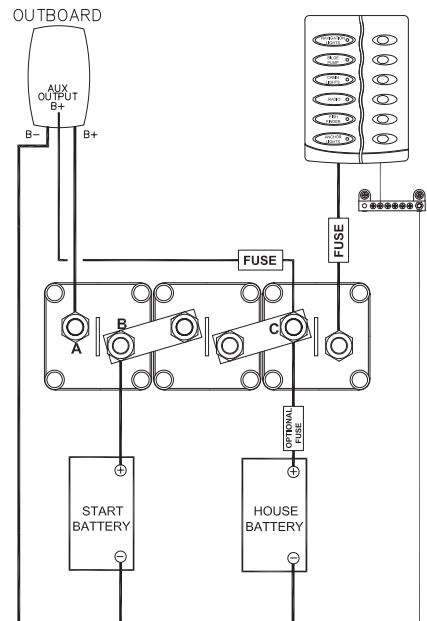

See page 27
for panel versions

Single Engine, Two Battery Banks

An ideal replacement for a Battery Selector Switch. Just remove selector switch and connect existing wires to a 716 cluster, no extra wires are required for a fully automatic battery management system.

No more flat start batteries.

To be used in the following systems:

1. Single outboard dual battery bank.
2. Single alternator inboard engine dual battery bank.

The 716 cluster replaces battery isolator systems.

For DVSR operation, see page 20.

- Part # 716-H-140A-DVSR horizontal
- Part # 716-V-140A-DVSR vertical
- Part # 716-SQ-140A-DVSR square



716-SQ-140A-DVSR



716-H-140A-DVSR

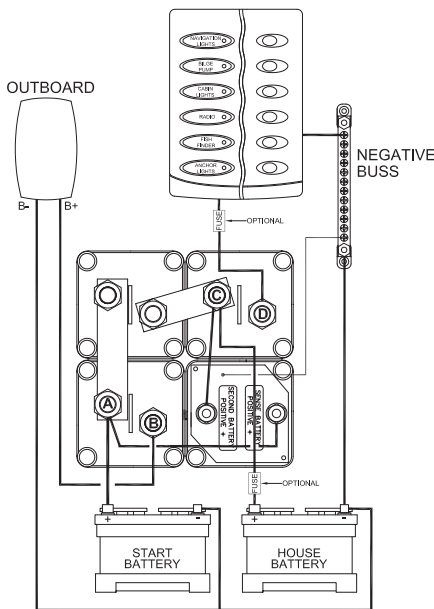

See page 27 for panel versions



Twin Engine, Two Banks

The 715-S allows the house loads to be switched between port and starboard batteries. The selector switch can also be used to parallel the batteries when in both positions.

See table on following page for specifications.

- Part # 715-S



Twin Engine, Three Banks

The 718-140A-DVSR is designed for twin inboard systems when it is not practical to have both engine alternators in parallel because of the types of regulators used on these alternators. The house battery is charged from the port engine when the DVSR is engaged. For DVSR operation read, see page 21.

See table on following page for specifications.

- Part # 718-140A-DVSR



Twin Engine, Three Banks

This system is designed for twin engine installations. It will allow the port engine to charge the port start battery and the house battery when the DVSR is engaged. It will also allow the starboard engine to charge the starboard start battery and the house battery when the starboard DVSR is engaged, giving a combined charge from two engines into the house battery until the voltage regulators on both engines control the charge. It will also allow the house battery to be charged if steaming on one engine.

See table below for specifications.

Part # 717-140A-DVSR



Triple Engine, Four Banks

This system is designed for triple engine installations. Once again using multiple DVSRs off each start battery giving combined charge from all three engines into the house battery via DVSRs.

See table below for specifications.

Part # 719-140A-DVSR



See page 27 for panel versions

Dimension guide

Clusters are made from uniformly square switches, each side 2.7" (69 mm)



Specifications

Engine Type	Battery (banks)	DVSR	Orientation	Part #	LxWxH in	LxWxH mm
Single inboard or outboard	2	yes	vertical	714-140A-DVSR	5.4" x 2.75" x 3"	138 x 69 x 75mm
		yes	horizontal	716-H-140A-DVSR	10.85" x 2.75" x 3"	276 x 69 x 75mm
		yes	vertical	716-V-140A-DVSR	10.9" x 2.7" x 3"	276 x 69 x 75mm
		yes	square	716-SQ-140A-DVSR	5.4" x 5.4" x 3"	138 x 138 x 75mm
		no	horizontal	715-H	8.1" x 2.75" x 3"	207 x 69 x 75mm
		no	vertical	715-V	2.75" x 8.1" x 3"	69 x 207 x 75mm
Twin inboard or outboard	2	no	horizontal	715-S	8.1" x 2.75" x 3"	210 x 69 x 75mm
Twin inboard	3	yes	horizontal	718-140A-DVSR	8.1" x 5.4" x 3"	207 x 138 x 75mm
Twin outboard	3	yes	horizontal	717-140A-DVSR	5.4" x 8.1" x 3"	138 x 207 x 75mm
Triple outboard	4	yes	square	719-140A-DVSR	8.1" x 8.1" x 3"	207 x 207 x 75mm

DVSR Charging Current: 125A continuous Battery Switch Rating: 275A continuous



Single Engine, Two Battery Banks with Motorized VSR

Offers the same features as the 716-SQ-140A-DVSR (page 23), with two important differences. The VSR and Emergency Parallel switches are combined into one voltage-sensitive switch, and that switch is able to be remote-operated. For features of the motorized VSR, see page 21. The layout allows all cables to be attached from the bottom of the cluster.

Part # 80-716-0017-00



Twin Engine, Three Banks with Motorized VSR

Offers the same features as the 717-140A-DVSR (page 24). The VSR and Emergency Parallel switches are combined into one voltage-sensitive switch, and that switch is able to be remote-operated. For features of the motorized VSR, see page 21. The layout allows all cables to be attached from the bottom of the cluster.

Part # 80-716-0018-00

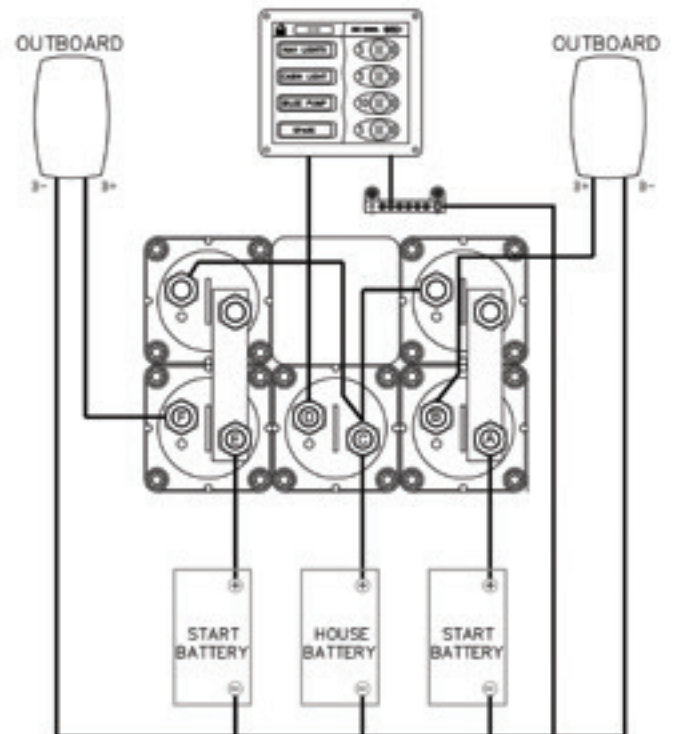
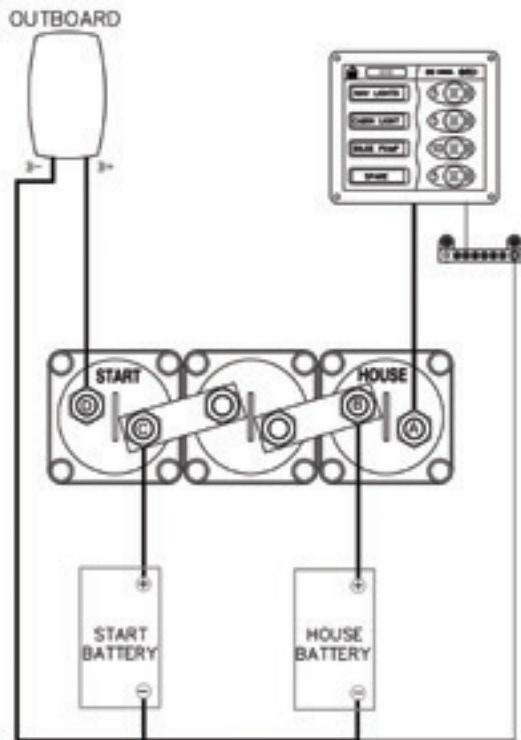

 See page 27 for panel versions

Remote Battery Management Clusters

- Complete system including all cable links (Battery Control Center ordered separately—see below)
- Offers all features of motorized battery switches and Motorized VSRs in one kit. Makes ordering easy!
- Clusters are surface mount, and can be rearranged to meet specific needs, such as port and starboard configurations and can be combined with other battery distribution products
- Available in single, dual and triple engine configurations

Single Engine



80-716-0014-00

Dual Engine



80-716-0015-00

Triple Engine



80-716-0016-00

Battery Control Center

Sophisticated electrical systems need reliable automation. That's key. Centralize power handling with the BEP Battery Control Center.

Cluster or Contour Connect mounted, delivers hard-handling, good-looking power management where it's needed. The Battery Control Center (BCC) is equipped with locks on each battery switch position. This ensures group operation at the turn of the key. Any switch can be isolated by disengaging its lock and toggling the switch off.

Description	Part #
Single engine remote	80-700-0050-00
Twin engine remote	80-700-0051-00
Triple engine remote	80-700-0052-00



80-700-0051-00

Battery Distribution Panels

Fast fit, flush mounting battery distribution panels

1. Use template to mark rectangular hole in fascia
2. Cut hole
3. Fit panel and screw into place
4. Add trim pieces
5. Connect cables



Single Engine, Two Battery Banks

This panel incorporates a version of our very successful 714-140A-DVSR cluster (page 22).

Supplied pre-wired with back cover and CC-J joiner to allow it to be combined with other modules.

Supplied standard in charcoal with grey wave strip. Other trim colors are available for volume OEM orders.

Part # CC-801

Dimensions for Contour Connect Panels

Part #	LxWxH (Module)	Cut-out	LxWxH (Module)	Cut-out
CC-801	6.5" x 4.2" x 2.2"	5.75" x 3.4"	166 x 106 x 55 mm	146 x 86 mm
CC-810	9.2" x 4.2" x 2.2"	8.5" x 3.4"	233 x 106 x 55 mm	213 x 86 mm
CC-802	6.5" x 8.3" x 2.2"	5.75" x 7.5"*	166 x 212 x 55 mm	88 x 148 mm*
CC-803N	9.2" x 8.3" x 2.2"	8.5" x 3.4"*	223 x 212 x 55 mm	213 x 86 mm*

*Single hole only.



Single Engine, Two Battery Banks

The CC-810 is supplied standard with 3 x 701-PM battery switches pre-assembled.

Ideal for installing alongside any other Contour Connect Modules.

Part # CC-810



Single Engine, Two Battery Banks

The CC-802 incorporates a version of our very successful single engine battery switch cluster (page 23).

The CC-802 is supplied loosely assembled with links and joiners to allow it to be assembled in either the vertical or horizontal orientation as shown in illustrations.

Full wiring instructions are supplied to allow pre assembly for both orientations.

Part # CC-802



Twin Engine, Three Battery Banks

The CC-803N incorporates a version of our very successful dual engine battery switch cluster (page 24).

The CC-803N is supplied with cables to allow for horizontal or vertical configurations.

The components can also be easily removed and reconfigured if the factory layout does not suit your application.

Part # CC-803N





The below panels are designed for applications where the OEM or panel builder wishes to construct a custom system. They're supplied as empty panels with all necessary mounting hardware, including one CC-joiner.

CC-1



CC-5



CC-1 & CC-5 Modules

Will house the following components:

- 701-PM Panel mount battery on/off (page 17).
- 701S-PM Panel mount battery selector switch (page 17).
- 185 Series Heavy-duty circuit breakers (page 49). (CC-HDBM must be ordered with 185 series circuit breakers, one per breaker).
- 710-140A Voltage Sensitive Relay (see page 21).



CC-2 Module

Will house the following components:

- CLB series (push reset) Carling circuit breakers (page 50).
- Toggle Magnetic Hydraulic Carling circuit breakers (page 51).



CC-HDBM

BEP CB Panel Mount

The CC-HDBM module must be ordered separately if ordering BEP 184 & 185 series circuit breakers. Mounting hardware for CB and panel attachment is supplied with module.

5-way CB Panel

- 1x Heavy-Duty CB, 1x Toggle, 3x Push Reset
- Equipped to cover essential circuits requirements (bilge, pumps etc)
- 50A CB for DC mains or treatment systems
- 135A 185 Series CB for anchor windlass
- Compliments the other modules for either single or dual engine installations
- 3 x 10A push to reset thermal breakers
- *Custom configurations can be supplied to order*

Part # CC-804



Blanking Plate

The CC-BLANK will cover an unused hole in CC-1 and CC-2. Attached from the rear of the panel, it allows for expanding with other options at a later date.

Part # CC-BLANK



Solid Links

708-42.5 Solid terminal links supplied pre-connected with spare links for different orientations (horizontal or vertical) of Contour Connect panels.

Must be ordered separately when ordering CC Kitset panels.



Part #	Application
708-42.5	For horizontal linking of battery switches in the same panel
708-70.0	For horizontal linking of battery switches studs between two separate panels
708-107-V3	For vertical linking of battery switches between panels

Battery Management Panels

- Essential circuits, 24-hour supply
- Mains breakers for control panels, davit winches, or treatment systems
- Panels are supplied with a BEP 703-300A/B heavy-duty negative bus, to accommodate all the negative connections at the battery (Please note: 800-MS4* is supplied with 702B negative stud)
- Heavy-duty breakers for anchor winches
- Powder coated aluminum panel
- Supplied with a full label set for panel circuit breakers—Part # SET-MSP; additional label sets available (page 83)
- Spare positions for additional battery switches and circuit breakers for extras such as radio batteries and genset batteries
- NOTE: Custom panels made on request

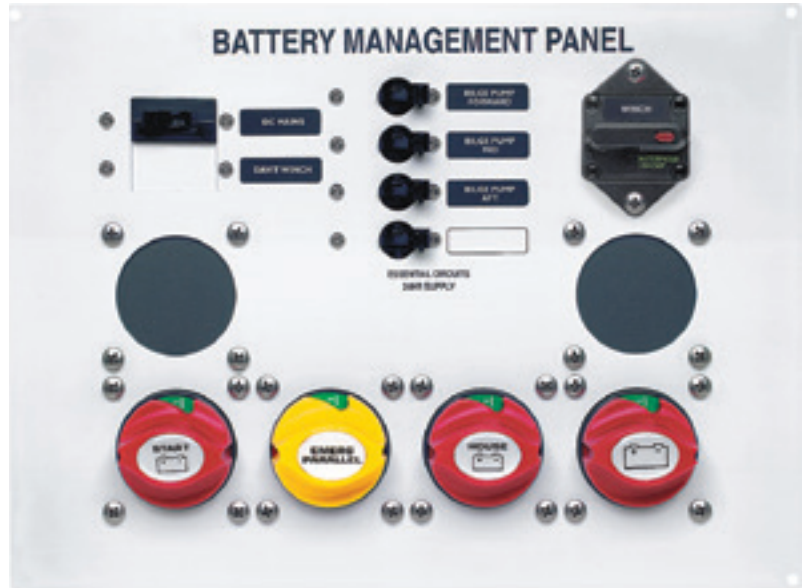

800-MS1

The 800-MS1 panel is designed for power or sail boats between 32.9–39.5 ft (10–12m) with single engines. 10.25" x 13.8" x 2.9" (260 x 351 x 75 mm)

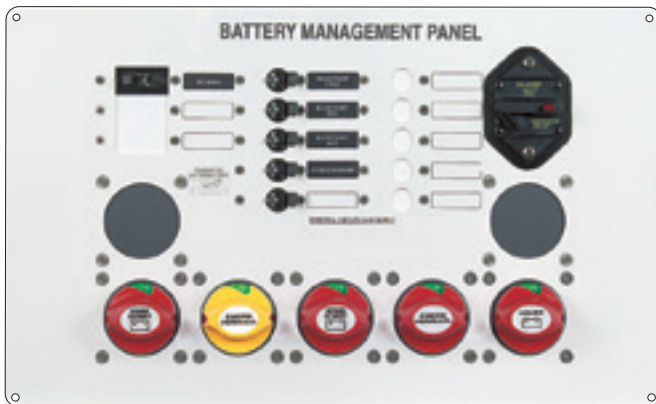

800-MS2

The 800-MS2 panel is designed for power boats between 32.9–39.5 ft (10–12m) with twin engines. 11.1" x 18.25" x 2.9" (281 x 463 x 75 mm)



800-MS3

The 800-MS3 panel is designed for power boats between 39.5 – 52.5 ft (12–16m) with larger diesels. 15" x 18.25" x 3.75" (380 x 463 x 95 mm)



800-MS4

The 800-MS4* panel is designed for sail boats up to 46 ft (14m) and power boats up to 32.9 ft (10m) with single engine. 6.3" x 9.4" x 2.9" (160 x 239 x 75 mm)

Enquire about our custom battery management panels!

*Special Order Only

Auxiliary Parts (ordered separately)

- Part # 701 Battery switches to fit panel cutouts
- Part # 713 Battery switch label sheet

Circuit Breakers

For treatment systems, davit winches and sub-mains.

- Part # CBL-50A-SP 50A
- Part # CBL-75A-SP 75A
- Part # CBL-100A-SP 100AW

CONNECTORS & INSULATORS

Pro Installer Bus Bars



34

Pro Installer Busbars are the ultimate solution for compact termination of small cables.

Pro Installer Fuse Holders



35

Pro Installer fuse holders offer flexibility to cover fusing requirements from 30-750 amps.

Pro Installer Insulated Studs



36

Pro Installer Insulated Studs are available in single and twin stud versions.

Pro Installer Link Bars



38

The Pro Installer range features modular products which can be linked together in order to provide space saving, fast installation clusters. These tinned copper link bars provide the means to join battery switches, bus bars, fuse holders and insulated studs.



CONNECTORS & INSULATORS

Insulated Studs



40

An economical range of connection studs for smaller electrical loads.

Bus Bars

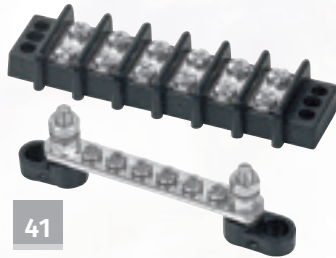

41

Bus bar range for smaller connections and loads under 150A.

Distribution Studs



42

For connections where a robust, mechanically fastened cover is required for protection.

Circuit Breakers



43

Convenient surface mounting circuit breaker modules for main, secondary, or 24-hour circuit protection.



Australia's Riviera Boats specifies BEP products aboard their line of yachts, including the Riviera 545 SUV.

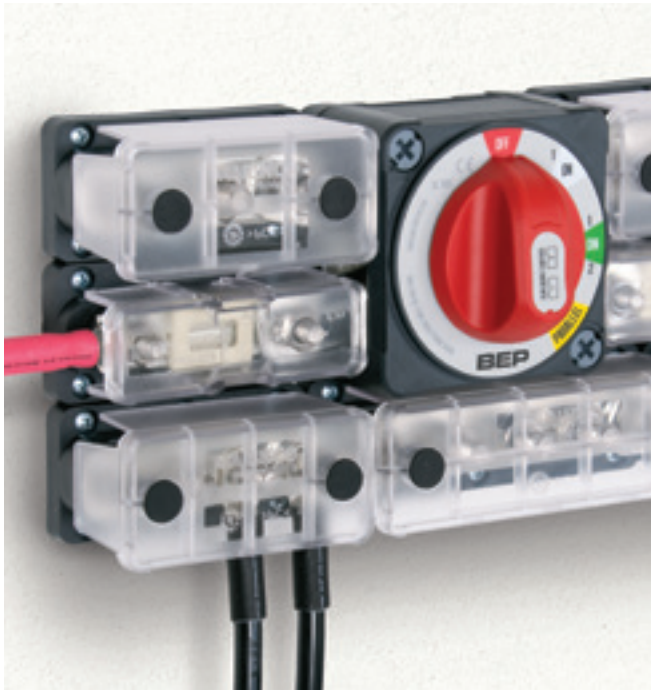

Pro Installer Series

Onboard power demands continue to increase as boaters request the comforts of home on their boats. BEP looked at the common products used by electrical installers every day and made significant improvements to their design and construction. The result is a robust product line with greater capacity and extended product life.

The valuable space saved onboard gives builders or installers greater flexibility when designing power systems. Since Pro Installer modular assemblies are designed for fast, flexible installation in tight spaces, it's easy to "cluster" products and reduce their mounting footprint. The common interconnection height enables solid link bars to connect multiple Pro Installer products — a smart design feature for watercraft. Like all BEP products, you can be assured of durable construction engineered specifically to handle the challenging marine environment. High-temperature, fiber-reinforced base material provides strength and chemical resistance.

All Pro Installer products include a common interconnection height, label recess on the cover, ability to "cluster" and a compact footprint. All studs, washers and nuts are made of stainless steel.

See page 14 for Pro Installer Battery Switches to complete your cluster.

Features and Benefits:

- Common interconnection height makes it easy to 'cluster' products
- Modular assemblies offer unrivalled flexibility in design/layout
- Reduced individual footprints save additional space for the most compact installations
- Robust construction for the harshest of marine environments

Covers feature snap-out side skirts for additional cable entry as required

Stainless steel studs, washers and nuts

Radiused bar ends and generous stud lengths improve cable routing options for large cables

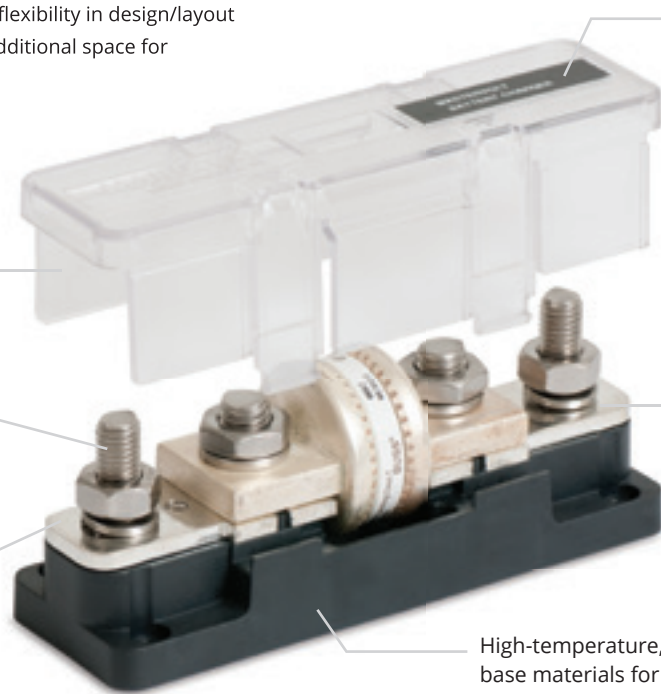

Innovative clear covers insulate/protect on three sides, and include recesses for convenient labeling*

Use any label maker with 1/2" stock to create your label



Tin-plated copper conductors

High-temperature, fiber reinforced base materials for strength and chemical resistance

*Does not come with label fitted

Typical Cluster example

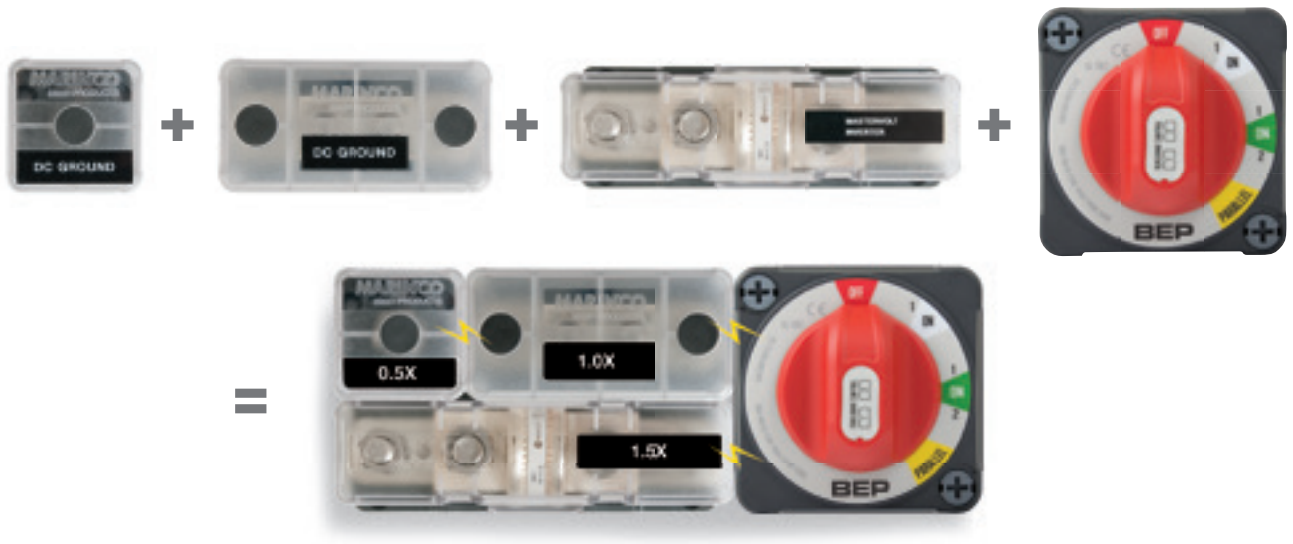

Product Footprints				
	.5x 49mm(1.9") 19mm(.9")	1x 98mm(3.8") 19mm(.9")	1.5x 147mm(5.8") 19mm(.9")	2.5x 249mm(9.8") 19mm(.9")
Heavy-duty Bus Bars				
777-BB4S-500	4 Stud	✓		
777-BB3S-650	3 Stud	✓		
777-BB5S-650	5 Stud		✓	
777-BB8S-650	8 Stud			✓
Z Bus Bars				
777-Z10W-200	10-way	✓		
777-Z18W-200	18-way		✓	
ANL Fuse Holders				
778-ANL	ANL	✓		
778-ANL2S	ANL with additional cable clamping studs		✓	
778-ANLTP	ANL Through Panel	✓		
Class-T Fuse Holders				
778-T2S-400	225-400A		✓	
778-T2S-600	450-600A		✓	
Insulated Studs				
IST-8MM-1S	Single 8 mm	✓		
IST-8MM-2S	Double 8 mm	✓		
IST-10MM-8MM	Double 10 mm / 8 mm	✓		
IST-10MM-1S	Single 10 mm	✓		
IST-10MM-2S	Double 10 mm	✓		
IST-8MM-1SPT	Single 8 mm with power tapping plate	✓		
IST-10MM-1SPT	Single 10 mm with power tapping plate	✓		

Pro Installer Heavy-duty Bus Bars

Pro Installer Heavy-duty Bus Bars provide a robust means to connect (bus) together the multitude of large cables found in modern electrical installations. They offer unrivaled flexibility to meet the requirements of any installation, saving significant cost and space.

Specifications:

- 4 Stud-500A bus bar: 8 mm (5/16") stainless steel studs
- 3, 5, and 8 stud-650A bus bars: 10 mm (3/8") stainless steel studs
- Studs treated with anti-seize lubricant
- 50V DC
- Tinned CDA102 Copper conductors
- Stainless steel studs, washers, nuts for longevity in the marine environment
- Generous stud lengths, metric threads

Description	Part #	OEM #	Footprint*
3 Stud Bus Bar	777-BB3S-650	777-BB3S-650-B	1 x
4 Stud Bus Bar	777-BB4S-500	777-BB4S-500-B	1 x
5 Stud Bus Bar	777-BB5S-650	777-BB5S-650-B	1.5 x
8 Stud Bus Bar	777-BB8S-650	777-BB8S-650-B	2.5 x

* See page 33 for Footprint details



Related Products



Pro Installer Link Bars page 37

Pro Installer Z Bus Bars

BEP products have created a completely new concept for small cable termination with the Z-Bar range. These Bus Bars maximize power density by utilizing high and low level bars to optimize cable runs, saving even more installation space.

Specifications:

- 10-way and 18-way versions
- 4x 6 mm (1/4") studs with anti-seize lubricant
- 4 mm (5/32") terminals with captive lock washers
- 200A maximum per bar (2x 200A)
- 50V DC
- Tinned CDA102 Copper conductors
- Stainless steel studs, washers, nuts for longevity in the marine environment
- Metric threads

Description	Part #	OEM #	Footprint*
10-way, Z Bus Bar	777-Z10W-200	777-Z10W-200-B	1 x
18-way, Z Bus Bar	777-Z18W-200	777-Z18W-200-B	1.5 x

* See page 33 for Footprint details

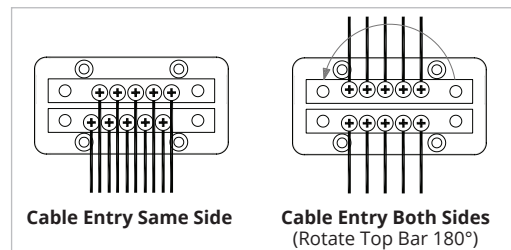

Related Products



Pro Installer Link Bars page 37

Pro Installer ANL Fuse Holders

These ANL fuse holders offer unparalleled circuit protection choice for both the installer and end-user. The innovative Through-Panel fuse holder (778-ANLTP) provides superior access for fuse inspection and replacement. Small electrical loads are catered to with the compact 778-ANL unit while additional cable security and highest capacity is provided by the 778-ANL-2S, featuring additional studs for separate clamping of cables.

Specifications:

- Cable connection studs: 8 mm (5/16") studs on 778-ANL, 10 mm (3/8") studs on 778-ANL-TP and 778-ANL-2S
- Fuse mounting studs: 8 mm (5/16")
- Double washers allow any ANL fuse brand to be fitted
- Fuse type: ANL or ANN (fast blow)
- Swinging fuse style allows changing fuse without removal of fastening nuts
- Amperage: determined by fuse sizing, 778-ANL: 35-300A, 778-ANL2S: 35-750A, 778-ANLTP, 35-500A
- 50V DC
- Tinned CDA102 copper conductors 778-ANL-2S
- Tinned CDA260 high conductivity brass conductors 778-ANLTP

Description	Part #	OEM #	Footprint*
Fuse Holder, ANL	778-ANL	778-ANL-B	1 x
Fuse Holder, ANL with additional cable clamping studs	778-ANL2S	778-ANL2S-B	1.5 x
ANL Through Panel	778-ANLTP	778-ANLTP-B	1 x

* See page 33 for Footprint details



Related Products



Pro Installer Link Bars page 37



ANL Fuses page 46

Pro Installer Class-T Fuse Holders

Class-T fusing provides the ultimate protection for high power circuits, and where extremely fast fuse blow characteristics are required. Modern battery technologies such as Mastervolt Lithium Ion or AGM are capable of very high short circuit currents which may be beyond the interrupt rating of standard circuit breakers and other types of fuse. Two sizes of Pro Installer Class-T Fuse Holder are available which accommodate fuses from 225-400A, and 450-600A respectively.

Specifications:

- Cable connection studs: 10 mm (3/8") studs
- Fuse mounting studs: 10 mm (3/8") 225-400A holder, 12 mm (1/2") 450-600A holder
- Fuse type: Class-T (JLLN / TJN / A3T)
- Maximum amperage: Determined by fuse sizing, either 400A or 600A
- 50V DC
- High temperature, fiber reinforced plastic base provides strength and chemical resistance
- Clear polycarbonate cover
- Tinned CDA102 Copper conductors
- Stainless steel studs, washers and nuts for longevity in the marine environment
- Metric threads

Description	Part #	OEM #	Footprint*
Fuse Holder, Class-T 225-400A	778-T2S-400	778-T2S-400-B	1.5 x
Fuse Holder, Class-T 450-600A	778-T2S-600	778-T2S-600-B	1.5 x

* See page 33 for Footprint details



Related Products



Pro Installer Link Bars page 37



Class T Fuses page 46

Pro Installer Insulated Studs

Pro Installer Insulated studs are available in single and twin stud versions, featuring 8 mm (5/16") and 10 mm (3/8") variants. A double stud version with 10 mm and 8 mm studs is also included for extending outboard motor cables. The Power Tapping Plate single stud models provide convenient termination points for additional small cables. Pro Installer family features are replicated with these insulated studs, generous stud length, modular footprint, insulating covers with label recess, and common interconnection height.

Specifications:

- Power tapping plate: 4x 4 mm (5/16") terminals
- Maximum current through power tapping plate: 50A per terminal (4x 50A maximum)
- Note: no power passes through the stud so no amp rating is given 50V DC
- High temperature, fiber reinforced plastic base provides strength and chemical resistance
- Clear polycarbonate cover with snap-out extra cable access
- Stainless steel studs, screws and nuts for longevity in the marine environment
- Insert moulded studs with metric threads
- Double studs feature 'snap out' insulating partition, to allow linking of studs

Description	Part #	OEM #	Footprint*
Single 8 mm	IST-8MM-1S	IST-8MM-1S-B	0.5 x
Double 8 mm	IST-8MM-2S	IST-8MM-2S-B	0.5 x
Double 10 mm / 8 mm	IST-10MM-8MM	IST-10MM-8MM-B	0.5 x
Single 10 mm	IST-10MM-1S	IST-10MM-1S-B	0.5 x
Double 10 mm	IST-10MM-2S	IST-10MM-2S-B	0.5 x
Single 8 mm with power Tapping Plate	IST-8MM-1SPT	IST-8MM-1SPT-B	0.5 x
Single 10 mm with power Tapping Plate	IST-10MM-1SPT	IST-10MM-1SPT-B	0.5 x

* See page 33 for Footprint details

Related Products



Pro Installer
Link Bars
page 37



IST-8MM-1S



IST-8MM-2S



IST-10MM-8MM



IST-10MM-1S



IST-10MM-2S



IST-8MM-1SPT



IST-10MM-1SPT

Pro Installer Link Bars

- A range of linking bars to complement the Pro Installer range of products
- High purity copper, tin plated for optimum marine electrical performance
- Fastest, most economic way of connecting products
- Saves space, allows clustering for the most compact installations
- Links can be doubled for higher loads



Choosing a Link Bar

Step 1: Use selection guide below to determine the correct link bar.

Step 2: If multiple options exist, see diagrams for layout options on page 39.

Step 3: Find the part number in the specifications table on page 38.

Linking Selection Guide

	3, 4, 5, & 8 Stud Heavy Duty Bus Bars	10 & 18 Way Z Bus Bars	778-ANL Fuse Holder	ANL Through Panel Fuse Holder	ANL & Class T Double Stud Fuse Holders	Single Insulated Studs	Double Insulated Studs	EZ Mount Battery Switch On/Off
Bus Bars								
3, 4, 5, & 8 Stud Heavy Duty Bus Bars	LB-1	LBZ-2	LB-1	—	LB-1 (4 Stud Gap)	LB-2	S:E LB-1 Gap LB-1	O: LB-2 C: LB-1
10 & 18 Way Z Bus Bars	LBZ-2	LBZ-1	LBZ-2	—	LBZ-2	—	Gap LBZ-2	LBZ-2
Fuse Holders								
778-ANL Fuse Holder	LB-1	LBZ-2	LB-2	—	LB-1	LB-2	S:E LB-1 Gap LB-1	O: LB-2 C: LB-1
ANL Through Panel Fuse Holder	—	—	—	LB-2	—	—	—	—
ANL & Class T Double Stud Fuse Holders	LB-1	LBZ-2	LB-1	—	LB-1	LB-2	S:E LB-1 Gap LB-1	O: LB-2 C: LB-1
Insulated Studs								
Single Insulated Studs	LB-2	—	LB-2	—	LB-2	LBJ-2	LB-1	LBJ-2 C: LB-2
Double Insulated Studs	S:E LB-1 Gap LB-1	Gap LBZ-2	S:E LB-1 Gap LB-1	—	S:E LB-1 Gap LB-1	LB-1	S:S LBJ-2 Gap LB-1	O: LB-1 C: Gap LB-1
EZ Mount Battery Switches								
EZ Mount Battery Switch On/Off	O: LB-2 C: LB-1	LBZ-2	O: LB-2 C: LB-1	—	O: LB-2 C: LB-1	O: LBJ-2 C: LB-2	O: LB-1 C: Gap LB-1	LB-1
EZ Mount Selector Battery Switch -"Battery" Studs	LB-2 (4 Stud LB-1)	LBZ-2	LB-2	—	O: LB-1 C: LB-2	LBJ-2	LB-1	—
EZ Mount Selector Battery Switch -"Common" Stud	O: LB-2 C: LB-1	LBZ-2	O: LB-2 C: LB-1	—	O: LB-2 C: LB-1	O: LBJ-2 C: LB-2	O: LB-1 C: Gap LB-1	—
EZ Mount Double Pole/ Dual Bank Control	O: LB-2 C: LB-1	—	O: LB-2 C: LB-1	—	O: LB-2 C: LB-1	O or C: LB-1	O: LBJ-2 C: LBJ-2	LB-2

Side to Side Joining Selection Guide

	Marking
Joining 2 products	LBJ-2
Joining 3 products	LBJ-3
Joining 4 products	LBJ-4
Joining 5 products	LBJ-5
Joining 6 products	LBJ-6

Pro Installer Link Bars

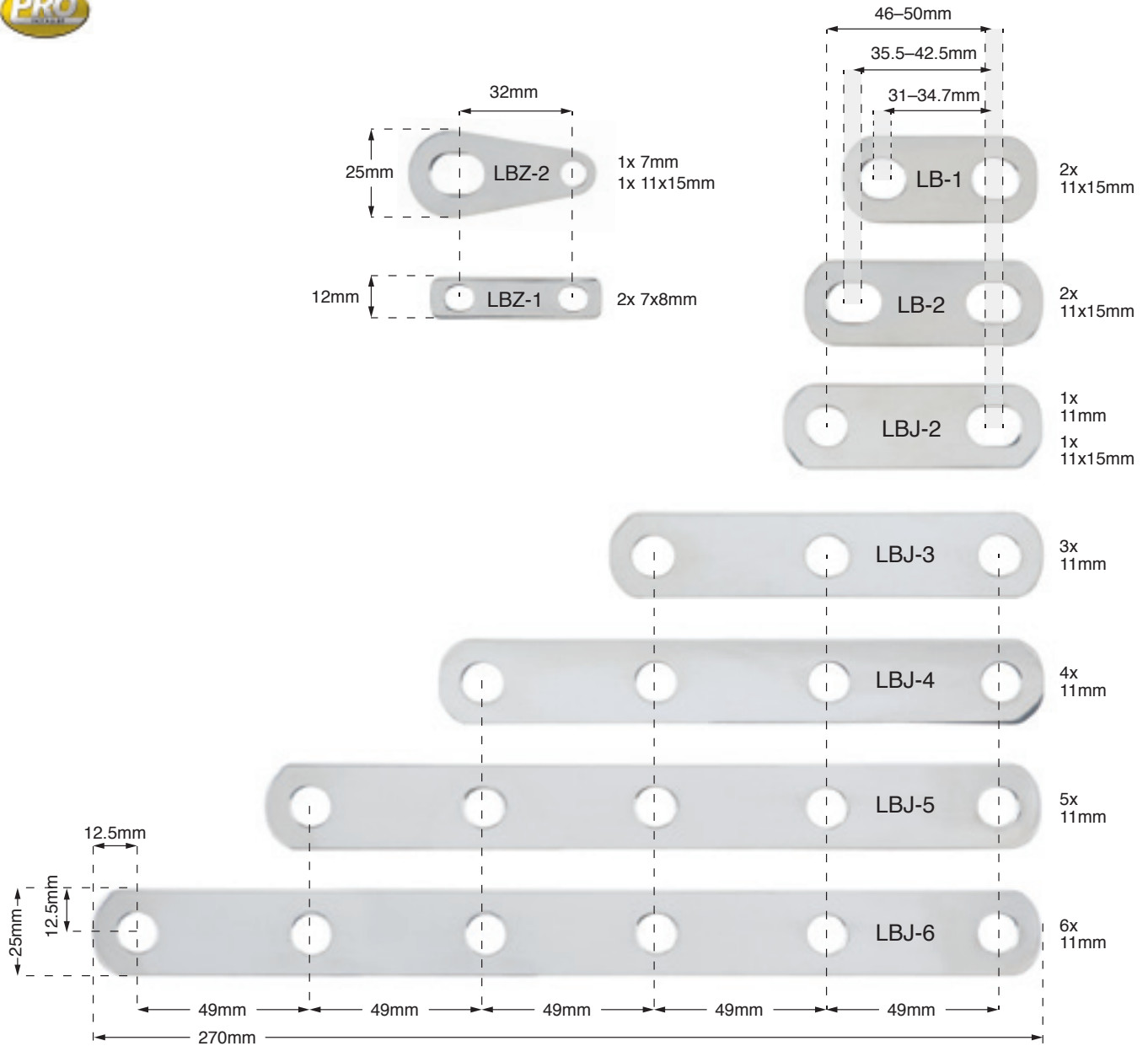

Specifications

Marking	OEM #	Pkg Qty	Description	Function	Max. Amps	L x W	L x W
LB-1	779-LB-1-B	5	Link Bar 31-34.7 mm	Short Link Bar 8 & 10 mm studs	650A	2.2" x 1.0"	56 x 25 mm
LB-2	779-LB-2-B	5	Link Bar 35.5-42.5 mm	Medium Link Bar 8 & 10 mm studs	650A	2.8" x 1.0"	69 x 25 mm
LBJ-2	779-LBJ-2-B	1	Joiner 2-way 46-50 mm	Long Link Bar 8 & 10 mm studs	650A	3.0" x 1.0"	74 x 25 mm
	779-LBJ-2-B5	5					
LBZ-1	779-LBZ-1-B	5	Link Z Bar to Z Bar	Joins Z Bars End to End, Back to Back	250A	2.0" x 0.5"	49 x 12 mm
LBZ-2	779-LBZ-2-B	5	Link Z Bar to Bus Bar or F-holder	Joins Z Bars to Bus Bars or F-holders	400A	2.1" x 1.0"	53 x 25 mm
LBJ-3	779-LBJ-3-B	1	Joiner 3-way	Side to Side joiner 3 products	525A	4.9" x 1.0"	123 x 25 mm
LBJ-4	779-LBJ-4-B	1	Joiner 4-way	Side to Side joiner 4 products	450A	6.9" x 1.0"	172 x 25 mm
LBJ-5	779-LBJ-5-B	1	Joiner 5-way	Side to Side joiner 5 products	400A	8.8" x 1.0"	221 x 25 mm
LBJ-6	779-LBJ-6-B	1	Joiner 6-way	Side to Side joiner 6 products	350A	10.8" x 1.0"	270 x 25 mm

Diagrams

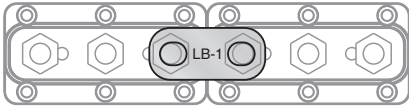

E:E End to End linking

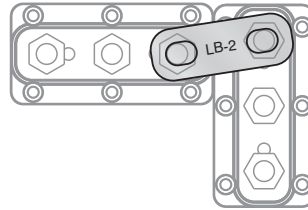

S:E Side to End linking

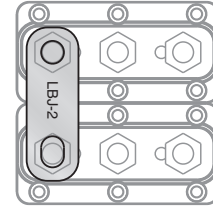

S:S Side to Side joining

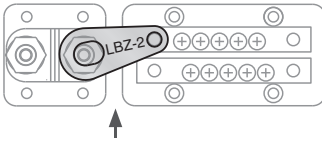

Gap For small gaps between products

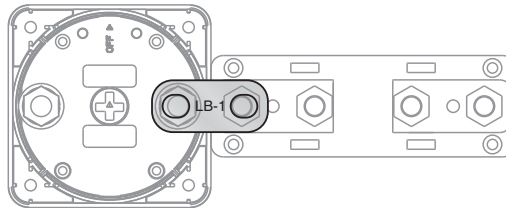

C: Centerline linking

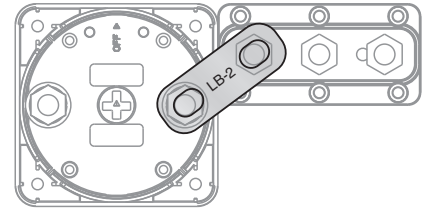

O: Offset linking

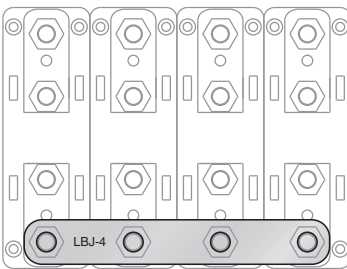

Joining

Best Electrical Practice for High Loads:

- Supply power to the center of link bars or bus bars to balance loads
- Connect highest loads directly/closest to the supply cable

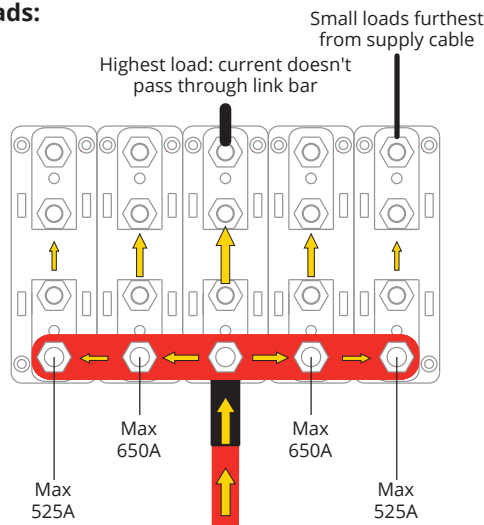

Note: Link bars can be doubled to increase load capacity

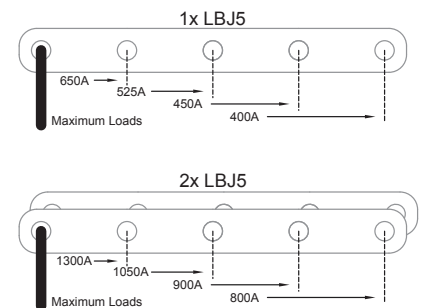

Pro Installer Clusters



Example shown below using Pro Installer distribution components, link bars and the award winning EZ-Mount Battery Switch (page 14).

- Saves time
- Saves space
- Eliminates the need for jumper wires between products
- Common Interconnection heights allow "clustering" utilizing solid link bars
- Customize clusters for your application

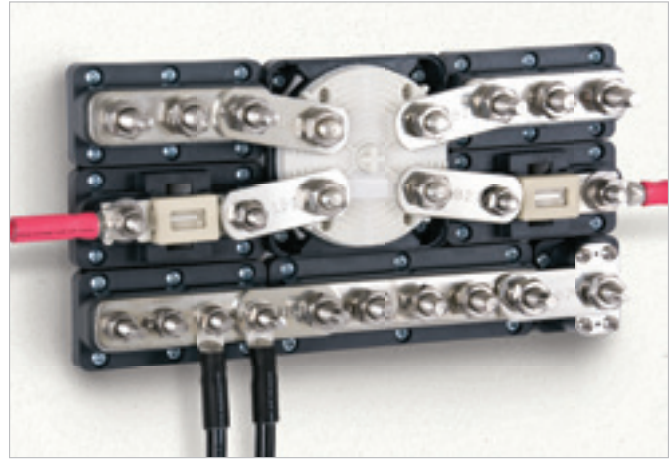

Insulated Studs & Covers

- Made with high temperature plastic bases
- Dual studs ideal for +ve / -ve connections, branch circuits, windlass or inverter installations.
- Stud covers push securely over the threaded stud covering to ABYC standards
- Covers supplied with display versions.



Single Studs

Part #	OEM #	Stud Size	Polarity
IS-6MM-1R/DSP*	IS-6MM-1R	1/4" (6 mm)	Positive
IS-6MM-1/DSP*	IS-6MM-1	1/4" (6 mm)	Negative
—	IS-8MM-1	5/16" (8 mm)	Negative
—	IS-10MM-1R	3/8" (10 mm)	Positive
—	IS-10MM-1	3/8" (10 mm)	Negative

*Part #'s come with cover, OEM #'s do not.

Dual Studs

Part #	OEM #	Stud Size
IS-6MM-2/DSP*	IS-6MM-2	2x 1/4" (6 mm)
—	IS-10MM-2	2x 3/8" (10 mm)
—	IS-10MM-2/L	2x 3/8" (10 mm) with link plate
—	IS-10MM-8MM	1x 3/8" (10 mm), 1x 5/16" (8 mm)

*Part #'s come with cover, OEM #'s do not.

Covers

Part #	Description	Color
ISC-6-2	Double 6 mm	black
ISC-6-2R	Double 6 mm	red
ISC-10BK	Single 10 mm	black
ISC-10R	Single 10 mm	red



Bus Bars

- Now with easy-fit covers to ABYC standards, with polarity ID
- 5/32" (4 mm) stainless steel screws with shakeproof washers
- 2 x 1/4" (6 mm) input studs
- Tin-plated, brass-insulated mounting bases with recessed mounting holes to avoid accidental shorts on aluminum surfaces
- Supplied standard with all BEP AC & DC control panels
- Display pack versions supplied with cover



BB-6W-2S
4.6" x 0.6" x 1.1"
117 x 15 x 29 mm

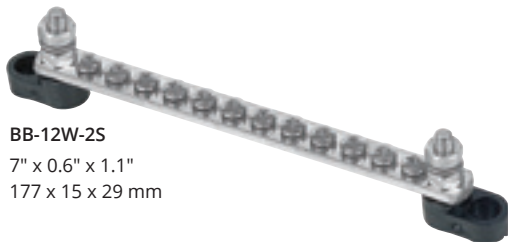

BB-12W-2S
7" x 0.6" x 1.1"
177 x 15 x 29 mm

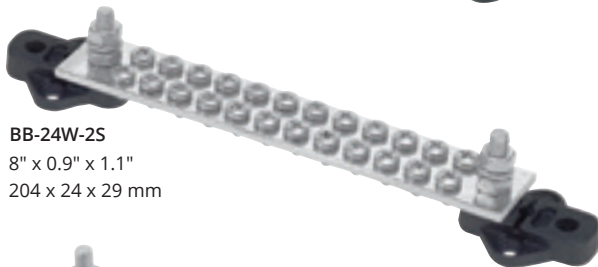

BB-24W-2S
8" x 0.9" x 1.1"
204 x 24 x 29 mm

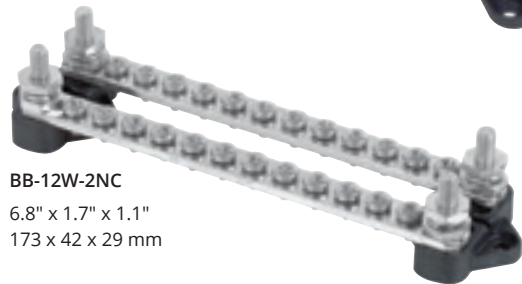

BB-12W-2NC
6.8" x 1.7" x 1.1"
173 x 42 x 29 mm

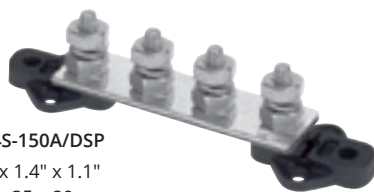

BB-4S-150A/DSP
5.4" x 1.4" x 1.1"
138 x 35 x 29 mm

Part #	OEM #	Bus Type	Output screws	Input studs	Rating
BB-6W-2S/DSP	BB-6W-2S	Single	6	2	100A
BB-12W-2S/DSP	BB-12W-2S	Single	12	2	100A
BB-24W-2S/DSP	BB-24W-2S	Single	24	2	150A
BB-12W-2NC/DSP	BB-12W-2NC	Double	2 x 12	2 x 12-way	100A
BB-4S-150A/DSP	BB-4S-150A	4-way	1 x 4	4 x 6 mm (1/4 stud)	150A

Bus Bar Covers

- Flame-resistant flexible plastic
- Color-coded for polarity
- Unique push-on fit
- Supplied standard with bus bars when ordered in display packs (for bulk packaging ordered separately)



6 W
BBC-6WR Positive
BBC-6WBK Negative



12 W
BBC-12WR Positive
BBC-12WBK Negative



24 W
BBC-24WR Positive
BBC-24WBK Negative

Terminal Blocks

Ideal for isolated connections up to 30A. Suitable for connecting tails from AC and DC panels.

Base material: Phenolic; Current rating 30A; Max. voltage rating: 300V AC/DC; Screw size: 0.25" (6.3 mm)

- TB-118-6P 6 connections
- TB-118-10P 10 connections

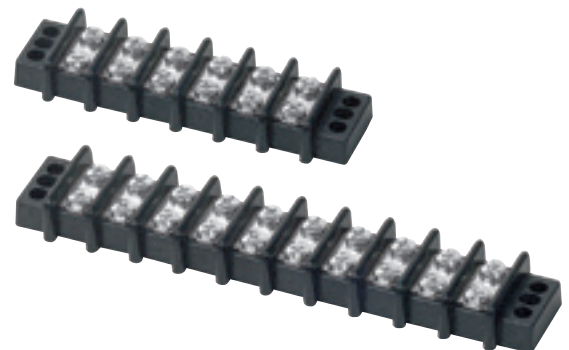



Distribution Stud

The Heavy-Duty Distribution Stud allows terminating of heavy-duty cables for one or more connections. Contour Lock housing has removable side plates which allows for connections from all sides.

OEM # 702B



Dual Distribution Stud

Designed specifically for transom areas for connecting battery cables from outboards. It also has many other applications where heavy-duty positive and negative connections need to be terminated.

OEM # 702-2S/B



4-way Distribution Stud

The 704-4S was designed for multiple heavy-duty connections which need to be isolated from each other. This model completes the range of heavy-duty connectors and meets ABYC standards for exposed terminals.

OEM # 704-4S/B

The patented Contour Locking System is an innovative feature that allows for multiple battery management components to be connected to each other providing a clean finished installation. These locking tabs can be found on battery switches, heavy-duty buss bars, fuse holders, distribution studs and breaker modules.

Description	Stud Size	OEM #	LxWxH in	LxWxH mm
Distribution Stud	10 mm (3/8")	702B	2.75" x 2.75" x 2"	69 x 69 x 50 mm
Dual Distribution Stud	2x 10 mm (3/8")	702-2S/B	2.75" x 2.75" x 2"	69 x 69 x 50 mm
	1x 8 mm (5/16") 1x 10 mm (3/8")	702-8-10-B	2.75" x 2.75" x 2"	69 x 69 x 50 mm
Dual Distribution Stud with Link Plate	2x 10 mm (3/8")	702-2SB/L	2.75" x 2.75" x 2"	69 x 69 x 50 mm
4-way Distribution Stud	4x 10 mm (3/8")	704-4S/B	5.3" x 2.75" x 2"	138 x 69 x 50 mm



Terminal Links

The 708 links are designed for space saving interconnections of terminals when battery distribution modules are linked together. Four standard solid links are available for interconnection of the 701 battery switch with other Battery Distribution products and two larger links which are intended for the heavy-duty battery switch.

Part #	Distance between centers	Hole diameter
708-42.5	1.7" (43 mm)	3/8" (10 mm)
708-54.5	2.2" (55 mm)	3/8" (10 mm)
708-64.5	2.5" (65 mm)	3/8" (10 mm)
708-68.5	2.7" (69 mm)	3/8" (10 mm)
708-62.0	2.45" (62 mm)	1/2" (12 mm)

Secondary Bus

Fitted to Distribution Stud 702 allows for small wire connections without cluttering main stud. Terminal screws 1/8" (4 mm).

Part # 702SB

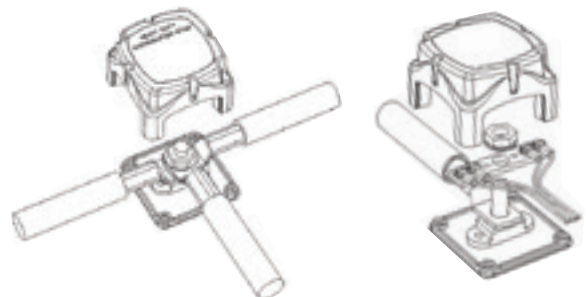



24hr Service Circuit Breaker Module (4W)

Consists of 1 x 5A and 3 x 15A push to reset Carling CLB Series thermal CBs. Suitable for essential circuits such as bilge pump, auto float switch supplies and stereo memory circuits. The push to reset function ensures essential 24-hour circuits cannot be switched off inadvertently. This is contained in the contour lock double module. Labels: SET-714

Part # 706-4WB
OEM # 706-4W/B



Contour Circuit Breaker

Allows switchable protection for heavy-duty circuits like Windlasses or Davit winches using Busman Heavy-duty thermal circuit breakers (120). Modular sizing with Contour Lock housing allows easy grouping. LED to indicate circuit is on. Five standard ratings available.

Part #	OEM #	Rating
705-50A	705-50A/B	50A
705-80A	705-80A/B	80A
705-100A	705-100A/B	100A
705-135A	705-135A/B	135A
705-150A	705-150A/B	150A



24hr Essential Circuit Module

Designed for smaller systems where only two circuit breakers are required. Supplied with 2 x 10A Carling CLB Series circuit breakers – push to reset.

Part # 706-2W
OEM # 706-2W/B



Circuit Breaker Module

Provides three CBs ideal for medium duty loads, like waste treatment systems and electric toilets. Designed to separate these loadings from the main DC panel, avoiding voltage spikes. Supplied standard with 1 x 50A and 2 x 25A B Series CBs in a Contour Lock housing for easy modulation. Extra CBs available (page 51).

Labels ordered separately: SET-714.
Part # 707

Related Products



CLB Series Push Reset Thermal Circuit Breakers page 50

Related Products



IEG Magnetic CB's page 51

Specifications

Part #	OEM #	Rating	LxWxD	LxWxD	Stud Size
707	—	1x 50A, 2x 25A	5.4" x 2.71" x 3"	138 x 69 x 75 mm	3/16" (5 mm)
705-50A	705-50A/B	50A	5.4" x 2.71" x 3"	138 x 69 x 75 mm	1/4" (6 mm)
705-80A	705-80A/B	80A	5.4" x 2.71" x 3"	138 x 69 x 75 mm	1/4" (6 mm)
705-100A	705-100A/B	100A	5.4" x 2.71" x 3"	138 x 69 x 75 mm	1/4" (6 mm)
705-135A	705-135A/B	135A	5.4" x 2.71" x 3"	138 x 69 x 75 mm	1/4" (6 mm)
705-150A	705-150A/B	150A	5.4" x 2.71" x 3"	138 x 69 x 75 mm	1/4" (6 mm)
706-4WB	706-4W/B	1x 5A, 3x 15A	5.4" x 2.71" x 3"	138 x 69 x 75 mm	5/32" (4 mm)
706-2W	706-2W/B	2x 10A	2.71" x 2.71" x 2.75	69 x 69 x 70 mm	5/32" (4 mm)

CIRCUIT PROTECTION & SWITCHES

Marine Fuses



46

Fast-acting, corrosion resistant fuses open quickly to protect circuits from overloads and short-circuits.

Fuse Holders

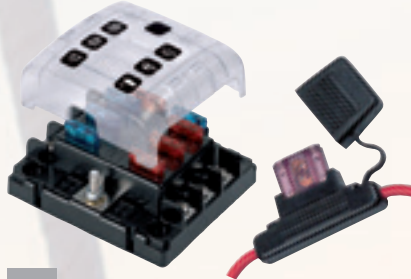

47

For protection of smaller systems and branch circuits, for ATO/ATC and Maxi fuse ranges.

Marine Rated Battery Fuse



48

Highly compact fuses/holders which are ignition protected and able to protect main supply connections.



CIRCUIT PROTECTION & SWITCHES

Thermal Circuit Breakers



49

Thermal Circuit Breakers & RCD's:
Major DC circuit protection from 30-200A,
push to reset breakers for 10-40A circuits,
and RCD/RCBO panels for AC
Main circuit protection.

Magnetic Circuit Breakers



51

Precision operation circuit breakers,
5-100A, single, double and triple pole.

Switches

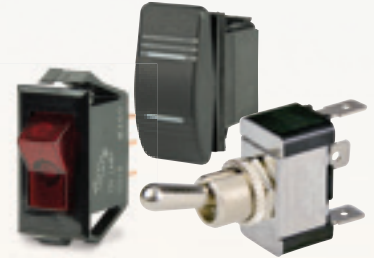

52

BEP Marine now offers a full line of
manual switches including: toggle, rocker,
push/pull, push-button, solenoids, and
relays. The comprehensive selection
ensures that BEP has the right switch to
meet your needs.



Marine Fuses

- Fast-acting, corrosion resistant fuses open quickly to protect circuits from overloads and short-circuits.
- Time-delayed to allow temporary, harmless in-rush currents to pass but open on sustained overloads and short-circuits.



ATO®/ATC® Fuses

Diameter: 3/4" (19 mm)

Length: 3/4" (19 mm)

Maximum voltage: 32V DC

Rating (A)	Qty/Pkg	OEM #
1	1	J01A
2	1	J02A
3	1	J03A
5	1	J05A
7.5	1	J7.5A
10	1	J10A
15	1	J15A
20	1	J20A
25	1	J25A
30	1	J30A
40	1	J40A



MAXI® Fuses

Fuses available: 30-80A

Interrupt capacity: 1000A DC

Maximum voltage: 32V DC

Rating (A)	Qty/Pkg	Part #	OEM #
30	1	BFHD-30A/DSP	BFHD-30A
40	1	BFHD-40A/DSP	BFHD-40A
50	1	BFHD-50A/DSP	BFHD-50A
60	1	BFHD-60A/DSP	BFHD-60A
70	1	BFHD-70A/DSP	BFHD-70A
80	1	BFHD-80A/DSP	BFHD-80A



ANL Fuses

Use with:

- Pro Installer ANL Fuse Holders (page 35) 
- Tin plated
- Visible fuse status window
- 48V DC voltage rating
- Up to 3000A interrupt capacity

Length: 3.23" (82 mm)

Width: 0.88" (22 mm)

Stud clearance: 0.43" (11 mm)

Rating (A)	Qty/Pkg	Part #	OEM #
20	1	—	77049020
40	1	—	IP40
50	1	IP50P/DSP	IP50
63	1	IP63P/DSP	IP63
80	1	IP80P/DSP	IP80
100	1	IP100P/DSP	IP100
125	1	—	IP125
150	1	IP150P/DSP	IP150
160	1	—	77049160
175	1	—	IP175
200	1	IP200P/DSP	IP200
250	1	IP250P/DSP	IP250
300	1	IP300P/DSP	IP300
355	1	—	IP355
400	1	—	77049400
425	1	IP425P/DSP	IP425
500	1	IP500P/DSP	IP500



Heavy-duty ANL Fuses

Use with:

- 5/16" (8 mm) mounting studs
- Pro Installer ANL Fuse Holders (page 35) 

Rating (A)	Qty/Pkg	OEM #
600	5	FANL-600-B
675	5	FANL-675-B
750	5	FANL-750-B



Class T Fuses

Interrupt capacity: 20,000A DC

Maximum voltage: 160V DC

Diameter: 1.34" (34 mm)

Length: 2.77" (70 mm)

Use with:

- Pro Installer Class T Fuse Holders (page 35) 

Rating (A)	Qty/Pkg	OEM #
225	1	FT-225-B
250	1	FT-250-B
300	1	FT-300-B
350	1	FT-350-B
400	1	FT-400-B

Heavy-duty Class T Fuses

Interrupt capacity: 20,000A DC

Maximum voltage: 160V DC

Diameter: 1.62" (41 mm)

Length: 3.03" (77 mm)

Use with:

- Pro Installer Class T Fuse Holders (page 35) 

Rating (A)	Qty/Pkg	OEM #
450	1	FT-450-B
500	1	FT-500-B
600	1	FT-600-B

Fuse Holders



ATC-6W

ATO®/ATC® Fuse Holders

The BEP ATC Fuse Holder provides compact, easy access to fuses with the design integrity only BEP can offer.

- Allows for multiple fuse holders and bus bars to be joined together, increasing the number of circuits protected
- Fuse holder inputs can be linked together to form a single continuous fuse holder
- Includes patented Contour Lock system, see-thru clip-on cover and label set
- Available with screw terminals or quick connect terminals
- Max. current/circuit: 30A; Max. current/block: 100A; Max. voltage: 32V DC; Base & cover material: polycarbonate
- Positions for spare fuses
- ATC Fuse holder: 3.1" x 3.54" x 1.85" (80 x 90 x 47 mm)
- ATC Bus bar: 1.3" x 3.54" x 1.85" (35 x 90 x 47 mm)

Description	Pack Qty	Part #	OEM #
6-way fuse holder screw terminals w/ cover & link	1/blister	ATC-6W	—
6-way fuse holder Quick Connect w/ cover & link	1/blister	ATC-6WQC	—
6-way negative bus, 5 mm stud, cover, joiners	1/blister	80-712-0039-00	—
6-way fuse holder screw terminals w/ cover	24/pack	—	ATC-6W/B
6-way negative bus, 5 mm stud, cover, joiners	24/pack	—	80-712-0039-01



BB-LINK17MM

Allows two 6-way ATC fuse holders to be joined together providing twelve fused positions running off one feed.



80-712-0039-00

ATO®/ATC® Bus Bar

The expandable ATC negative Bus uses the BEP Contour Lock system to allow it to be joined to the ATC fuse holder. This keeps wiring tidy and conveniently located.

Current rating 100A.

MAXI® Fuse Holder

An economical way of fusing heavy loads 30–80A. Ideal for battery charger outputs or mains feeds. 1/4" (6 mm) studs accept ring terminals and cables up to 25 mm² (4 gauge). Fuse is clamped between tinned brass clamps for positive connection. Covers enclose exposed terminals to meet ABYC standards.

2.8" x 2" x 1.42" (71 x 53 x 36 mm)

Part # 702-MFH

OEM # 702-MFH-B



Inline MAXI® Fuse Holder

For installations where space is tight and fuse needs to be installed inline with the cable.

Supplied with 8 mm (8G) tails for inline connections. An economical solution to heavy-duty fusing.

3.15" x 2.15" x .6" (80 x 55 x 15 mm)

OEM # HDBFH



Inline ATC Fuse Holder

Part # WAFH-14



Marine Rated Battery Fuse

Features:

- Weatherproof IP66 design (see inside back cover)
- Compact heavy duty protection
- Insulated cap to prevent short circuit
- Ignition Protected
- Easy installation
- Suitable for high capacity battery banks



MRBF
Terminal mount heavy-duty fuse holder and cover



Specifications:

- **Voltage Rating:** 58V DC Maximum
- **Amperage Rating:** 30A - 300A
- **Ingress Protection:** IP66
- **Ignition Protected:** Per SAEJ1117
- **Interrupt Rating:** 10000A @ 14V DC, 5000A @ 32V DC, 2000A @ 58V DC
- **Torque Rating:** Maximum 12Nm (106 in-lbs)
- **Material:** Body – Ceramic, Housing & Cover: UL-rated 94V0
- Thermoplastic, Ring Terminals - Tin Plated
- **Compliances:** ISO 8820-6
- Available in other sizes upon request, from 30–300A

Rating (A)	Qty/ Pkg	Part #	OEM #
50	1	MRBF-50A	MRBF-50A-B
80	1	MRBF-80A	MRBF-80A-B
100	1	MRBF-100A	MRBF-100A-B
125	1	MRBF-125A	MRBF-125A-B
150	1	MRBF-150A	MRBF-150A-B
200	1	MRBF-200A	MRBF-200A-B
300	1	MRBF-300A	MRBF-300A-B

Single Pole Switchable Manual Reset Thermal Circuit Breaker

Features:

- Weatherproof IP66 design (see inside back cover)
- Trip free safety feature
- Switchable circuit protection
- Easy installation/ operation
- Ignition Protected
- CE Approved

Specifications:

- **Rating:** 25-200A, 48V DC
- **Interrupt Rating:** Main Breaker Protection Interrupt Rating (5,000A@ 14V DC, 3,000A@ 28V DC and 1,500A@ 48V DC)
- **Operating Temperature Rating:** -40°F (-40°C) to 185°F (85°C)
- **Storage Temperature Rating:** -40°F (-40°C) to 260°F (125°C)
- **Materials:** Black UL-rated 94V0 thermoset plastic body
- Cover and lever are UL-rated 94V0 thermoplastic
- **Marking:** Standard marking includes amp/volt ratings
- **Termination:** 5/16-18 threaded studs
- **Torque Rating:** 75 in-lbs (8.5Nm) max
- **Mounting Torque Rating:** Panel or surface-mount options; 50 in-lbs (5.6 Nm) max
- **Ingress Protection Rating:** IP66
- **Compliances:** ABYC E-11; CE; SAE J1171 (ignition protected)
- Available in other sizes upon request, from 25–150A



MRCBF-200A



MRCBP-200A

Mounting	Rating (A)	Part #	OEM #
Surface	200	MRCBF-200A	MRCBF-200A-B
Panel	200	MRCBP-200A	MRCBP-200A-B

Single Pole Thermal Type Breakers

- **Ratings:** 30–150A; 30V DC
- **Interrupt Capacity:** 3000A
- **Operating Temperature:** -25°F (-32°C) to 180°F (82°C)
- **Storage Temperature:** -30°F (-34°C) to 300°F (149°C)
- **Applications:** Auxiliary and accessory circuits – trucks, buses, RVs and marine applications, battery chargers and DC audio systems. Series 184 & 185 are sealed for engine compartment and bilge area applications.
- **Housing:** Thermoset plastic; UL rated 94VO; 311°F (155°C). Stud insulators are provided on covered units with F (Surface Mount) bases; tin plated copper studs, brass rivets and stainless steel locking nuts.
- **Mounting:** Panel or surface
- **Terminal Stud Torque:** 50 in-lb (5.6Nm) max.
- **Indicator:** Series 184 & 185 have a unique reset mechanism providing visible indication of tripped condition
- **Ingress Protection Rating:** IP67 (see inside back cover)
- **Approvals:** Complies with SAEJ1625, J1171 and UL1500 (Ignition protected) specifications.



185100F-01-1

Switchable reset versions can be manually switched to isolate the circuit

Switchable Reset

Rating (A)	Panel Mount Part #	Panel Mount OEM #	Surface Mount Part #	Surface Mount OEM #
30	185030P/DSP	185030P-01-1	185030F/DSP	185030F-01-1
40	185040P/DSP	185040P-01-1	185040F/DSP	185040F-01-1
50	185050P/DSP	185050P-01-1	185050F/DSP	185050F-01-1
60	185060P/DSP	185060P-01-1	185060F/DSP	185060F-01-1
70	185070P/DSP	185070P-01-1	185070F/DSP	185070F-01-1
80	185080P/DSP	185080P-01-1	185080F/DSP	185080F-01-1
100	185100P/DSP	185100P-01-1	185100F/DSP	185100F-01-1
120	185120P/DSP	185120P-01-1	—	185120F-01-1
135	185135P/DSP	185135P-01-1	—	185135F-01-1
150	185150P/DSP	185150P-01-1	185150F/DSP	185150F-01-1

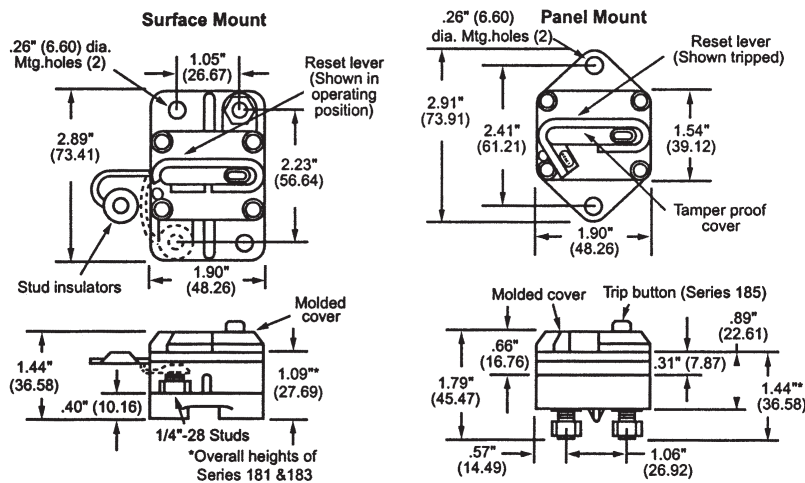

Temperature and Current Rating

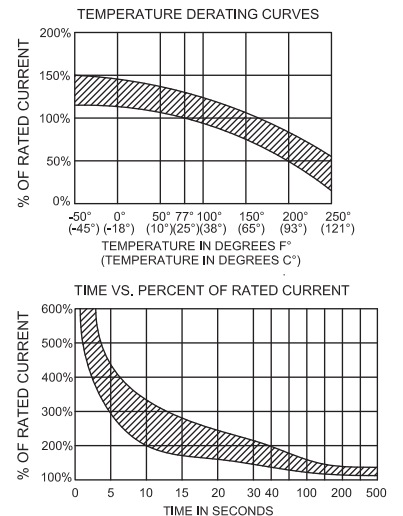

CLB Series Push Reset Thermal Circuit Breakers

- **Ratings:** 5–40A; 200A @ 250V AC Interrupt Capacity
- **Operating Temperature:** 14–140°F (-10–60°C)
- **Interrupting capacity:** 2500A
- **Resettable overload capacity:** 10 x rated current
- **Approvals:** UL, CUL, TUV, CE, UL1500, ISO8846 for ignition protection/marine

Rating (A)	Part #*	OEM #
5	CLB-05/DSP	CLB-05
10	CLB-10/DSP	CLB-10
15	CLB-15/DSP	CLB-15
20	CLB-20/DSP	CLB-20
25	CLB-25/DSP	CLB-25
30	CLB-30/DSP	CLB-30
40	CLB-40/DSP	CLB-40

*DSP versions include circuit breaker, washer and boot

Description	OEM #
Boot	CLB-BOOT
Washer	PMCC-10



CLB-BOOT
Boot required to install breaker.

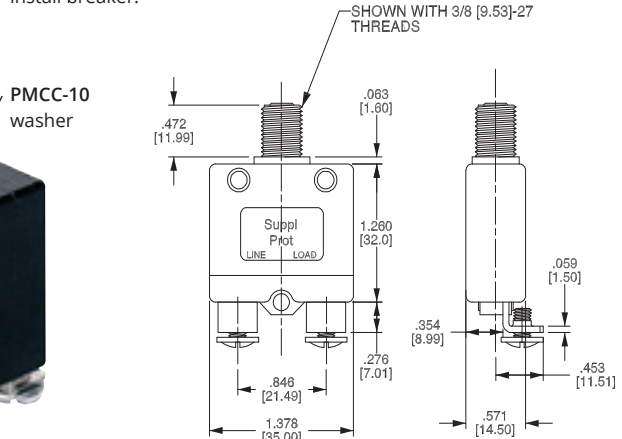

RCD Panels

We supply two Residual Current Devices (RCD) ratings (16 & 32A). These also act as a circuit breaker (RCBO type), have an insulation rating of 400V AC, make/brake current of 6000A, a 30mA trip rating against electric shocks, and 300mA trip protection against fire risks. Due to the different mounting dimensions of the RCD's, these panels are made to be mounted separately from the main AC panel.

Rating (A)	Part #	HxWxD	HxWxD
16	900-RCD-16A	4.5" x 5" x 2.5"	115 x 127 x 65 mm
32	900-RCD-1X16-32A	4.5" x 5" x 2.5"	115 x 127 x 65 mm
16x2	900-RCD-2X16A	4.5" x 5" x 2.5"	115 x 127 x 65 mm
32x2	900-RCD-2X32A	4.5" x 5" x 2.5"	115 x 127 x 65 mm
16x1, + 32x1	900-RCD-32A	4.5" x 5" x 2.5"	115 x 127 x 65 mm

Cutout size - 3/8" (10 mm) inside all external edges



900-RCD-16A



900-RCD-2X16A

CB Options

- 230V

Rating (A)	Part #	Type
16	NHP-RCBO-16A30MA-1D	Residual CB Overload
16	NHP-RCBO-16A30MA-2D	Residual CB Overload
32	NHP-RCBO-32A30MA-1D	Residual CB Overload
32	NHP-RCBO-32A30MA-2D	Residual CB Overload



RCBO
(see chart)



MCB-3WENC
6.3" x 3.6" x 3.5"
160 x 92 x 90 mm



124001000
7.87" x 4.33" x 4.53"
200 x 110 x 115 mm

For installations in Australia and New Zealand to comply with AS/NZ3004 an approved double pole mains circuit breaker must be mounted upstream of the BEP Control Panel. The MCB-3WENC is an enclosure with IP65 rating. The enclosure and CB are ordered separately. The Shore Fix is already assembled, no additional item parts need to be ordered.

IEG Magnetic Circuit Breakers

IEG Magnetic Circuit Breakers provide reliable circuit protection and accurate circuit control for equipment in the international market place. Designed using the latest in sensitive hydraulic magnetic technology, the IEG line adapts itself to many applications and environments. They are ideal for marine applications, data processing and business machines, as well as medical instrumentation, broadcast equipment, vending and amusement machines, military applications and wherever precision operation is required. Temperature differences which affect fuses and other thermal devices are not a concern. One important feature of this breaker line is a 'trip free' action, which means the circuit will trip in the presence of an overload even though the handle is held in the ON position. The delay mechanism senses the fault and the contacts open.

- Spacing compliance: IEC specification 601, 950; VDE 0804, 0805
- UL Recognized UL 1077; CSA certified per CSA C22.2 - No.235; Complies with EN 60947-2 & EN 60934
- Available in single or double pole; triple pole available on special orders

Single pole	Rating (A)	Double pole	Rating (A)	Triple pole	Rating (A)
CBS-5A-SP	5	CBS-10A-DP	10	CBS-50A-TP	50
CBS-10A-SP	10	CBS-15A-DP	15	Double pole trip coil pole* Volts (V)	
CBS-15A-SP	15	CBS-20A-DP	20		
CBS-20A-SP	20	CBS-25A-DP	25		
CBS-25A-SP	25	CBS-30A-DP	30		
CBS-30A-SP	30	CBS-40A-DP	40		
CBS-40A-SP	40	CBS-50A-DP	50	CBS-15A-DP-TC230	230
CBS-50A-SP	50			CBS-20A-DP-TC230	230
CBS-50A-SP-IGP°	50			CBS-30A-DP-TC230	230
				CBS-50A-DP-TC230	230

Compatible with BEP panels.



CBS-50A-SP

CBS-50A-DP

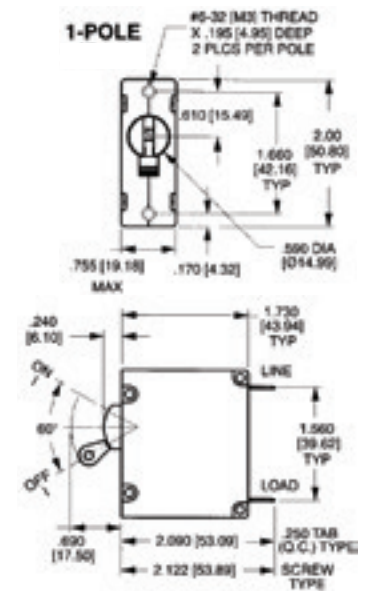

Handle Lock

Image shows "handle lock" as used in all our battery management panels for essential CBs to prevent accidental or unintended actuation of essential circuits CB's from either the "on" or "off" position. (ordered separately)

Part # 121-710-1101/1

IUL Magnetic Circuit Breakers

Provide reliable circuit protection and accurate circuit control for equipment in the international market place. BEP uses the IUL range of circuit breakers where current requirements exceed 50A and are within 100A. Available in single and double pole with triple pole available on special orders.

Single pole	Rating (A)	Double pole	Rating (A)	Triple pole	Rating (A)
CBL-50A-SP	50	CBL-60A-DP	60	CBL-80A-TP	80
CBL-60A-SP	60	CBL-100A-DP	100	CBL-100A-TP	100
CBL-75A-SP	75				
CBL-100A-SP	100				

Compatible with BEP panels.



CBL-50A-SP

CBL-100A-DP

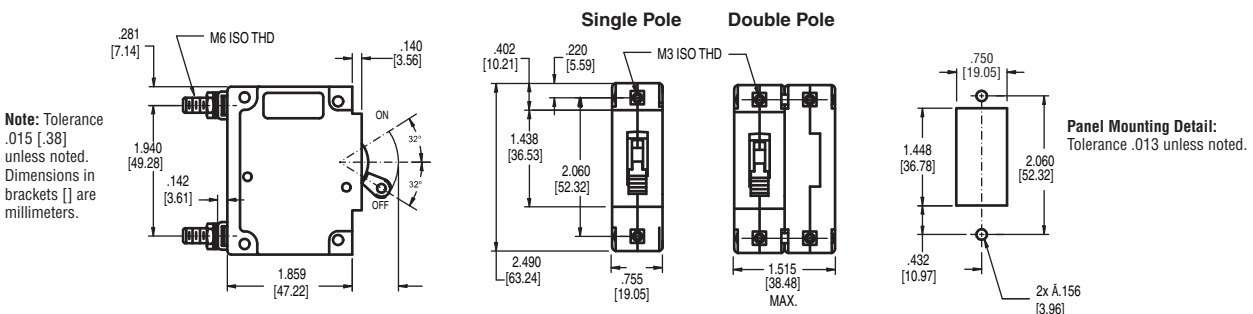

Switches

We have expanded our line to cover all of your manual switch needs.

BEP Marine now offers a full line of manual switches including: toggle, rocker, push/pull, push-button, solenoids, and relays. The comprehensive selection ensures that BEP has the right switch to meet your needs. All of our switches are shock and weather resistant and built for harsh marine and industrial environments. In addition, common applications are associated with each style to simplify selection. BEP switches are available in the following classifications:



SPST

Single Pole, Single Throw:

- Turns a single circuit on and off
- One input and one output terminals



DPST

Double Pole, Single Throw:

- Turns two circuits on simultaneously
- Two input and two output terminals
- Each input terminal has a dedicated output terminal



SPDT

Single Pole, Double Throw:

- Turns one of two circuits on and off
- One input and two output terminals



DPDT

Double Pole, Double Throw:

- Turns one circuit in each of two pairs of circuits
- Two input and four output terminals
- Enables different modes of operation on a circuit

Action	Style	Primary Use
SPST	Off-On	Lights
SPST	Off-(On)	Horn
SPDT	On-Off-On	Nav Lights
SPDT	(On)-Off-On	Bilge Pump
SPDT	On-Off-(On)	Bilge Pump
SPDT	(On)-Off-(On)	Trim Tabs
SPDT	On-On	Hallway Lights

Action	Style	Primary Use
DPST	Off-On	Nav Lights
DPST	Off-(On)	Dual Horns
DPDT	On-Off-On	Nav Lights
DPDT	(On)-Off-On	Dual Wipers
DPDT	On-Off-(On)	Dual Wipers
DPDT	(On)-Off-(On)	Hatches
DPDT	On-On	Hallway Lights

() = Momentary



Contura Switches

- Shock and weather resistant for use in harsh marine and industrial environments
- Compatible with 12V and 24V systems, rated for up to 20A (12V)
- Standard or illuminated actuators
- Mount in BEP Rocker/Contura switch brackets

Ideal for:
 Interior and Exterior Lighting
 Trim Tabs
 Power Hatches
 Horns
 Wipers

Part #	1001801	1001802	1001803	1001805	1001804	1001806
Type	SPST		SPDT			
Action	Off-On	Off-(On)	On-Off-On	On-Off-(On)	(On)-Off-(On)	(On)-Off-(On)
Nominal Voltage	12V/24V DC	12V/24V DC	12V/24V DC	12V/24V DC	12V/24V DC	12V/24V DC
Ratings	20A at 12V DC, 15A at 24V DC	20A at 12V DC, 15A at 24V DC	20A at 12V DC, 15A at 24V DC	20A at 12V DC, 15A at 24V DC	20A at 12V DC, 15A at 24V DC	20A at 12V DC, 15A at 24V DC
Termination Type	1/4" blades	1/4" blades	1/4" blades	1/4" blades	1/4" blades	1/4" blades
LED	● 1-Amber	None	● 2-Amber	● 1-Amber	None	None

Part #	1001811	1001810	1001812	1001808	1001807	1001809
Type	DPST		DPDT			
Action	Off-On	Off-(On)	On-On	On-Off-On	On-Off-(On)	(On)-Off-(On)
Nominal Voltage	12V/24V DC	12V/24V DC	12V/24V DC	12V/24V DC	12V/24V DC	12V/24V DC
Ratings	20A at 12V DC, 15A at 24V DC	20A at 12V DC, 15A at 24V DC	20A at 12V DC, 15A at 24V DC	20A at 12V DC, 15A at 24V DC	20A at 12V DC, 15A at 24V DC	20A at 12V DC, 15A at 24V DC
Termination Type	1/4" blades	1/4" blades	1/4" blades	1/4" blades	1/4" blades	1/4" blades
LED	● 1-Amber	None	● 2-Amber	● 2-Amber	● 1-Amber	None

() = Momentary

Contura and Rocker Switch Mounting Brackets

- Mount multiple Contura or Rocker style switches in one opening
- Provides a neat, finished appearance on dash or panel surfaces



1001718 Plug

1001717 Single

1001703 End (L or R)

1001702 Double

1001701 Triple (plug included)

Rocker Switches

- Shock and weather resistant for use in harsh marine and industrial environments
- Available in 12V and 24V system configurations
- 10A, 20A, and heavy-duty 25A (12V) rated options
- Standard and illuminated actuators

Ideal for:
 Interior and Exterior Lighting
 Horns
 Wipers
 Trim Tabs
 Power Hatches

Part #	1001705	1001707	1001708	1001714	1001716	1001704	1001709
Type	SPST						
Action	Off-On	Off-On	Off-On	Off-On	Off-On	Off-On	Off-(On)
Nominal Voltage	12V DC	12/24V DC	12V DC	12V DC	12V DC	12/24V DC	12V DC
Ratings	10A at 12V DC	20A at 12V DC, 10A at 24V DC	25A at 12V DC	25A at 12V DC	25A at 12V DC	20A at 12V DC, 15A at 24V DC	25A at 12V DC
Termination Type	1/4" blades	#8-32 screws	#8-32 screws	1/4" blades	1/4" blades	1/4" blades	1/4" blades
LED	● Red	None	● Red	● Red	● Changeable	None	None

Part #	1001706	1001710	1001715	1001711	1001712	1001713
Type	SPDT				DPDT	
Action	On-On	On-Off-On	On-Off-On	(On)-Off-(On)	On-Off-On	(On)-Off-(On)
Nominal Voltage	12V DC	12V DC	12V DC	12V DC	12V DC	12V DC
Ratings	10A at 12V DC	25A at 12V DC	25A at 12V DC	25A at 12V DC	25A at 12V DC	25A at 12V DC
Termination Type	1/4" blades	1/4" blades	1/4" blades	1/4" blades	1/4" blades	1/4" blades
LED	None	None	● 2-Red	None	None	None

() = Momentary

Contura and Rocker Switch Mounting Brackets

- Mount multiple Contura or Rocker style switches in one opening
- Provides a neat, finished appearance on dash or panel surfaces



1001718
Plug

1001717
Single

1001703
End (L or R)





1001702
Double

1001701
Triple (plug included)

Contact Switches

- Universal applications for marine and industrial environments
- Choose from red or black actuator styles

Ideal for:
 Horns
 Other Momentary Applications







		
Part #	1001401	1001402
Type	SPST	
Action	Off-(On)	Off-(On)
Nominal Voltage	12V DC	12V DC
Ratings	10A at 12V DC	10A at 12V DC
Termination Type	1/4" blades	1/4" blades
Button Color	 Red	 Black

() = Momentary

Push Button Switches and Caps

- Offered in a variety of weather resistant options to suit any application environment
- Suitable for 6–36V system configurations with up to 35A ratings (12V)
- Momentary actuation ideal for use with horns
- Optional weather proof rubber caps available with threaded or press-on installation

Ideal for:
 Horns

						
Part #	1001503	1001504	1001505	1001506	1001507	1001508
Type	SPST					
Action	Off-(On)	Off-(On)	Off-(On)	Off-(On)	Off-(On)	Off-(On)
Nominal Voltage	6–36V DC	6–36V DC	6–36V DC	6–36V DC	6–36V DC	6–36V DC
Ratings	10A at 12V DC	35A at 12V DC	10A at 12V DC	10A at 12V DC	35A at 12V DC	35A at 12V DC
Termination Type	#8–32 screws	#8–32 screws	#8–32 screws	wire leads, 16 AWG, 8"	#8–32 screws	#8–32 screws

() = Momentary

Push Button Caps















Toggle Switches





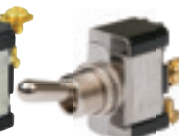

- Shock and weather resistant for use in harsh marine and industrial environments
- Available in 12V and 24V system configurations
- 10A and heavy-duty 25A (12V) rated options
- Standard or illuminated actuators

Ideal for:

- Interior and Exterior Lighting
- Horns
- Wipers
- Trim Tabs
- Power Hatches

						
Part #	1001901	1001906	1001902	1001908	1002010	1002006
Type	SPST					
Action	Off-On	Off-On	Off-On	Off-On	Off-On	Off-(On)
Nominal Voltage	12V DC	12V DC	12V DC	12V DC	12V/24V DC	12V/24V DC
Ratings	25A at 12V DC	25A at 12V DC	25A at 12V DC	25A at 12V DC	25A at 12V DC, 15A at 24V DC	25A at 12V DC, 15A at 24V DC
Terminal Type	1/4" blade	1/4" blade	#6-32 screws	#6-32 screws	wire leads, 14 AWG, 10"	wire leads, 14 AWG, 10"
LED	None	● Red	None	● Red	None	None

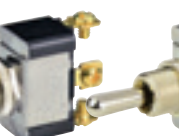
							
Part #	1002013	1002021	1002022	1002002	1002024	1002025	1002023
Type	SPST						
Action	Off-On	Off-On	Off-On	Off-(On)	On-Off	Off-On	Off-On
Nominal Voltage	12V/24V DC	12V DC	12V DC	12V DC	12V/24V DC	12V/24V DC	12V DC
Ratings	25A at 12V DC, 15A at 24V DC	10A at 12V DC	10A at 12V DC	25A at 12V DC	25A at 12V DC, 15A at 24V DC	25A at 12V DC, 15A at 24V DC	10A at 12V DC
Terminal Type	1/4" terminals	#6-32 screws	#6-32 screws	#6-32 screws	#6-32 screws	#6-32 screws	wire leads, 18 AWG, 6"
LED	None	None	None	None	None	None	None

							
Part #	1001907	1001903	1001904	1002001	1002027	1002015	1002004
Type	SPDT						
Action	On-Off-On	On-Off-On	(On)-Off-(On)	On-Off-On	On-Off-On	On-Off-(On)	(On)-Off-(On)
Nominal Voltage	12V DC	12V DC	12V DC	12V DC	12V DC	12V/24V DC	12V/24V DC
Ratings	25A at 12V DC	25A at 12V DC	25A at 12V DC	25A at 12V DC	25A at 12V DC	25A at 12V DC, 15A at 24V DC	25A at 12V DC, 15A at 24V DC
Terminal Type	1/4" blades	#6-32 screws	#6-32 screws	1/4" blades	#6-32 screws	#6-32 screws	#6-32 screws
LED	● Red	None	None	None	None	None	None

() = Momentary



Part #	1002008	1002007	1002009
Type	SPDT		
Action	On-On	On-Off-On	(On)-Off-(On)
Nominal Voltage	12V/24V DC	12V/24V DC	12V/24V DC
Ratings	25A at 12V DC, 15A at 24V DC	25A at 12V DC, 15A at 24V DC	25A at 12V DC, 15A at 24V DC
Terminal Type	wire leads, 14 AWG, 10"	wire leads, 14 AWG, 10"	wire leads, 14 AWG, 10"
LED	None	None	None

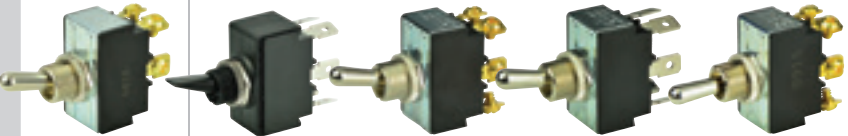

Part #	1002017	1001905	1002018	1002014	1002012
Type	DPST	DPDT			
Action	Off-On	On-Off-On	On-Off-On	On-Off-(On)	(On)-Off-(On)
Nominal Voltage	12V DC	12V DC	12V/24V DC	12V DC	12V/24V DC
Ratings	25A at 12V DC	25A at 12V DC	25A at 12V DC, 15A at 24V DC	25A at 12V DC	25A at 12V DC, 15A at 24V DC
Terminal Type	#6-32 screws	1/4" blades	#6-32 screws	1/4" blades	#6-32 screws
LED	None	None	None	None	None

Sealed Dipped Switches



Part #	1002016	1002003	1002011	1002005
Type	SPST		SPDT	
Action	Off-On	Off-(On)	On-Off-On	(On)-Off-(On)
Nominal Voltage	12V DC	12V/24V DC	12V/24V DC	12V/24V DC
Ratings	25A at 12V DC	25A at 12V DC, 15A at 24V DC	25A at 12V DC, 15A at 24V DC	25A at 12V DC, 15A at 24V DC
Terminal Type	wire leads, 16 AWG, 8"	wire leads, 16 AWG, 8"	wire leads, 16 AWG, 8"	wire leads, 16 AWG, 8"
LED	None	None	None	None

() = Momentary

Toggle Switch Boots

- UV resistant, resists cracking and discoloration
- Full boot provides maximum protection. IP67 rated, will withstand saltwater and fresh water immersion up to 30 min.
- Tipless boot provides increase weather resistance while retaining the look of the stainless actuator



Push-Pull Switches

- Push-Pull switches are well suited for managing a variety of single or multiple circuit lighting applications
- Shock and weather resistant for use in harsh marine and industrial environments
- Suitable for 6–36V system configurations with up to 10A ratings (12V)

Ideal for:
Single or multiple circuit lighting applications



Part #	1001306	1001302	1001303	1001307
Type	SPST			
Action	Off-On	Off-On	Off-On (two circuit)	Off-On
Nominal Voltage	6–36V DC	6–36V DC	6–36V DC	6–36V DC
Ratings	10A at 12V DC	10A at 12V DC	10A at 12V DC	10A at 12V DC
Termination Type	wire leads, 16 AWG, 8"	#8–32 screws	#8–32 screws	#8–32 screws



Part #	1001304	1001301	1001305
Type	SPDT		
Action	Off-On1-On2	Off-On1-On1&2	Off-On1&2-On1&3
Nominal Voltage	6–36V DC	6–36V DC	6–36V DC
Ratings	10A at 12V DC	10A at 12V DC	10A at 12V DC
Termination Type	#8–32 screws	#8–32 screws	#8–32 screws

Pull Switch











Part #	1001308
Type	SPST
Action	Off-(On)
Nominal Voltage	6–36V DC
Ratings	10A at 12V DC
Termination Type	#8–32 screws

() = Momentary

Ignition Switches

- Available in a variety of Off/On/Accessory/Ignition configurations to suit specific applications
- Suitable for 6–36V DC system configurations
- All ignition switches include 2 keys

				
Part #	1001605	1001608	1001606	1001607
Action	Off-On	Off-On	Off-Ignition-Start	Off-Ignition & Accessory-Start
Nominal Voltage	12V DC	12V DC	12V DC	12V DC
Ratings	Ignition 10A at 12V DC	5A at 12V DC	Ignition 10A, Start 5A at 12V DC	Ignition 10A, Start 5A at 12V DC
Termination Type	#8-32 screws	#8-32 screws	#8-32 screws	#8-32 screws

				
Part #	1001610	1001604	1001603	1001609
Action	Off-Ignition-Start	Off-Ignition & Accessory-Start	Accessory-Off-Ignition & Accessory-Start	Accessory-Off-Ignition & Accessory-Start
Nominal Voltage	6-36V DC	12-48V DC	12/12V DC	12V DC
Ratings	15A Ignition, 5A Start	10A at 12V DC, 5A at 24V DC, 3A at 36V DC, 2A at 48V DC	10A at 12V DC, 5A at 24V DC	Accessory 10A, Ignition 5A, Start 5A at 12V DC
Termination Type	#8-32 screws	Deutsch Connector (included)	Deutsch Connector (included)	#8-32 screws

Alarm

- A convenient way to add alarm functionality to your dash or panel
- Buzzer sounds and bright red light illuminates when voltage is present
- For use with temperature, oil pressure, and engine warning alarm kits



Part #	1002301
Family	12V
Nominal Voltage	12V DC
Termination Type	#8-32 screws
LED	● Red

Master Disconnect

- Compact lever-operated battery disconnect switch
- Rated for 175A for use in 12V DC systems
- Suitable for 6-36V DC system configurations
- Includes face plate



Part #	1001001	1001002
Action	Off-On	Off-On
Family	175A	125A
Nominal Voltage	6-36V DC	6-36V DC
Ratings	175A at 12V continuous	175A at 12V continuous
Termination Type	3/8" Brass Nut	3/8" Brass Nut

Dimmer Switches

- Easily control the brightness of incandescent bulbs from dim to bright
- Not intended for use with LED lights



Part #	1002101	1002102
Family	12V - 4A	12V - 7A
Nominal Voltage	12V DC	12V DC
Ratings	4A at 12V DC	7A at 12V DC
Termination Type	3-way connector	wire leads, 16 AWG, 2"

Kill Switch

- Ideal for adding engine-stop safety to older boats
- Available as a switch & lanyard combo, or replacement lanyard only



Part #	1001601	1001602
Family	Switch & Lanyard	Lanyard Only
Nominal Voltage	12-24V DC	—
Ratings	10A at 12-24V DC	—
Termination Type	1/4" blades	—

LED Pilot Indicator

- This 12V solid-state LED never needs replacement
- Feature bright chrome-plated body, washer and hex nut
- Polarized quick connect terminals for ease of wiring
- Available in Amber, Red, Green, and Blue

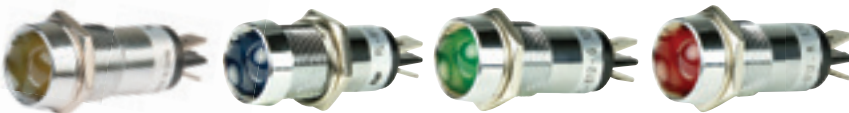

Part #	1001101	1001102	1001103	1001104
Family	12V	12V	12V	12V
Nominal Voltage	12V DC	12V DC	12V DC	12V DC
Termination Type	1/4" blades	1/4" blades	1/4" blades	1/4" blades
LED	● Amber	● Blue	● Green	● Red



POWER DISTRIBUTION PANELS

Switch Panels



64

A range of switch panels for interior and exterior use, choices with and without in-built circuit protection.

Switches



67

Switch options for interior and exterior including high quality waterproof stainless steel push buttons with LED status.

Custom Panel & Design Services

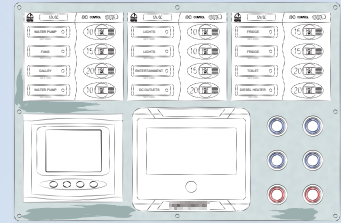

69

Custom Panels can be made to fit the needs of custom and production boat builders. For example, a panel can be made up with eight circuit breakers, four systems in operation lights plus a meter, or a panel can consist of a mixture of analog and digital meters if required.



POWER DISTRIBUTION PANELS

DC Circuit Breaker Panels



72

Off-the-shelf solution for controlling your vessel or vehicle's DC system with quality panels which include backlighting and circuit on status. Monitoring options range from basic analog metering, through to full systems in operation and tank monitoring.

AC Circuit Breaker Panels



78

Complimentary to the standard DC Panels, these AC circuit break panels cover systems ranging from four outputs through to multiple inputs and 16 output circuits. Monitoring options range from analog through to comprehensive digital meters.

Circuit Breaker Panel Labels

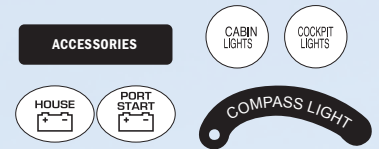

81

Standard labels sets for circuit breaker panels, switch panels and for battery.



Contour Generation II Switch Panels

The Contour Generation II Spray Proof Range offers unique styling using the latest techniques in injection molding. The switch tray is molded plastic with a rubber gasket and seal molded into the plastic. The cover is molded in a clear plastic with a rubber over-mold allowing the flexibility to operate the switches through the front of the panel while providing a clear window for label backlighting. The contour wave strip is interchangeable allowing for custom colors for OEM applications. Standard color supplied is black panel with charcoal strip.

G2 can be mounted vertically or horizontally and is available in 2-, 4- and 6-way configurations.

A joiner (CG2-JB) is available for multiple panel installations. Supplied complete with on/off switches, these can be interchanged with a variety of different switch options.

- Replaceable clip-on contour wave (customized colors available for OEMs)
- Mounting screws covered by switch cover
- Backlit LEDs
- Flexible overshoot cover allows for easy switch operation
- Ribbed gasket provides watertight seal with switch cover
- Molded gasket on panel base creates watertight seal against mounting surface
- Unique design allows labels to be read whether mounted vertically or horizontally
- Switches rated at 16A DC
- Panel supplied standard with label SET-G2-1 (labels SET-G2-2 ordered separately, page 85)



Switches	Color	Fuses	Label Set #	Part #
2	Charcoal	No	SET-G2-1	CG2-2W
2	Charcoal	1	SET-G2-1	CG2-2W-F
4	Charcoal	No	SET-G2-1	CG2-4W
4	Charcoal	2	SET-G2-1	CG2-4W-F
6	Charcoal	No	SET-G2-1	CG2-6W
6	Charcoal	3	SET-G2-1	CG2-6W-F



Spare Switches for Contour Generation II

Part #	Switch type
SW-CG1	On/Off
SW-CG2	On/Off Momentary
SW-CG3	On/Off/On
SW-CG4	Momentary On/Off/ Momentary On
SW-CG5	On/On

Related Products



Label Sets
page 85

Waterproof Series Panels

- Compact panel size
- Sprayproof inline fuse holders with fuses included
- Waterproof power receptacles (16A) in 3- and 5-way models
- Waterproof to IP56 (see inside back cover)
- Switches rated at 20A DC
- LxWxH is 3.75" x 4.25" x 2.9" (95 x 107 x 75 mm)
- Panel supplied with label LBL-WP

Part #	Color	Description
900-3WPS	charcoal	3 switches plus 12V receptacle
900-4WP	charcoal	4 switches
900-5WPUSB	charcoal	5 switches plus USB
900-5WPS	charcoal	5 switches plus 12V receptacle
900-6WP	charcoal	6 switches



900-4WP



900-5WPS



900-5WPUSB

Related Products

NAVIGATION LIGHTS

Label Sets
page 83

Micro Series Panels

- Green LED backlit labels; red when on
- Full range of text or graphic labels available; mix n' match labels and panels to suit
- Switches rated 20A DC
- 3.4" x 2.3" x 1.2" (86 x 58 x 28 mm)
- Waterproof to IP56 (see inside back cover)
- Label see LBL-MIC included; additional label sets available



900-2WPOFO



900-2WP
2 x 2-way switches



900-2WPMOM



900-SOP
2 x 10 mm LEDs showing systems in operation



900-BA
Bilge alarm and bilge pump control panel includes: 1 on/off/on switch for auto manual control; 1 warning light and alarm for high water level alarm. (Float switch ordered separately - Part # SB1-FS)

Related Products



Label Sets
page 85

Contour Switch Panels

- CSP6-PTC uses the latest in overload protection technology— Positive Temperature Coefficient
- Green LED backlit labels; red systems on indicator
- Switches rated 20A DC
- Removable cover plates conceal screws & water drain
- Label set SET-1SP included
- **CSP6** Includes six switches unfused for installation where separate fused supply is available.
- **CSP6-F** Includes six switches and three inline fuse holders with fuses behind panel.
- **CSP6-PTC** fuses are solid state resettable fuses which change to a high resistance device on over-current. The panel is supplied with 6 x 9A PTC fuses mounted internally. No more changing fuses!

Part # charcoal	Fuses	PTC	LxWxH	Label Set #
CSP6	No	No		
CSP6-F	3	No	6.25" x 4.4" x 2.5" 158 x 112 x 64 mm	SET-1SP
CSP6-PTC	No	6		



CSP6

Related Products

ACCESSORIES

Label Sets
page 83

Spare Parts for Waterproof, Micro and Contour Switch Panels



Toggle Switches

Part #	Operation
SW-32111	on/off
SW-32113	on/on
SW-32114	on/off/on
SW-32115	(on)off/momentary
SW-32120	(on)off(on) momentary
SW-32123	on/off/on double pole



Splash Proof Boot
SW-M331



12VDUSB

12VDUSBW-B

SeaLink® Deluxe Dual USB Charger Receptacles

- 12V to 24V DC input
- 5V, 2.1 amp total output
- LED power indicator light for USB
- Water resistant cover protects against dust and water

Part #	12VDUSB	black (with insulated terminals)
OEM #	12VDUSB-B	black
OEM #	12VDUSBN-B	black no LED
OEM #	12VDUSBW-B	white



12VRC

12VPG

Deluxe 12V Plug & Receptacle

Inline ATC Fuse Holder



WAFH-14

Contour Interior 1000 Series Switch Panels

The smart, economical interior option for smaller vessels. Fully modular and built with ease of access in mind.

- Removable frame conceals mounting screws
- Concealed ATC fuses accessible from front of panel; ATC fuses supplied
- 16A rocker switches
- Panels are modular and square for vertical or horizontal stacking
- LED Systems On light
- Supplied with: Spacer for accurate mounting placement, label set sheet # SET-1000
- Maximum panel load 50A



1000-VM-12V Voltmeter

1000-6W Switch Panel

Description	Part #
12V Systems	1000-VM-12V
DC Systems Monitor	1000-DCSM
AC Systems Monitor	1000-ACSM

Switches	Fuses	Voltage	Part #
6	6x 15A	12	1000-6W
6	6x 15A	24	1000-6W-24V

Now available with digital AC and DC systems monitors

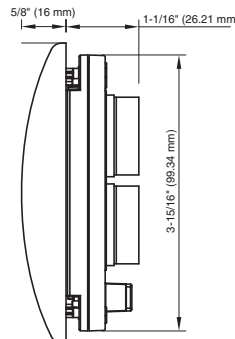
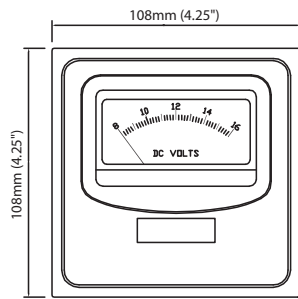
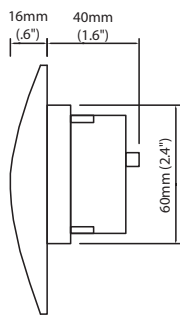

Side profile systems panel



1000-6W

Related Products



SW-RVS2 ON/OFF



Label Sets page 85

Contour 1100 Series Switches

The Contour Interior switch can be either surface or recess mounted.

The interior series is supplied standard with a three terminal on/on switch which can be used for on/off circuits or two way light installations.

For applications, eg: shower drain pumps or electric toilets, momentary switches can be interchanged into the switch plate.

Switches can be turned 90° for horizontal mounting, and all are current rated at 10A DC.

All switches include a label set.

Replacement and/or different Operational Switch

Description	Part #
On/On (On/Off)	SW-6064B3P
On/Off/On	SW-6064C3P
On/Off Spring-loaded in "on" position	SW-6064D3P



Related Products



Labels Sets page 83

Part #	1100-BK	1101-BK	1101-BK-TS
Interior/Exterior	Interior	Interior	Exterior
Single/Double	Single	Double	Double
Rated	10A	10A	20A
LxWxH	2.4" x 1.2" x 0.75" 60 x 30 x 18 mm	3.6" x 1.2" x 0.75" 91 x 30 x 18 mm	3.6" x 1.2" x 0.75" 91 x 30 x 18 mm

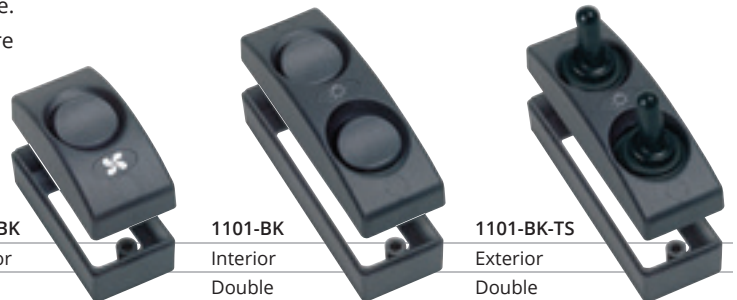

12V & 24V Push-button Switches & Buzzers with LED Ring

Push-button Switches & Buzzers are built to last with their stainless steel components and silver alloy contacts. The through panel mount switches are ideal for lighting, switch, or dash panels, with colored rings that can be wired to either display power to the system or switch back lighting. The product line includes both switches and warning buzzers with LED light rings.



buzzer

Features & Benefits:

- Maximum switch current rating 5 amps
- IP67 environmental protection switches (see inside back cover)
- IP50 environmental protection buzzers (see inside back cover)
- 80 decibel buzzer sound intensity
- Warning buzzers flash red on alarm



12V

Description	Color	Part #	OEM #
Latching On/Off	Red	80-511-0001-00	80-511-0001-01
Latching On/Off	Blue	80-511-0003-00	80-511-0003-01
Latching On/Off	Green	—	80-511-0011-01
Momentary (On)/Off	Red	80-511-0002-00	80-511-0002-01
Momentary (On)/Off	Blue	80-511-0004-00	80-511-0004-01
Momentary (On)/Off	Green	—	80-511-0012-01
Buzzer	Red	80-511-0009-00	80-511-0009-01

24V

Description	Color	Part #	OEM #
Latching On/Off	Red	80-511-0005-00	80-511-0005-01
Latching On/Off	Blue	80-511-0007-00	80-511-0007-01
Momentary (On)/Off	Red	80-511-0006-00	80-511-0006-01
Momentary (On)/Off	Blue	80-511-0008-00	80-511-0008-01
Buzzer	Red	80-511-0010-00	80-511-0010-01

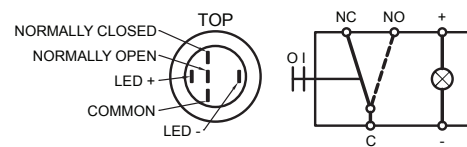
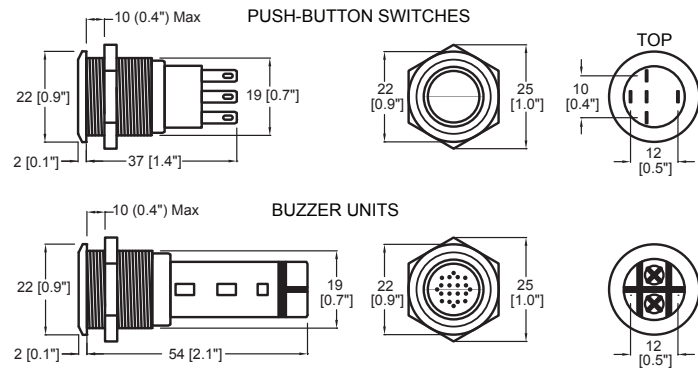

Connection Cable

This 12" (300 mm) cable simply pushes onto the back of the push button switches and features 0.8 mm² (18g) cables for switch and backlight connections that comply with ISO/ABYC. Other end is stripped wire for easy connection.



Part # 80-511-0031-00
 OEM # 80-511-0031-01

Custom Panel & Design Services

BEP offers a wide range of standard AC and DC Circuit Breaker Panels. Whether customers require some minor modification to a standard panel, a custom selection of breakers and meters, or a completely tailored circuit design and battery switch panel, BEP can deliver a solution.



Details on how to create your custom panel, see following page. ▶

Custom Panel Selection

Easy 4 Step Process

Custom Panel Selection is simple and effective. The customer will need to define which selection of Panel Sections are required for the system. Panel layout will define the relative location of each Panel Section type in a simple grid. Breaker ratings, load groups or meter sources will then need to be defined within each Panel Section.

1 Pick Panel Section Types

Breaker & Meter panels can vary between AC or DC and 110V or 230V systems. Each Panel Section holds four or six breakers per block or a single meter.

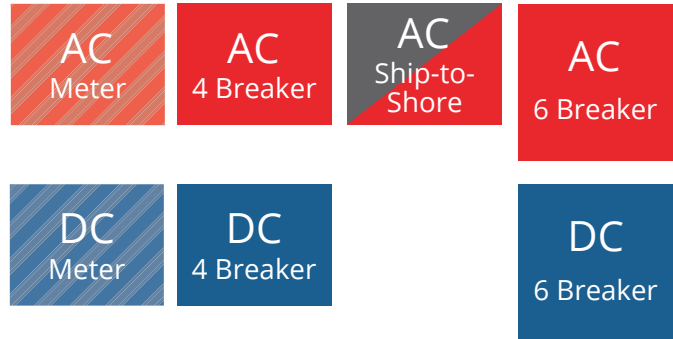

2 Panel Layout

Panel Sections can be assembled in a grid layout and will vary based on the layout and the number of Panel Section blocks required.

Blanks can be used to even up rows or columns, or can feature additional custom requirements from indicator lights to switches.

Residual Current Circuit Breaker and Overcurrent Protection (RCBO) and Ship-to-Shore slide selection can also be added.

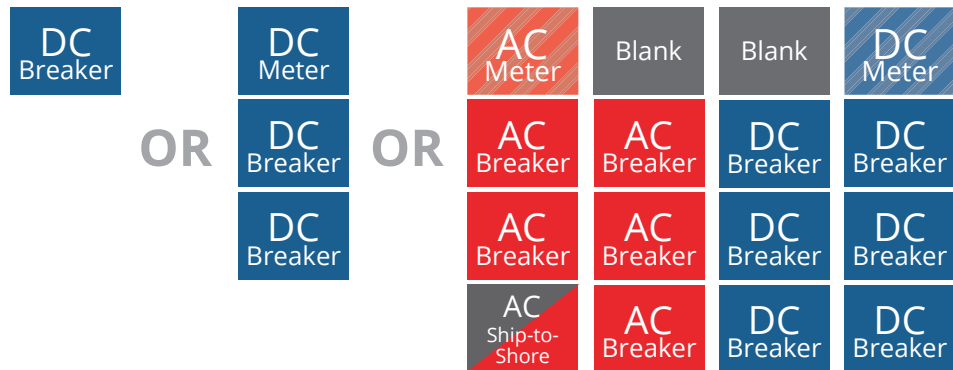

3 Define Breaker Ratings Positions & Load Groups

Each four or six breaker panel can hold any combination of required amperage ratings and source load groups.



4 Order

Contact your BEP Agent with your Panel Layout and Circuit Drawings. BEP will then confirm pricing, breaker panel drawings and estimated lead time for your consideration.

Panel Design Services

For a completely tailored product based on your needs

For specific requirements, we can develop a customized breaker and battery panel solution that will ensure your installation meets your customers' exact requirements.

Specifications & Ordering

Once you have developed a wiring diagram or illustration of the requirements for your installation, contact your BEP agent to discuss your individual requirements and specifications. A comprehensive layout and drawing will be developed, with pricing and estimated lead time to be presented for your consideration.

To help guide your design, BEP features a number of common custom requirements for consideration.

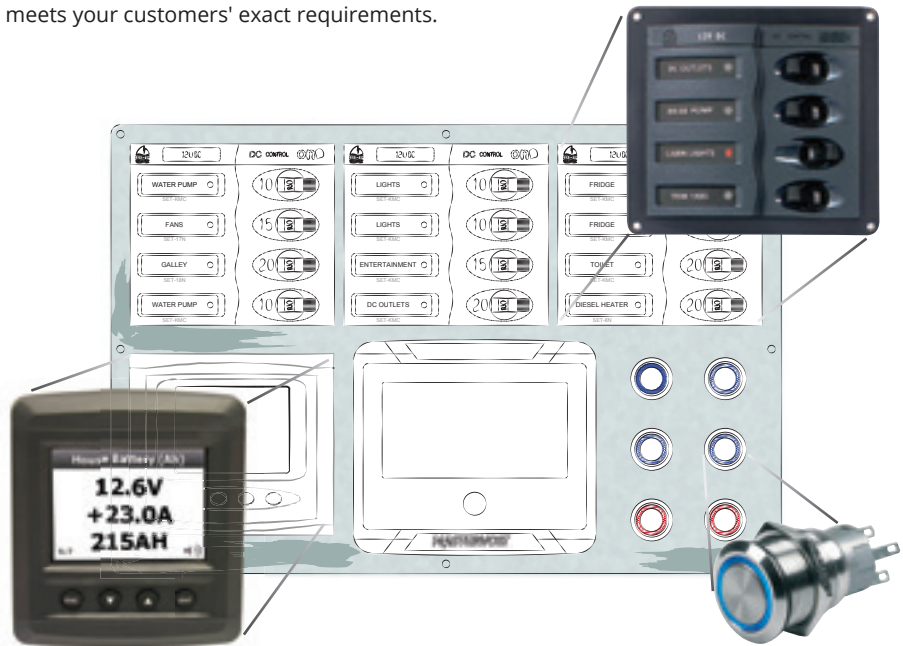

Battery Management & Circuit Breaker Panels

Large area panels can often hold a custom selection of circuit breakers, RCDs, battery switches and more. Sizes can range from small traditional sizes up to a maximum of 2 metres.



Adding a mimic panel

Mimic panels or simple indicator lights can be added to illustrate circuit activation or warnings.

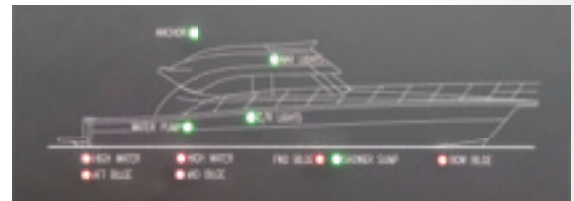

Professionally cut to shape

Panels are not always traditional and square. We have the capability to design any number of complex shapes, ideal if you have a tight or non-traditional space to work with, or you simply desire different aesthetics in your installation.



Custom switch locations graphics

Customized switch types and locations with tailored graphics, logos and labels can be supplied complete with wiring harness based on your specification ready for immediate installation.



Non-panel

Our team have a broad range of capability and can develop customised wired solutions or components for your installation.



DC Circuit Breaker Panels—No Meters

- Red systems on LED
- 12V (24V Backlighting Upgrade Kits on page 73)
- Marine grade powder coated aluminium
- ABYC standard voltage indication
- Green LED backlit labels
- Stylish clip on contour fascia
- Label set(s) and busbar supplied with panels
- Depth for mounting 2.5" (64 mm) all panels

POWER TIP

Maximum Amperage Explained

To reach the 160A maximum stated amperage rating each copper bus on rear of DC Panel requires a separate 16 mm² / 6 AWG feed cable that is attached to center of the bus bar i.e. on a 16 circuit breaker panel with a single bus the feed cable should be attached between circuit breakers #8 and #9.



Part #	900-DC	901H	901V	902NMH
Total Positions	4 Loads	8 Loads	8 Loads	12 Loads
Circuit Breakers (single pole)	1x 5A, 2x 10A, 1x 15A	2x 5A, 2x 10A, 3x 15A, 1x 20A	2x 5A, 2x 10A, 3x 15A, 1x 20A	3x 5A, 4x 10A, 4x 15A, 1x 25A
Nominal Voltage	12V*	12V*	12V*	12V*
Maximum Amperage	80A	160A	160A	100A
HxWx2.5" HxWx65 mm	4.5" x 5" 115 x 127 mm	4.5" x 9.75" 115 x 239 mm	7.9" x 5" 200 x 127 mm	4.5" x 13.9" 115 x 351 mm
Neg Bus	6-way	6-way	6-way	6-way
Label Sheet	1	1	1	1

*24V Backlighting Upgrade Kits on page 73.

Related Products

ACCESSORIES

Label Sets
page 81-82



Part #	902NMV	904NM	904NMH
Total Positions	12 Loads	16 Loads	16 Loads
Circuit Breakers (single pole)	3x 5A, 4x 10A, 4x 15A, 1x 25A	4x 5A, 5x 10A, 5x 15A, 1x 20A, 1x 25A	4x 5A, 5x 10A, 5x 15A, 1x 20A, 1x 25A
Nominal Voltage	12V*	12V*	12V*
Maximum Amperage	160A	160A per bus	80A per bus
HxWx2.5" HxWx65 mm	11.25" x 5" 285 x 127 mm	7.9" x 9.75" 200 x 239 mm	4.5" x 18.25" 115 x 463 mm
Neg Bus	6-way	12-way	12-way
Label Sheet	1	1	1

*24V Backlighting Upgrade Kits on page 73.

Cutout size - 3/8" (10 mm) inside all external edges.

For more information on circuit breaker panels go to bepmarine.com



Part #	904NMV	905NM	905NMV
Total Positions	16 Loads	24 Loads	24 Loads
Circuit Breakers (single pole)	3x 5A, 4x 10A, 4x 15A, 1x 25A	5x 5A, 8x 10A, 8x 15A, 1x 20A, 1x 25A, 1x 30A	5x 5A, 8x 10A, 8x 15A, 1x 20A, 1x 25A, 1x 30A
Nominal Voltage	12V*	12V*	12V*
Maximum Amperage	160A	160A per bus	160A per bus
HxWx2.5" HxWx65 mm	14.6" x 5" 370 x 127 mm	7.9" x 13.9" 200 x 351 mm	11.25" x 9.75" 285 x 239 mm
Neg Bus	6-way	12-way	12-way
Label Sheet	1	1-3	1-3

*24V Backlighting Upgrade Kits below.



Part #	906NMH	906NMV	NC36NM
Total Positions	32 Loads	32 Loads	36 Loads
Circuit Breakers (single pole)	7x 5A, 11x 10A, 11x 15A, 1x 20A, 1x 25A, 1x 30A	7x 5A, 11x 10A, 11x 15A, 1x 20A, 1x 25A, 1x 30A	8x 5A, 12x 10A, 12x 15A, 2x 20A, 1x 25A, 1x 30A
Nominal Voltage	12V*	12V*	12V*
Maximum Amperage	160A per bus	160A per bus	160A per bus
HxWx2.5" HxWx65 mm	7.9" x 18.25" 200 x 463 mm	14.6" x 9.75" 370 x 239 mm	11.25" x 13.9" 285 x 351 mm
Neg Bus	24-way	24-way	24-way
Label Sheet	1-4	1-4	1-4, 6

*24V Backlighting Upgrade Kits below.

24V Backlighting Upgrade Kits

For changing 12V panels to 24V backlighting.

# of Circuits	Part #	# of Circuits	Part #	# of Circuits	Part #
4-way	RES-4WAY	20-way	RES-20WAY	36-way	RES-36WAY
8-way	RES-8WAY	24-way	RES-24WAY	44-way	RES-44WAY
12-way	RES-12WAY	28-way	RES-28WAY		
16-way	RES-16WAY	32-way	RES-32WAY		

DC Circuit Breaker Panels—With Digital/Analog Monitoring

- All panels are available with either Analog or Digital meters
- 12V (24V Backlighting Upgrade Kits on page 73)
- Label set(s) and busbar supplied with panels
- Depth for mounting 2.5" (64 mm) all panels

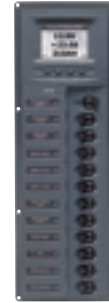

Part #	900V-DCSM	901V-DCSM	902-DCSM	902V-DCSM
Meter	digital	digital	digital	digital
Total Positions	4 Loads	8 Loads	12 Loads	12 Loads
Circuit Breakers (single pole)	1x 5A, 2x 10A, 1x 15A	2x 5A, 2x 10A, 3x 15A, 1x 20A	3x 5A, 4x 10A, 4x 15A, 1x 25A	3x 5A, 4x 10A, 4x 15A, 1x 25A
Nominal Voltage	12V*	12V*	12V*	12V*
Maximum Amperage	80A	160A	160A/80A buses	160A
HxWx2.5" HxWx65 mm	7.9" x 5" 200 x 127 mm	11.6" x 5" 295 x 127 mm	7.9" x 9.75" 200 x 239 mm	15" x 5" 380 x 127 mm
Neg Bus	6-way	6-way	6-way	6-way
Label Sheet	1	1	1	1

*24V Backlighting Upgrade Kits on page 73.



Part #	904-DCSM	903-DCSM	905-DCSM	905V-DCSM
Meter	digital	digital	digital	digital
Total Positions	16 Loads	20 Loads	24 Loads	24 Loads
Circuit Breakers (single pole)	4x 5A, 5x 10A, 5x 15A, 1x 20A, 1x 25A	5x 5A, 6x 10A, 7x 15A, 1x 20A, 1x 30A	5x 5A, 8x 10A, 8x 15A, 1x 20A, 1x 25A, 1x 30A	5x 5A, 8x 10A, 8x 15A, 1x 20A, 1x 25A, 1x 30A
Nominal Voltage	12V*	12V*	12V*	12V*
Maximum Amperage	160A per bus	160A/80A/160A buses	160A per bus	160A per bus
HxWx2.5" HxWx65 mm	11.6" x 9.75" 295 x 239 mm	7.9" x 9.75" 200 x 351 mm	11.6" x 13.9" 295 x 351 mm	15" x 9.75" 380 x 239 mm
Neg Bus	12-way	12-way	12-way	12-way
Label Sheet	1-2	1-3	1-3	1-3

*24V Backlighting Upgrade Kits on page 73.



Part #	906-DCSM	906V-DCSM	907-DCSM
Meter	digital	digital	digital
Total Positions	32 Loads	32 Loads	48 Loads
Circuit Breakers (single pole)	7x 5A, 11x 10A, 11x 15A, 1x 20A, 1x 25A, 1x 30A	7x 5A, 11x 10A, 11x 15A, 1x 20A, 1x 25A, 1x 30A	12x 5A, 15x 10A, 15x 15A, 3x 20A, 1x 25A, 2x 30A
Nominal Voltage	12V*	12V*	12V*
Maximum Amperage	160A per bus	160A per bus	160A per bus
HxWx2.5" HxWx65 mm	11.6" x 18.25" 295 x 463 mm	18" x 9.75" 455 x 239 mm	15" x 18.25" 380 x 463 mm
Neg Bus	24-way	24-way	2 x 24-way
Label Sheet	1-4	1-4	1-5

All analog panels supplied with one shunt, extra shunts ordered separately. Digital panels supplied with 450A-50mV shunt. Cutout size - 10 mm (3/8") inside all external edges.

All panels available in 12V or 24V configuration. All part numbers shown are 12V backlighting. Order upgrade kits to suit number of breakers in panel. See page 73 for upgrade part number.

For more information on circuit breaker panels go to bepmarine.com

Related Products



Ammeters
page 95

Related Products



Label Sets
page 81-82

Cruiser Series DC Branch Circuit Breaker Panels

- 12V / 24V
- Mimic panel for quick reference of systems in operation
- Blank space for addition of extra meter
- Digital or analog readouts
- Depth for mounting 2.5" (64 mm) all panels



Part #	NC32Y-DCSM	NC36L-DCSM
Meter	digital	digital
Total Positions	32 Loads	36 Loads
Circuit Breakers (single pole)	7x 5A, 11x 10A, 11x 15A, 1x 20A, 1x 25A, 1x 30A	8x 5A, 12x 10A, 12x 15A, 2x 20A, 1x 25A, 1x 30A
Nominal Voltage	12V or 24V*	12V or 24V*
Maximum Amperage	160A per bus	160A per bus
HxWx2.5"	15" x 13.9"	15" x 13.9"
HxWx65 mm	380 x 351 mm	380 x 351 mm
Neg Bus	24-way	24-way
Label Sheet	1-4, 6	1-4, 6

Related Products

ACCESSORIES

Label Sets
page 81-82

All analog panels supplied with one shunt, extra shunts ordered separately. Digital panels supplied with 450A - 50mV shunt. Cutout size - 3/8" (10 mm) inside all external edges.

*All panels available in 12V or 24V configuration. If 24V is required, please specify when ordering by adding -24V to part number.

Double Pole Panels

- Double pole panels available in all panel sizes.
- Double pole CBs use twice the space of single pole breakers; an 8-load single pole panel will become 4-load when using double pole circuit breakers
- AC or DC versions available
- Single toggle



904NM-DP

Millennium Series DC Branch Circuit Breaker Panels

- 12V / 24V
- Compact sizing
- Battery monitoring using BEP multifunction meter (voltage on 3 battery banks, charge, discharge amps and amp-hours remaining on main battery bank)
- Depth for mounting 2.5" (64 mm) all panels



Part #	M28-DCSM	M32-DCSM	M44-DCSM
Meter	digital	digital	digital
Total Positions	28 Loads	32 Loads	44 Loads
Circuit Breakers (single pole)	8x 5A, 8x 10A, 8x 15A, 2x 20A, 2x 30A	7x 5A, 11x 10A, 11x 15A, 1x 20A, 1x 25A, 1x 30A	10x 5A, 14x 10A, 14x 15A, 3x 20A, 1x 25A, 2x 30A
Nominal Voltage	12V or 24V*	12V or 24V*	12V or 24V*
Maximum Amperage	160A per bus	160A per bus	160A per bus
HxWx2.5" HxWx65 mm	14.6" x 9.75" 370 x 239 mm	11.25" x 13.9" 285 x 351 mm	14.6" x 13.9" 370 x 351 mm
Neg Bus	24-way	24-way	24-way
Label Sheet	1-4	1-4, 6	1-4, 6



Part #	M44H-DCSM	M56-DCSM
Meter	digital	digital
Total Positions	44 Loads	56 Loads
Circuit Breakers (single pole)	10x 5A, 14x 10A, 14x 15A, 3x 20A, 1x 25A, 2x 30A	12x 5A, 18x 10A, 18x 15A, 4x 20A, 2x 25A, 2x 30A
Nominal Voltage	12V or 24V*	12V or 24V*
Maximum Amperage	160A per bus	160A per bus
HxWx2.5" HxWx65 mm	11.25" x 18.25" 285 x 463 mm	18" x 13.9" 455 x 351 mm
Neg Bus	24-way	2x 24-way
Label Sheet	1-4, 6	1-4, 6

Related Products

ACCESSORIES

Label Sets
page 81-82

AC Main Circuit Breaker Panels—No Meters

- Ideal for AC shore power installations and on board inverter installations
- For standard twin input systems, eg: one shore power and one genset input
- Depth for mounting 2.5" (64 mm) all panels



Part #	900-ACM2W-110V	900-ACM2W	900-ACM6W-110V	900-ACM6W	900-AC1-110V	900-AC1	900-ACCH-110V	900-ACCH
Nominal Voltage	110V AC	230V AC	110V AC	230V AC	110V AC	230V AC	110V AC	230V AC
Total Positions	2 Loads + 1 Input		6 Loads + 1 Input		4 Loads + 2 Inputs		2 Input Selector	
Circuit Breakers (single + double pole)	2x 15A + 1x 30A	2x 10A + 1x 20A	3x 15A, 2x 20A, 1x 25A + 1x 30A	2x 10A, 3x 15A, 1x 20A + 1x 20A	2x 15A, 2x 20A + 2x 30A	2x 10A, 2x 15A + 2x 20A	2x 30A	2x 15A
Maximum Amperage	30A	20A	30A	20A	30A	20A	30A	15A
HxWx2.5" HxWx65 mm	4.5" x 5" 115 x 127 mm		7.9" x 5" 200 x 127 mm		4.5" x 9.4" 115 x 239 mm		7.9" x 5" 200 x 127 mm	
Neg Bus	IS-6MM-2		IS-6MM-2		IS-6MM-2		IS-6MM-2	
Label Sheet	5		5		5		5	



Reverse Polarity Auto Trip Breaker

Now standard on all 230V, 50Hz panels (Euro and Asia-Pacific). This will automatically trip when it detects reverse polarity.

See page 51 for more details

AC Main Circuit Breaker Panels—Digital

- All supplied with transducers
- Reverse polarity indicator
- Double pole mains input CBs with side lockout
- Digital meter shows volts, amps and frequency
- LED wired to indicate live panel with mains breaker either on or off
- AC source selector ensures no cross over between AC inputs (ship or shore power)
- AC voltage/frequency label to comply with ABYC Standards



Part #	900-AC1H-ACSM	900-ACM6V-ACSM-110	900-ACM6V-ACSM	900-AC2H-ACSM-110	900-AC2H-ACSM	
Nominal Voltage	230V AC	110V AC	230V AC	110V AC	230V AC	
Meter	digital	digital	digital	digital	digital	
Total Positions	4 Loads + 2 Inputs		6 Loads + 1 Input		8 Loads + 2 Inputs	
Circuit Breakers (single + double pole)	2x 10A, 2x 15A + 2x 20A	2x 10A, 3x 15A, 1x 20A + 1x 20A	2x 10A, 3x 15A, + 1x 20A	2x 10A, 3x 15A, 2x 20A, 1x 25A + 1x 30A, 1x 50A"	1x 5A, 3x 10A, 3x 15A, 1x 20A + 1x 20A, 1x 30A"	
Maximum Amperage	20A	20A	20A	50A	30A	
HxWx2.5" HxWx65 mm	4.5" x 13.8" 115 x 351 mm		11.6" x 5" 295 x 127 mm		7.9" x 9.75" 200 x 239 mm	
Neg Bus	IS-6MM-2		2x6-way		2x6-way	
Label Sheet	5		5		5	



Part #	900-AC2H-ACSM-110	900-AC2H-ACSM	900-AC2V-ACSM-110	900-AC2V-ACSM
Nominal Voltage	110V AC	230V AC	110V AC	230V AC
Meter	digital	digital	digital	digital
Total Positions	8 Loads + 2 Inputs		8 Loads + 2 Inputs	
Circuit Breakers (single + double pole)	2x 10A, 3x 15A, 2x 20A, 1x 25A + 1x 30A, 1x 50A	1x 5A, 3x 10A, 3x 15A, 1x 20A + 1x 20A, 1x 30A	1x 5A, 2x 10A, 3x 15A, 2x 20A, 1x 25A + 1x 30A, 1x 50A	1x 5A, 3x 10A, 3x 15A, 1x 20A + 1x 20A, 1x 30A
Maximum Amperage	50A	30A	50A	30A
HxWx2.5" HxWx65 mm	7.9" x 9.75" 200 x 239 mm		15" x 5" 380 x 127 mm	
Neg Bus	2x6-way		2x6-way	
Label Sheet	5		5	



Part #	900-AC3-ACSM-110	900-AC3-ACSM	900-AC4-ACSM-110	900-AC4-ACSM
Nominal Voltage	110V AC	230V AC	110V AC	230V AC
Meter	digital	digital	digital	digital
Total Positions	12 Loads + 2 Inputs		16 Loads + 2 Inputs	
Circuit Breakers (single + double pole)	3x 10A, 4x 15A, 3x 20A, 1x 25A, 1x 30A + 1x 30A, 1x 50A	1x 5A, 4x 10A, 5x 15A, 1x 20A, 1x 25A + 1x 20A, 1x 30A	5x 10A, 7x 15A, 2x 20A, 1x 25A, 1x 30A + 1x 30A, 1x 80A	1x 5A, 5x 10A, 7x 15A, 2x 20A, 1x 25A + 1x 20A, 1x 50A
Maximum Amperage	50A	30A	80A	50A
HxWx2.5" HxWx65 mm	7.9" x 13.9" 200 x 351 mm		7.9" x 13.9" 200 x 351 mm	
Neg Bus	2x12-way		2x12-way	
Label Sheet	5		5	

Cutout size – 3/8" (10 mm) inside all external edges. All panels available in 12V or 24V backlighting configuration.

Related Products

ACCESSORIES

Label Sets
page 81-82

Back Panel Covers

- Designed to insulate exposed rear terminals
- Flame retardant PVC in two styles
- Flange Mount: for access to control panel back when mounted in place. Attaches to the rear of the same mounting surface as the panel.
- Panel Mount: for access only when panel is removed. Supplied with mounting pedestals.



BC-PM1



BC-FM1



BC-FM2



BC-PM2

Part #	Mount type	Cover Description	HxWxD	HxWxD
BC-FM1	Flange	1 column 8-12 CBs + meter	15" x 5" x 3.5"	380 x 127 x 90 mm
BC-FM2	Flange	2 column 8-12 CBs + meter	15" x 9.4" x 3.5"	380 x 239 x 90 mm
BC-FM3	Flange	1 column 8-12 CBs	11.2" x 5" x 3.5"	285 x 127 x 90 mm
BC-FM4	Flange	2 column 8-12 CBs	11.2" x 9.4" x 3.5"	285 x 239 x 90 mm
BC-PM1	Panel	1 column 8-12 CBs + meter	14.2" x 4.2" x 3.5"	360 x 107 x 90 mm
BC-PM2	Panel	2 column 8-12 CBs + meter	14.2" x 8.6" x 3.5"	360 x 219 x 90 mm



Labels–Circuit Breaker Panels

ACCESSORIES	BAIT TANK PUMP	12V OUTLETS	AFT LIGHTS	AC MAINS	AC MAINS
SET-1N	SET-2N	SET-3N	SET-4N	SET-5N	SET-6N
ACCESSORIES	BAIT TANK PUMP	12V OUTLETS	AFT LIGHTS	AC MAINS	AC MAINS
ANCHOR LIGHT	BILGE PUMP AFT	24V OUTLETS	BEDROOM/CONVERTER	AC OUTLETS	ACCESSORIES
AUTO PILOT	BILGE PUMP FORWARD	AFT DECK LIGHT	DAVIT WINCH	AC OUTLETS	ANCHOR WASH
BILGE PUMP	BILGE PUMP MID	BILGE AUTO MAN.	ENGINE ALTERNATOR	AIR CONDITIONING	AUTOMATIC
CABIN LIGHTS	BILGE PUMP PORT	BOW LIGHTS	FIRE SYSTEM	BATTERY CHARGER	AUTOPILOT
CABIN LIGHTS	BILGE PUMP STARBOARD	DOCKING LIGHTS	FISH FINDER	COOK TOP	AUXILIARY
COCKPIT LIGHTS	BLOWER	EMERGENCY PARALLEL	FISHING LIGHT	DISHWASHER	BILGE AUTO MANUAL
COMPASS LIGHTS	BOARDING LIGHT	ENGINE ALARM	GALLEY/BATH	DIVE COMPRESSOR	BILGE LIGHTS
DC OUTLETS	CABIN LIGHTS AFT	ENGINE BLOWERS	HOUSE ALTERNATOR	DRYER	BOOM FURL
DEPTHSOUNDER	CABIN LIGHTS FWD	EXTRACTION FAN	INTERCOM	FREQUENCY	BRIDGE LIGHTS
FREEZER	CABIN LIGHTS MID	FLOOD LIGHTS	LOAD	GENSET	BURGLAR ALARM
FRESHWATER PUMP	CABIN LIGHTS PORT	FORE DECK LIGHT	LOCKER LIGHT	HEATER	CABIN FAN
GPS	CABIN LIGHTS STARBOARD	GALLEY LT	MID WIPER	HOTWATER CYLINDER	CB RADIO
INSTRUMENTS	DECK WASH PUMP	GENERATOR LIGHTS	MID LIGHTS	ICE MAKER	CELL PHONE
LPG CONTROL	ELECTRIC TOILET	HOLDING TANK PUMP	MIZZEN SPREADER LIGHT	INVERTER	COMPUTER
MAST LIGHT	ENGINE ROOM LIGHTS	HOUSE BATTERIES	PLOTTER	INVERTER OUTLETS	DC MAINS
NAVIGATION LIGHTS	FRIDGE	LAZERETTE LIGHT	PORT WIPER	MICROWAVE	FUEL TRANSFER
SALTWATER PUMP	HORN	PORT	PREHEAT	OVEN	GALLEY FAN
SHOWER DRAIN PUMP	NAV LT'S PORT	RADIO BATTERY	SOLE LIGHT	REFRIGERATION	HATCH CONTROLS
SPARE	NAV LIGHTS STARBOARD	SEARCH LIGHT	HEATER FANS	REVERSE POLARITY	HYDRAULICS
SPOTLIGHT	PANEL LIGHTS	STARBOARD	STARBOARD WIPER	SHIPS POWER	LOUD HAILER
SPREADER LIGHT	RADAR	START BATTERIES	SUB MAIN	SHORE POWER	MACERATOR
STEAMING LIGHT	SALOON LIGHTS	STEP LIGHT	SUMP PUMP	TRASH COMPACTOR	MANUAL
STEREO	SSB	STROBE LIGHT	TANK ROOM LIGHTS	TV	NIGHT LIGHTS
TRIM TABS	START	TOILET LT	TOILET PUMP	VIDEO	PELMET LIGHTS
VHF	STERN LIGHT	WEATHER FAX	TOWING LIGHT	WASHING MACHINE	SOLAR PANEL
WINCH	STOP	WINDEX LIGHT	TV/STEREO	WASTE MASTER	STOVE
WIPER	TRI LIGHT	WINDOW WASHERS	WALVAC	WATER MAKER	TV ANTENNA

AFT PEAK LIGHT	ANCHOR LIGHT	BOILER/HEATER	AIR COMPRESSOR	24-12V REDUCER	ANCOR LIGHT	AC OUTLETS GALLEY
SET-7N	SET-8N	SET-9N	SET-10N	SET-12N	SET-A	SET-B
AFT PEAK LIGHT	ANCHOR LIGHT	BOILER / HEATER	AIR COMPRESSOR	24-12V REDUCER	ANCHOR LIGHT	AC OUTLETS GALLEY
DECK FLOOD LIGHTS FWD	BARAGRAPH POWER	BOW THRUSTER	AIR CON GALLEY	AERATOR	CABIN LIGHTS	AC OUTLETS PORT
DECK FLOOD LIGHTS AFT	CABIN FANS	DC/DC CONVERTER	AIR CON GUEST ROOM	BALLAST AFT	CABIN LIGHTS	AC OUTLETS STBD
DECK LIGHTS	CABIN FANS FWD	DECK LIGHTS FORWARD	AIR CON MASTER STATE	BALLAST CONTROL	DC MAINS	APPLIANCES
DECK LIGHTS PORT	CABIN FANS AFT	DECK LIGHTS AFT	AIR CON PILOT HOUSE	BALLAST FWD	DISCHARGE	BAR-B-QUE
DECK LIGHTS STARBOARD	COURTESY LTS	DECK LIGHTS MID	AIR CON SALON	BLACK TANK AFT	DISCHARGE	BILGE PUMP AUTO/MANUAL
DECK LIGHTS FORWARD	COURTESY LTS FWD	DECK LIGHTS UPPER	AIR CON SALOON	BLACK TANK FWD	DISCHARGE	BLACK WATER PUMP
DECK LIGHTS AFT	COURTESY LTS MID	DEFROSTER	AIR CON STATE ROOM	BLACK WATER PUMP	ELECTRONICS	CHART LIGHT
FISHING LIGHTS	COURTESY LTS AFT	GALLEY LIGHTS	AIR CON V-BERTH	BOOM LIGHT	ELECTRONICS	DECK LIGHTS
FISHING LIGHTS WHITE	DIESEL HEATER	GREY WATER PUMP	AIR CONDITIONING	BRIDGE LIGHTS	FRIDGE	ENGINE ALT
FISHING LIGHTS RED	FIRE SYSTEM	GUEST STATE LIGHTS	AIR CONDITIONING 1	BRIDGE SUPPLY	HELM SUPPLY	ELECTRIC TOILET
FISHING LIGHTS GREEN	FUEL PUMP	HEAD PUMP 1	AIR CONDITIONING 2	DINING LIGHTS	INVERTER	ENGINE ROOM BILGE PUMP
FISH ROOM LIGHTS	HAILER	HEAD PUMP 2	AIR CONDITIONING 3	FIRE ALARM	MACERATOR	GALLERY FRIDGE
FISH ROOM PUMP	LECTRASAN	MASTER STATE LIGHTS	CENTRAL VACUUM	FLOW ALARM	MACERATOR	GAS DETECTOR
FORE DECK LIGHT	LECTRASAN FWD	NAV LIGHTS	CHARGER GENERATOR	INTERIOR LIGHTS	OVEN	GENSET
FOCSLE LIGHT	LECTRASAN STBD	OIL PUMP	CHARGER HOUSE	LUFF LIGHT	PORT ENGINE CONTROL	HEATER
MAST FLOOD LIGHTS FWD	PORT ENGINE CONTROLS	PILOT HOUSE LIGHTS	CHARGER INVERTER	MODEM	PORT ENGINE CONTROL	INSTRUMENT LIGHTS
MAST FLOOD LIGHTS AFT	PORT IGNITION	SALOON LIGHTS	COMPACTOR	NAV AREA FAN	PUMP	LIGHTS
NET RECORDER	PORT IGNITION	SEARCH LIGHT	ENGINE ROOM FANS	OUTLETS AFT	REFRIDGERATION	PORT LIGHTS
NOT UNDER COMMAND	SAT COM	SPARE	HOT CIRC PUMP	OUTLETS FWD	STBD ENGINE CONTROL	RADIO
NUC LIGHTS	SHOWER LIGHT	SPARE	ICE MAKER LOWER	OUTLETS MID	STBD ENGINE CONTROL	READING LIGHT
PLOTTER	SALOON LIGHTS	STEREO	ICE MAKER UPPER	OUTLETS PORT	<STOP START> GENSET	SHOWER SUMP PUMP
PORT FLOOD LIGHTS	SPARE	TRIM TAB CONTROL	OUTLETS ENGINE ROOM	OUTLETS STBD	STOVE	STBD LIGHTS
SHOWER LIGHTS	SPARE	V-BERTH LIGHTS	OUTLETS EXTERNAL	PORT ENGINE	TOILET	STEREO
STBD FLOOD LIGHTS	STABILIZER	VHF LOWER	OUTLETS GALLEY	STBD ENGINE	WASHER/DRYER	TV
TOILET FAN	STBD ENGINE CONTROLS	VHF UPPER	OUTLETS LOWER DECK	STEP LIGHTS	WATER HEATER	UNDER FLOOR LIGHTS
TOILET LIGHT	STBD IGNITION	WASH DOWN PUMP	OUTLETS UPPER DECK	STROBE	12V BATTERY CHARGER	VHF
WINCH FLOOD LIGHTS	TOILET LIGHT	WINDLASS	WATER HEATER	RIDING LIGHT	24V BATTERY CHARGER	WIPER

AFT BILGE ALARM

SET-13N

AFT BILGE ALARM
BILGE ALARM
BILGE ALARM TEST
BILGE AUTO
BILGE LIGHTS
BILGE MANUAL
BILGE PUMP AUTO/
MANUAL
FWD BILGE ALARM
HIGH WATER ALARM
MID BILGE ALARM
PORT AFT BILGE ALARM
PORT AFT BILGE AUTO
PORT AFT BILGE MANUAL
PORT FWD BILGE ALARM
PORT FWD BILGE AUTO
PORT FWD BILGE MANUAL
PORT MID BILGE ALARM
PORT MID BILGE AUTO
PORT MID BILGE MANUAL
STBD AFT BILGE ALARM
STBD AFT BILGE AUTO
STBD AFT BILGE MANUAL
STBD FWD BILGE ALARM
STBD FWD BILGE AUTO
STBD FWD BILGE MANUAL
STBD MID BILGE ALARM
STBD MID BILGE AUTO
STBD MID BILGE MANUAL

210KHZ TX

SET-14N

210KHZ TX
33KHZ TX
AFT HOLD LIGHT
COCKPIT FREEZER
ENGINE CONTROLS
FRIDGE/FREEZER
FIRE PUMP
FLUXGATE COMPASS
FLYBRIDGE FREEZER
FUEL GAUGE
FUEL TRANSFER PORT
FUEL TRANSFER STBD
FWD HOLD LIGHT
GANTRY LIGHTS
HOLDING TANK PORT
HOLDING TANK STBD
MASTHEAD LIGHT
PILOT LIGHT RED
PILOT LIGHT WHITE
PORT FUEL FILTER
RUDDER INDICATOR
STBD FUEL FILTER
STEERING
TOILET AFT
TOILET FWD
TOWING LIGHT AMBER
TOWING LIGHT WHITE
TUNA TUBES

12V OUTLETS
FLYBRIDGE

SET-15N

12V OUTLET FLYBRIDGE
ARCH LIGHTS
BILGE PUMP CLUTCH
CABIN HEATER
COMPASS
DRY HEAD PUMP
DEMISTER
ENGINE CLUTCH PUMP
FLYBRIDGE HATCH
FLYBRIDGE WIPERS
FREEZER CLUTCH
FWD STATEROOM LIGHTS
GREYWATER PUMP 1
GREYWATER PUMP 2
GUEST CABIN STEREO
INMARSAT
INSTRUMENT LIGHTS
INSTRUMENTS
FLYBRIDGE
INSTRUMENTS
PILOTHOUSE
MASTER HEAD LIGHTS
NAV AREA LIGHTS
OVERHEAD LIGHTS
OVERHEAD SALOON
LIGHTS
SALOON WIPERS
SECURITY SYSTEM
UNDERFLOOR LIGHTS
24V DC MAINS
BOW BILGE HIGH WATER

AC OUTLETS AFT

SET-16N

AC OUTLETS AFT
AC OUTLETS AFT CABIN
AC OUTLETS COCKPIT
AC OUTLETS DECK
AC OUTLETS FWD
AC OUTLETS FWD CABIN
AC OUTLETS GALLEY
AC OUTLETS GUEST CABIN
AC OUTLETS MID
AC OUTLETS PORT
AC OUTLETS SALON
AC OUTLETS SALOON
AC OUTLETS STATEROOMS
AC OUTLETS STBD
AC OUTLETS WHEELHOUSE
AIRCON AFT
AIRCON AFT DECK
AIRCON CABIN
AIRCON FWD
AIRCON FWD DECK
AIRCON HELM
AIRCON PUMP
AIRCON PORT
AIRCON STBD
AIRHANDLER FWD
STATEROOM
AIRHANDLER MSTR
STATEROOM
AIRHANDLER PILOTHOUSE
AIRHANDLER SALOON

24 HOUR CIRCUITS

SET-17N

24 HOUR CIRCUITS
AFT BILGE PUMP
AUTO / MAN
AFT HEAD
ALARM MUTE
DEPTH / SPEED
ELECTRONICS
ENGINE ALARM
FANS
FWD BILGE PUMP
AUTO / MAN
FWD HEAD
GALLEY / HEAD VENT
GALLEY FRIDGE
GAS STOVE
GAUGES
HEAD PUMP
LEVEL INDICATOR
LIGHTS
MID BILGE PUMP
AUTO / MAN
NAV & INST LIGHTS
OIL PRESSURE
PT ENGINE
PT ENGINE START / STOP
STBD ENGINE
STBD ENGINE START / STOP
SUM LOG
SYNCHRONIZER
WATER TEMP
WINDSHIELD

27 MEG

SET-18N

27 MEG
AFT HOLDING TANK
AFT WATER HEATER
CABIN OUTLETS
COCKPIT FRIDGE
DC MAINS 1
DC MAINS 2
DEHUMIDIFIER
DVD
ENGINE BLOWER
ENTERTAINMENT
ENGINE ROOM OUTLETS
ENTERTAINMENT
FLYBRIDGE MAIN
FWD HOLDING TANK
FWD WATER HEATER
GALLEY
GAS SOLENOID
GENERATOR
GFCI OUTLET
HATCH LIFTER
HELM MAIN
HOUR METER
LAUNDRY
LPG/COOKTOP
NAVIGATION
RANGE
TV /DVD
UHF

12V BATTERY CHARGER

SET-19N

12V BATTERY CHARGER
24HR BILGE PUMP
24V BATTERY CHARGER
12V BATTERY CHARGER
BILGE PUMP PORT FWD
BILGE PUMP PORT MID
BILGE PUMP STBD AFT
BILGE PUMP STBD FWD
BILGE PUMP STBD MID
BOARDING PLATFORM
BULWARK LIGHTS
BUNK LIGHTS
CABLE MASTER
DESALINATOR
DISHWASHER
ELECTRIC WINDOWS
ENGINE CONTROLS
MACERATOR
OIL PUMP
PITCH CONTROL
PORT AIR CON
PORT ENGINE
SONAR
STOREROOM LIGHTS
SPA
STBD AIR CON
STBD ENGINE
TV

12V AUX HORN

SET-20N

12V AUX HORN
AFT FRIDGE
ALTERNATOR
ANCHOR WINCH
BATHROOM FAN
BATHROOM OUTLETS
BRIDGE SUPPLY
DOCKING LIGHTS
ENGINE ROOM BILGE ALARM
FAX
FISH FINDER
HOLDING TANK GAUGE
ICEMAKER
INVERTER/CHARGER
LAKE WATER
MASTER HEAD
RCD
RESET
SALON LIGHTS
SHAVER OUTLETS
SOUNDER
SPEED
SUM LOG
TOILET PORT
TOILET STBD
TV LIFT
WIND INSTRUMENTS

BOILER/HEATER

SET-22N

ALARMS
CCTV
COCKPIT FRIDGE
COMMUNICATIONS
CONTROL MAX 2.0
DECK LIGHTS
EARTH LEAKAGE LIGHTS
EMERGENCY PARALLEL
ENGINE ROOM MAIN
EQUIPMENT ROOM
FLYBRIDGE LIGHTS
FRESH WATER PUMP PORT
FRESH WATER PUMP STBD
GENSET START
GENSET STOP
GRILL
HEAD/GALLEY VENT
HF RADIO
IGNITION START
MID HOLD LIGHTS
RADIO LIGHT
RADIOS
REFRIGERATOR
REVERSE POLARITY TEST
UHF RADIO
VHF RADIO
WHEELHOUSE LIGHTS
WINE COOLER

AIR CON
FLYBRIDGE

SET-23N

AIR CON FLYBRIDGE
AIR CON FWD
AIR CON PORT
AIR CON STBD
BERTH LIGHTS
BLOWER
CABIN LIGHTS MAIN
COOLING PUMP 1
COOLING PUMP 2
DISCHARGE
DISCHARGE
DISCHARGE
DISCHARGE
DISCHARGE
EMERGENCY LIGHTS
GALLERY FRIDGE
HELM LIGHTS
MACERATOR
MASTER CABIN LIGHTS
PORT ENGINE CONTROLS
PORT ENGINE CONTROLS
PORT ENGINE CONTROLS
QUARTZ LIGHTS
STBD ENGINE CONTROLS
STBD ENGINE CONTROLS
STBD ENGINE CONTROLS
STEREO MEMORY
STORAGE BIN PUMP
WATERBLASTER

CABINE AVANT

SET-FRENCH

CABINE AVANT
CABINE BABORD
CABINE TRIBORD
DESSALINISATEUR
DIVERS
ECL INTERIEUR
ESSUIE-GLACE
FEU DE HUNE
FEU DE MOUILLAGE
FEU DE PONT
FEUX DE NAVIGATION
FLAPS TRIM TABS
GPS
GROUPE D'EAU
GUINDEAU
INSTRUMENTS
PILOTE AUTOMATIQUE
POMPE DE CALE
PRISE 12V
REFRIGERATEUR
SALLE DE BAIN
SALLE MACHINE
SONDEUR
STEREO
TABLE A CARTE
TIMONERIE
VENTILATEUR DE CALE
VHF

AUXILIAIRE 1

SET-FRENCH 2

AUXILIAIRE 1
AUXILIAIRE 2
AVERTISSEUR
CABIN 2
CABIN 3
CABIN I
CENTRALE NAV
CHAUFFAGE
CHAUFFE-EAU
CONFORT
CONGELATEUR
DIVERS
ECLAIRAGE BABORD
ECLAIRAGE CARRÉ
ECLAIRAGE NACELLE
ECLAIRAGE TRIBORD
ELECTRONIQUE
FEU TRICOLEUR
HI-FI
MICRO-ONDES
POMPE BABORD
POMPE DE LAVAGE
POMPE DOUCHE
POMPE TRIBORD
RADAR
SPOTS
TOILETTES
WINCH

Labels–Sprayproof / Battery Management Panels

CSP6

ANCHOR LIGHT

SET-1SP

ANCHOR LIGHT
< ANC. LIGHT NAV. LIGHT >
ACCESSORIES
AERATOR
AUTOPILOT
BAIT TANK PUMP
BILGE PUMP
BILGE PUMP <AUTO MAN>
BLOWER
CABIN LIGHTS
COCKPIT LIGHTS
DC OUTLETS
DECK WASH
DEPTH SOUNDER
FLOOD LIGHTS
FRESHWATER PUMP
FRIDGE
GPS
HORN
INST. LIGHTS
INSTRUMENTS
NAVIGATION LIGHTS
RADIO
SALT WATER PUMP
SPOTLIGHTS
TRIM TABS
WINCH
WIPER

SET-2SP

ANCHOR LIGHT
BILGE AUTO MAN
BOOM LIGHT
CABIN LIGHT
COCKPIT LIGHTS
COMPASS LIGHT
DECK LIGHTS
DEPTH SOUNDER
E/R BLOWER
FREEZER
INSTRUMENTS
LOCKER LIGHTS
NAV LIGHTS
PORT NAV LIGHTS
PORT WIPER
SHOWER DRAIN PUMP
SPARE 1
SPARE 2
SPARE 3
STBD NAV LIGHTS
STBD WIPER
STEAMING LIGHT
STERN LIGHT
TRANSOM LIGHTS
TRI LIGHT

CSP6

ACCESSORIES

SET-1SP/F

<MOUILLAGE NAVIGATION>
ACCESSORIES
AERATEUR
APPLIQUES DE COCKPIT
APPLIQUES INTERIEURES
AVERTISSEUR
ESSUIE-GLACE 1
ESSUIE-GLACE 2
ESSUIE-GLACE 3
FEU DE MOUILLAGE
FEU DE NAVIGATION
FRIGO
GPS
GROUPE D'EAU
INSTRUMENTS
LECTEURS DE CARTES
PILOTE AUTOMATIQUE
POMPE CALE <AUTO MANUEL>
POMPE DE CALE
POMPE DE LAVAGE
POMPE DE VIDANGE
PRISES DE COURANT
RADIO
SONDEUR
SPOTS
VENTILATEUR
WINCH

900-6WP

NAVIGATION LIGHTS

LBL-WP

ACCESSORIES
AERATOR
ANCHOR LIGHTS
AUTOPILOT
BAIT TANK PUMP
BILGE PUMP
BLOWER
CABIN LIGHTS
COCKPIT LIGHTS
DC OUTLETS
DECK WASH
DEPTH SOUNDER
FRESHWATER PUMP
FRIDGE
GPS
HORN
INST. LIGHTS
INSTRUMENTS
LOG
NAVIGATION LIGHTS
RADAR
SPARE
SPOT LIGHTS
STEREO
STERN LIGHT
TRIM TABS
VHF
WIPER

CMP-6WP

FRESHWATER PUMP

LBL-CMP

ACCESSORIES
AERATOR
ANCHOR LIGHTS
AUTOPILOT
BAIT TANK PUMP
BILGE PUMP
BLOWER
CABIN LIGHTS
COCKPIT LIGHTS
DC OUTLETS
DECK WASH
DEPTH SOUNDER
FRESHWATER PUMP
FRIDGE
GPS
HORN
INST. LIGHTS
INSTRUMENTS
LOG
NAVIGATION LIGHTS
RADAR
SPARE
SPOT LIGHTS
STEREO
STERN LIGHT
TRIM TABS
VHF
WIPER

800-MS1-4

24 HOUR LIGHTS

SET-MSP3

24 HOUR LIGHTS
BOW BILGE PUMP
BOW BILGE OVERRIDE
BOW THRUSTER
CATHODIC PROTECTION
CHARTS/SOUNDER
COCKPIT MAIN
CO DETECTOR
COCKPIT FRIDGE
ELECTRONICS MAIN
ELECTRIC CONTROLS
ELECTRIC HEAD
GENSET BATTERY CHARGER
HATCH LIFTER
HELM MAIN
HEAD MACERATOR
PORT BATTERY CHARGER
PORT ENGINE BLOWER
PORT CONTROLS
SALOON MAINS
STBD CONTROLS
STEREO
STEREO AMPLIFIER
STBD BATTERY CHARGER
STBD ENGINE BLOWER
WIPER MID
WIPER PORT
WIPER STBD
ACCESSORIES
CONTROLS

800-MS1-4

24V HOUSE VOLTMETER FEED

SET-MSP4

24V HOUSE VOLTMETER FEED
BILGE ALARM
BILGE PUMP 24 HR
BILGE PUMP AFT HIGH WATER
BILGE PUMP FWD HIGH WATER
BILGE PUMP MID HIGH WATER
BILGE PUMPS
BILGE PUMPS MAIN
FLYBRIDGE 12V MAINS
FLYBRIDGE 24V MAINS
GENSET BLOWER
HIGH WATER ALARM
HOUSE BATTERY CHARGER
HOUSE BATTERY METER
HOUSE MAIN
LOWER 12V MAINS
LOWER 24V MAINS
PORT AFT BILGE PUMP
PORT BATTER METER
PORT FWD BILGE PUMP
PORT MID BILGE PUMP
SHOWER SUMP
STBD AFT BILGE PUMP
STBD BATTERY METER
STBD FWD BILGE PUMP
STBD MID BILGE PUMP
TOILET
TWIN DISK
TWIN DISK PORT
TWIN DISK STBD

706 - 707

WINCH

SET-714

ANCHOR WINCH
BILGE PUMP AFT
BILGE PUMP FWD
BILGE PUMP MID
BILGE PUMP PORT
BILGE PUMP STARB
BOW THRUSTER
DAVIT WINCH
DC MAINS 1
DC MAINS 2
HALYARD WINCH
HEAD 1
HEAD 2
HOLDING TANK
INVERTER
MEMORY CIRCUITS
SECURITY SYSTEM
SHEET WINCH
SPARE
WASTE TREATMENT 1
WASTE TREATMENT 2

Interior Series Switch Plates

SET-INT

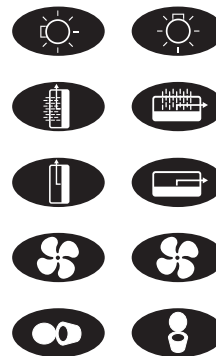

SET-INT2

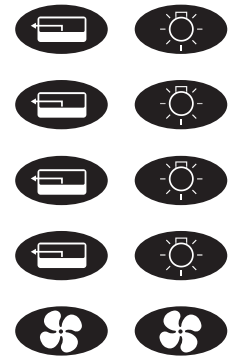

NOTE:

The complete range of BEP labels are listed in a quick reference table on our website: bepmarine.com

Labels–Battery Switches, Control Center & Contour Connect

Battery Switches 701-720

713

1			2	Some labels can be purchased separately under the following item numbers.
3			4	
			5	
6				
7				

- 1 713-HB
- 2 713-PS
- 3 713-SS
- 4 713-EP
- 5 713-BT
- 6 713-SB
- 7 713-MS

Battery Switches 770

SET-770

Circuit Breaker Modules

SET-CC-1

SET-CC-1 labels are supplied standard with any 800 series module containing toggle or push reset circuit breakers.

BATTERY CHARGER	BILGE PUMP STBD	ELECTRONICS
BILGE PUMP AFT	CATHODIC PROTECTION	ENGINE CONTROLS
BILGE PUMP ENGINE ROOM	CO DETECTOR	ENGINE CONTROLS PORT
BILGE PUMP FWD	DAVIT	ENGINE CONTROLS STBD
BILGE PUMP MID	DC MAIN	ENGINE ROOM LIGHTS
BILGE PUMP PORT	DC OUTLETS	FIRE SYSTEM
FRESH WATER PUMP	LECTRASAN	STEREO
FRIDGE	LIGHTS	STEREO MEMORY
FUEL TRANSFER PUMP	PORT BATTERY CHARGER	SUMP PUMP
HIGH WATER	SPARE	TOILET
HOLDING TANK	SPARE	TRIM TABS
HOUSE BATTERY CHARGER	STBD BATTERY CHARGER	WINCH

SET-715

--	--	--

SET-715 contains the 3 most commonly requested labels out of set 713 without the need to purchase a full label set.

Battery Control Center

SET-CC-BCC-1

RADIO BATTERY	THRUSTER BATTERY	START BATTERY
GENSET	HOUSE	PORT START
GENSET 1	HOUSE 1	MID START
GENSET 2	HOUSE 2	STBD START
BATTERY 1	24 HOUR	STEREO MEMORY
BATTERY 2	ALARM SYSTEM	ACC

Heavy-duty Circuit Breaker Modules

SET-CC-A

SET-CC-A labels are supplied standard with any 800 series module containing the heavy-duty Busman circuit breaker.

ANCHOR WINCH	HELM MAIN
DAVIT	LECTRASAN
DC MAINS	PUMPS
DECK WINCH	SALON MAINS
DOCKING WINCH	TOILET
FLYBRIDGE MAINS	WINCH

Labels-Generation 2, Micro & Interior Panels

Spray-Proof Panels Generation II

Label Set
SET-G2-1



- ACCESSORIES
- AERATOR
- ANCHOR LT
- BAIT TANK
- BILGE PUMP
- AUTO B/P MAN
- BLOWER
- CABIN LIGHTS
- COCKPIT LTS
- DC OUTLETS
- DECK WASH
- DN WINCH UP
- ELECTRONICS
- ENGRoom LTS
- FLOOD LIGHTS
- FW PUMP
- FRIDGE
- GPS
- HORN
- INST. LIGHTS



- INSTRUMENTS
- NAV LIGHTS
- RADIO
- SW PUMP
- SPOT LIGHTS
- UP PORT DN
- UP STBD DN
- WIPER

Label Set
SET-G2-2



- B/PUMP PORT
- B/PUMP STBD
- B/PUMP FWD
- B/PUMP MID
- B/PUMP AFT
- B/PUMP ENG RM
- COMPASS LT
- DECK LTS
- STEAMING LT
- NAV LTS PT
- NAV LTS STBD
- STEP LTS
- STERN LT
- WIPER PT
- WIPER MID
- WIPER STBD
- WASHERS
- FREEZER
- H/TANK PUMP
- SUMP PUMP



- LOCKER LTS
- PANEL LTS
- TRI LT
- BOW LTS
- SHOWER LT
- SHOWER PUMP
- SPARE
- SPARE

Sprayproof Switch Panels - Micro

LBL-MIC1



LBL-MICSYM

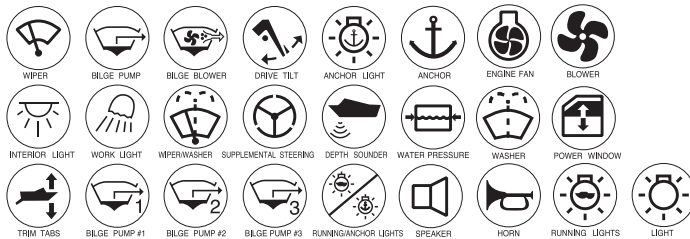

LBL-MIC2



Contour Interior Series Monitor Panels

SET-1000



SET-1002



METERS

AC & DC Systems Monitors



88

These state of the art full color monitors are made to meet the systems monitoring requirements of today's modern vessel and recreational vehicle. The DCSM and ACSM displays feature clear, extra large type face allowing for more detailed on-screen information and increased clarity. The screen has backlighting for easy night time viewing.

Tank Senders



90

A range of options for tank sender units plus interfaces for signal conversion for gauges and digital monitoring systems.



METERS

Gas Detectors



92

The BEP Detectors use microprocessor control to ensure correct sensor sensitivity. The Detectors have the capability to control two sensors which detect both LPG and Petrol, with visual and audible alarms.

Solenoid Valves



93

Remote control of the gas connection ensures safety while adding user convenience.

Analog & Digital Meters



94

Comprehensive range of meters offers monitoring solutions for batteries, AC, tanks, and systems in operation.

Fathom® e-power system with CZone® digital control and monitoring features a full complement of BEP products to perform in the harshest of environments.

AC & DC Systems Monitors

These full color monitors are made to meet the systems monitoring requirements of today's modern vessel and recreational vehicle. Complex AC and DC electrical installations onboard are becoming more common place. Additionally the increase in tank monitoring requirements for fuel, fresh, grey and black water, accurate monitoring of these systems is essential.

The DCSM and ACSM displays feature clear, extra large type face. This allows for more detailed on-screen information and increased clarity. The screen has backlighting for easy night time viewing.

DC Systems Monitor (DCSM)

Specifications:

- 2.8" color QVGA LCD
- Input voltage 8–32V DC
- Dimensions (WxH): 90 x 100 mm
- Backlit keypad

Monitors:

- Charge/discharge amps for two banks
- Capacity remaining in A/h and %
- Battery condition
- Tank fluid level
- Circuit status

Features:

- Eight generic, user configurable inputs
- Programmable high/low audio/visual alarms for volts, amps and tank levels
- Backlit keypad and dimmable screen
- Can be panel or surface mounted



Part #	Description
80-600-0021-00	DCSM including 1x shunt and cable
80-600-0022-00	DCSM excluding shunt
600-DCSM-KIT	Panel Conversion Kit for DCM to DCSM

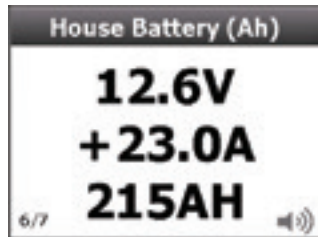

DC Power Meter

- Displays voltages of multiple battery banks (0–32V DC)
- Displays charge and discharge (amps) of two battery banks
- Displays battery capacity in amp hours
- High/Low level alarms

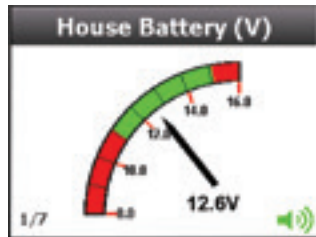

Display Type

- Configure the DCSM to show the data in analog, digital and graphic form

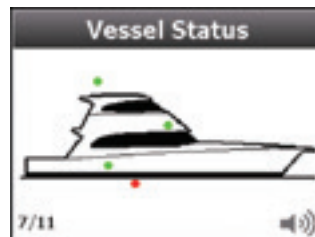

Circuit Status

- View the status of important circuits (on/off)
- In graphic and numeric form

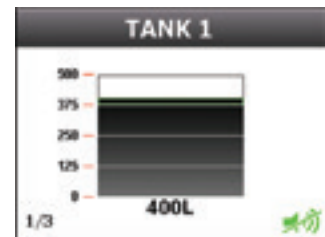

Tank Level

- View tank level information for multiple tanks in numeric and graphic forms
- Resetable when leaving boat



Installation Cable Kit

- Two core screened cable in two lengths pre-terminated

Part #	600-DCM-5M	16.45" (5 m)
Part #	600-DCM-10M	32.9" (10 m)



Ammeter Shunt Enclosure

Provides a protective housing for shunt termination meeting ABYC standards.

- Digital large: 450A - 50mV
- Analog small: 50A - 50mV, 100A - 50mV, 150A - 50mV
- Takes two small or one large shunt

Part # 711L



Ammeter Shunt

DC Current Ammeter Shunt measures DC amperage up to 450A using a scale of 0–50mV.

Part # LB-450-50

AC Systems Monitor (ACSM)

Specifications:

- 2.8" Color QVGA LCD
- Input voltage 8-32V DC
- Dimensions (WxH): 90 x 100 mm
- Backlit keypad

Monitors:

- AC volts, amps and frequency

Features:

- Three user configurable inputs
- Displays data in analog, digital and graphic forms
- Output for load shedding
- Programmable high/low audio/visual alarms for each input



Part #	Description
80-600-0023-00	ACSM including 1x AC-VSEN-4 and 2x CT-10-3
600-ACSM-KIT	Panel Conversion Kit for ACM to ACSM



AC Power Meter

- Displays AC volts, amps frequency and power for two supplies with a third position for monitoring AC volts and frequency of a third supply
- Displays AC power in kW (true RMS)



AC Volts/Frequency

- Displays AC voltage and frequency, 80-264V AC 50 & 60Hz



AC Amps

- Displays Current for 3x AC supplies (0-75A)



Alarms

- High and low alarms for each input
- User selectable alarm levels
- Mutable



AC Transducer

- The AC-VSEN-4 includes three voltage transformers for up to three voltage inputs.
- Dimensions: 2.75" x 5.5" x 2" (69 x 140 x 50 mm)

Part # AC-VSEN-4



Current Transformer

- Maximum current 120A AC
- One CT-10-3 current transformer is supplied with ACSM. If a twin line system is in use, a second CT must be ordered.
- Dimensions: 1.5" x 1.55" x .55" (37.5 x 39.2 x 13.7 mm)
- Hole size: 0.5" (12 mm)

Part # CT-10-3



Heavy-duty Current Transformer

- Maximum current 150A AC
- CT-HD is available for systems with large mains cables, too large for CT-10-3 (ordered separately).
- CT-HD dimensions: Ø 1.85 x 0.4" (Ø 47 x 10.5 mm)
- Hole size: 1.25" (32 mm)

Part # CT-HD



Surge Protection Module

Protect your electronics from becoming damaged by harmful high voltage spikes. When fitted to the battery supply these modules look for sudden increases in voltage then switch into protection mode to absorb and suppress the high energy spike.

Part # 80-707-0004-00 12V DC

Part # 80-707-0005-00 24V DC

Ultrasonic Tank Sender—No Moving Parts

- Handles common outputs – 240-33, 10-180, Vetus 10-300 for analog resistive gauges (not suitable for resistive digital gauges or CAN systems) and 0-5V tanks from BEP, Teleflex, Faria, VDO and many other popular instrument brands. (When connecting to non-adjustable gauges the TS1 must be pre-calibrated)
- Low Profile Design and standard SAE 5 hole mounting pattern, allowing it to be retrofitted to practically all other sender brands
- Can be set for tank dimensions via computer using BEP Marine's proprietary TS1 software, avoiding experimental tank filling on site
- Connects directly to the DC systems monitors (80-600-0021-00 & 80-600-0022-00 page 88) when configured to a 0-5V output
- Is set for 0-2000 mm depth off the shelf (not suitable for tank depths less than 200 mm) 8"
- Operating voltage: 10-32V
- Current draw: 25 mA with 5V gauge output
- Measurement method: Acoustic sonic measurement
- Tank depth: 0-6.5 ft (2000 mm)
- Accuracy Distance: 0-6.5 ft (2000 mm) at 2 mm accuracy
- Environmental temperature: 39.2-149°F (4-65°C)
- Chemical resistance: Petrol, diesel, water, toilet chemicals

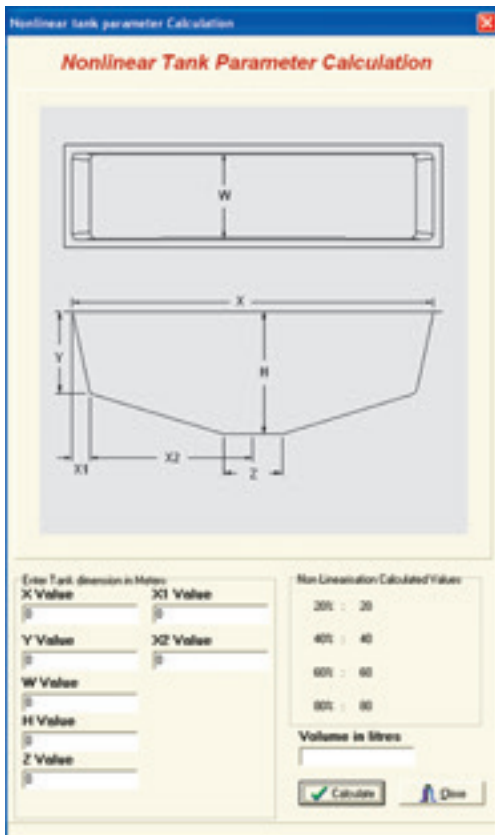
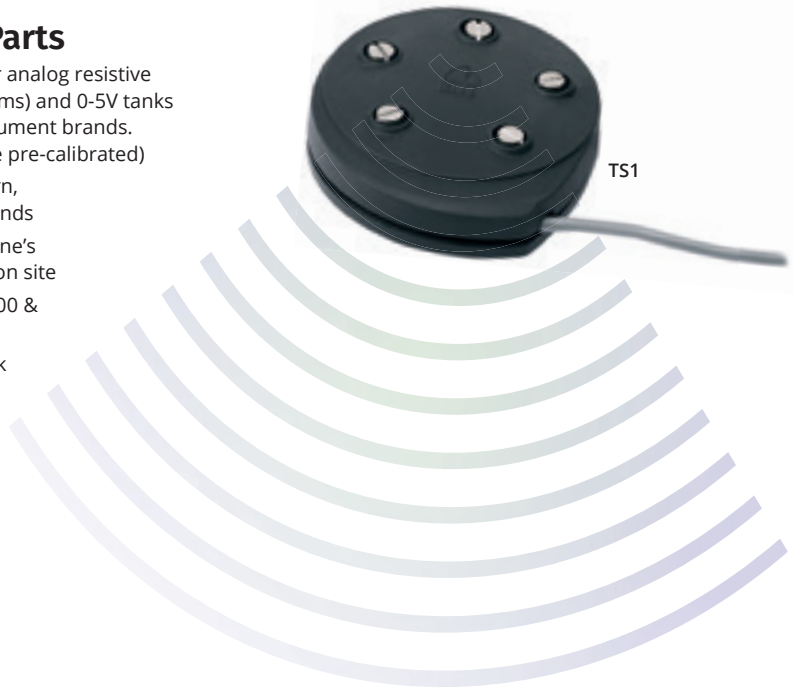
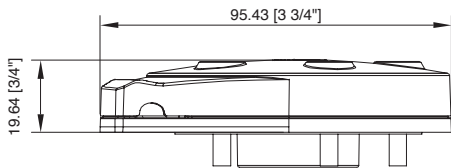

BEP's proprietary Window's based software application allows for TS1 senders to be programmed specific to tank shape, size and fluid type via a computer's USB port.

Programming is a simple process and can be carried out by downloading free software from bepmarine.com and purchasing a programming kit **TS1-PK**.

Once programmed, the specific tank parameters are stored in the non-volatile memory of the TS1. Find more detailed information at bepmarine.com



TS1 Progaming Device

Part # TS1-PK



Tank Sender Interface Module

- Only required when using VDO (10-180) or Centroid (10-180) or Teleflex (240-33) senders to produce a 0-5V signal for either the DCSM, or ACSM systems monitors.
- Switchable link for VDO or Teleflex signal. 10-32V supply.
- One unit per sender required.
- Dimensions: 2.4" x 1.3" x .9" (60 x 34 x 22 mm)

Part # 600-TLM-SIF



LED Tank Gauge

The 600-TG offers economical monitoring for fresh or grey water tanks (plastic or fiberglass only). Using 600-TGSK strategically mounted well nuts will give four tank levels. Supplied with one sender kit. Second sender ordered separately.

Also available is the RV-TS-5M Tank sender. Only one hole is required for installation, the sender is sealed via external lock nuts. Suitable for tanks with maximum depth of 280 mm.

Part # 600-TG



Tank Sender for 600-TG

Suits tanks with maximum depth of 280 mm and a maximum wall thickness of 10 mm, and a maximum hole size of 22 mm. Comes with 5 m cable.

Part # RV-TS-5M



Tank Sender for 600-TG

- Well nut hole size 3/8" (9 mm)
- Cable length 5 m
- One kit supplied with 600-TG

Part # 600-TGSK

Tank Sender Interface Module

Converts signals from up to three tanks fitted with either RV-TS-5M or 600-TGSK tank sender units, to 0-5V signal to suit ACSM and DCSM systems monitors.

Part # 80-600-0029-00

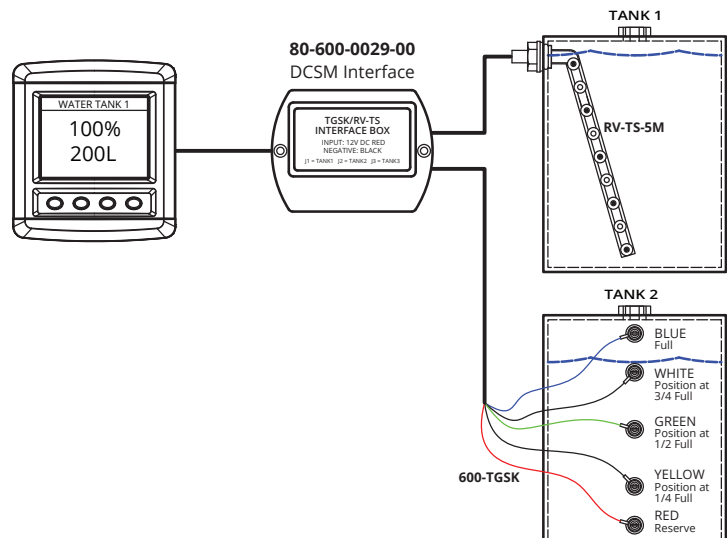

Gas Detectors

The BEP Detectors use microprocessor control to ensure correct sensor sensitivity. The Detectors have the capability to control two sensors which detect both LPG and Petrol, with visual and audible alarms.

- Dual sensors for LPG and Petrol
- Visual and audible alarms; provision for external alarm
- Automatic shut-off solenoid control with pulse and hold circuit for low power draw (600-GDL only)
- Self-testing
- Provision of bilge blower
- 2.4" x 3.5" x 0.7" (67 x 88 x 17 mm)

600-GD, 600-GDL, & FD-2 Specifications

Voltage (V DC)	10-32
Current (mA)	350 max.
Alarm Sensitivity	20% lower explosive limit
Current@Out (mA)	800 max.
Solenoid (mA)	700 pulse, 250 hold



600-GD
600-GD will detect LPG, Petrol and CNG fumes. Supplied with one sensor, with an option for a second sensor, Part # BL-SL-L output for remote alarm and blower unit. 600-GD can be used on 12 or 24V systems.



600-GDL
Same features as the 600-GD, with the ability to switch a valve on. It contains a unique "Pulse & Hold" circuit within the detector. This allows the valve to be pulled in at 12V and then once energized it will step down to hold the valve in place. This reduces power consumption and heat while the gas is turned on.



BL-SL-L
One Sensor lead supplied (5 m) with GD & GDL.
Second Sensor lead ordered separately



600-LPG
600-LPG is a stand alone gas shut-off system with no gas detection ability.



600-GDRV
600-GDRV has the sensor mounted in the front facia creating a stand alone unit. The unit is designed to be surface mounted at the vessel's lowest point.



FD-2
FD-2 is designed for an economic in-dash installation. Supplied with sensor (5 m cable) which is capable of detecting combustible gases.

Solenoid Valve & Regulator Kit

Current draw: 800mA

Current draw: 200mA when fitted with 600-GDL

Regulator flow rate: 3kPa

Gas outlet: 3/8 BSP

Gas inlet: QCC thermal nut

Outlet position: 90 degrees

Note: The VR3-12V may not comply in some countries, and does not comply with USCG requirements. Please check with your local gas installer. Not for sale in the USA.

Part # VR3-12V 12V



Solenoid Valve

The CE approved SA296COMP-12V can be installed by an approved gas installer using approved components from within specific markets. 12V or 24V options available. Uses 1/4" BSP thread.

Note: A separate regulator will need to be installed with the SA296 valves.

Part # SA296COMP-12V 12V

Part # SA296COMP-24V 24V



Analog & Digital Meters

- Contour panel/front fascia complements contour range
- All Contour Matrix monitors can fit into this style of panel



80-601-0020-00



80-601-0025-00

Panel Mounted Analog Battery Condition Meter (expanded scale)

- Panel switchable to show three different battery banks
- Available 12V (8–16V) or 24V (16–32V)

Part #	Range	Inputs
80-601-0020-00	8–16V DC	3
80-601-0021-00	16–32V DC	3
80-601-0022-00	0–150V AC	1
80-601-0023-00	0–300V AC	1

Panel Mounted Analog Ammeter Panel

- Panel switchable for use on up to three different ammeter shunts
- Supplied with one shunt, meter scales available, 0–50A 0–100A 0–150A

Part #	Range	Inputs
80-601-0024-00	0–50A DC	3
80-601-0025-00	0–100A DC	3
80-601-0026-00	0–150A DC	3

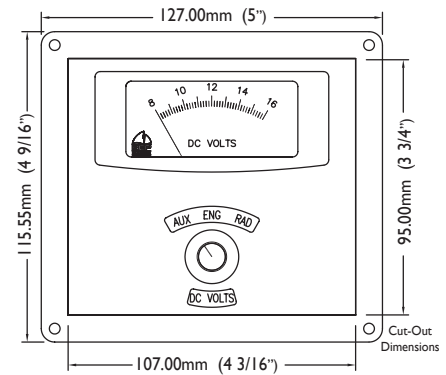

Dimensions for analog and digital panels



Panel Mounted DC Systems Monitor

- See page 88 for DCSM functionality
- Supplied with 450A–50mV shunt

Part # 80-600-0027-00



Panel Mounted AC Systems Monitor

- See page 89 for ACSM functionality
- Supplied with voltage and current transducers

Part # 80-600-0028-00

Analog Meters

- Analog meters as used in BEP Contour circuit breaker panels.
- All analog meters accurate to within 2.5%



N816DCV



N0300ACV



N0100A



N060ACT

Meters	Part #	Range	Division Marks	Shunt Type
Amp (DC)	N020A	0-20A DC	1A	Internal
	N050A	0-50A DC	2A	50A-50mV
	N0100A	0-100A DC	5A	100A-50mV
	N0150A	0-150A DC	1A	150A-50mV



When ordering optional external shunt ammeters, shunts must be ordered separately.

Meters	Part #	Range	Division Marks
Volt (DC)	N816DCV	8-16V DC	0.2V
	N1632DCV	16-32V DC	0.4V
Volt (AC)	N0150ACV	0-150V AC	10V
	N0300ACV	0-300V AC	20V
Amp (AC)	N060ACT	0-60A AC	5A



CT-10-AN must be ordered when using N060ACT or N0100ACT.

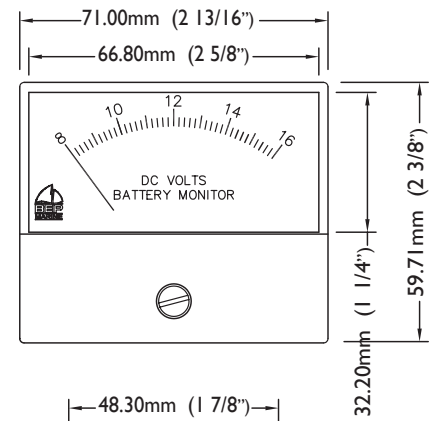

Systems in Operation Panels

- 10 mm red LED's giving important systems on information
- Ideal for flybridge or remote dash position. Also available with alarm and mute switch.
- Backlit labels

Part #	LxWxD	LxWxD	Label Set #	LEDs	Alarm	Mute switch
SOP1	4.5" x 5" x 1.6"	115 x 127 x 40 mm	1	4	No	No
SOP1-AL	4.5" x 5" x 1.6"	115 x 127 x 40 mm	1	3+1 switch	Yes	Yes
SOP2	4.5" x 9" x 1.6"	115 x 239 x 40 mm	1-2	8	No	No



SOP1



SOP2

Wire & Cable Technical Data

Conductors Sized (AWG) for 3% Voltage Drop

Use 3% voltage drop for any "critical application" affecting the safety of the vessel or its passengers: bilge pumps, navigation lights, electronics, etc....

Important!

Length (feet): Determined by measuring the length of the conductor from the positive (+) power source connection to the electrical device and back to the negative (-) power source connection. Note that the power source connection may be either the battery, panelboard or switchboard.

Current (amps): Determined by adding the total amps on a circuit. Conductor sizes not covered in Table B or Table C may be calculated by using the following formula:

$$CM = \frac{K \times I \times L}{E}$$

After calculating the Circular Mil Area (CM), use Table E to determine the proper conductor size (National Fire Protection Agency and Coast Guard require that the next larger conductor be used when the calculated CM area falls between the two conductor sizes).

CM = Circular Mil Area of Conductors
K = 10.75 (Constant representing the mil-foot resistance of copper)

I = Current - amps / **L** = Length - feet

E = Voltage drop at load (in voltage drop in a decimal expression)

For Example...

Q: A bilge pump draws 10 amps. The positive run is 11 feet from the power panel, including the float switch. The negative run is only 10 feet. What size is the wire?

A: Use the formula to reach the correct answer:

Table D shows that 12 AWG wire has a CM area of 6,500 and is the correct choice. However, SAE wire has a CM area of only 5,833. Under NFPA and USCG regulations, 10 SAE wire must be used.

3% Voltage Drop at 12 Volts

Length		Current (Amps)												
		5	10	15	20	25	30	40	50	60	70	80	90	100
10'	3 m	18	14	12	10	10	8	6	6	6	6	4	4	
15'	5 m	16	12	10	10	8	8	6	6	4	4	4	2	2
20'	6 m	14	10	10	8	6	6	6	4	4	2	2	2	2
25'	8 m	12	10	8	6	6	6	4	4	2	2	2	1	1
30'	9 m	12	10	8	6	4	4	4	2	2	2	2	1	1
40'	12 m	10	8	6	6	4	4	2	2	1	1/0	1/0	2/0	2/0
50'	15 m	10	6	6	4	4	2	2	1	1/0	2/0	3/0	4/0	4/0
60'	18 m	10	6	6	4	2	2	1	1/0	2/0	3/0	3/0	4/0	4/0
70'	21 m	8	6	4	2	2	1	1/0	2/0	3/0	3/0	4/0	4/0	
80'	24 m	8	6	4	2	2	1	1/0	2/0	3/0	4/0	4/0		
90'	27 m	8	4	2	2	1	1/0	2/0	3/0	4/0	4/0			
100'	30 m	6	4	2	2	1	1/0	2/0	3/0	4/0				
110'	33 m	6	4	2	2	1	1/0	2/0	3/0	4/0				
120'	36 m	6	4	2	1	1/0	2/0	3/0	4/0					
130'	40 m	6	2	2	1	1/0	2/0	3/0	4/0					
140'	43 m	6	2	2	1/0	2/0	3/0	4/0						
150'	46 m	6	2	1	1/0	2/0	3/0	4/0						
160'	49 m	6	2	1	1/0	2/0	3/0	4/0						
170'	52 m	6	2	1	2/0	3/0	3/0	4/0						

3% Voltage Drop at 24 Volts

Length		Current (Amps)												
		5	10	15	20	25	30	40	50	60	70	80	90	100
10'	3 m	18	18	16	14	12	12	10	10	10	8	8	8	6
15'	5 m	18	16	14	12	12	10	10	8	8	6	6	6	6
20'	6 m	18	14	12	10	10	10	8	6	6	6	6	4	4
25'	8 m	16	12	12	10	10	8	6	6	6	4	4	4	4
30'	9 m	16	12	10	10	8	8	6	6	4	4	4	2	2
40'	12 m	14	10	10	8	6	6	6	4	4	2	2	2	2
50'	15 m	12	10	8	6	6	6	4	4	2	2	2	1	1
60'	18 m	12	10	8	6	6	4	4	2	2	1	1	1/0	1/0
70'	21 m	12	8	6	6	4	4	2	2	1	1	1/0	1/0	2/0
80'	24 m	10	8	6	6	4	4	2	2	1	1/0	1/0	2/0	2/0
90'	27 m	10	8	6	4	4	2	2	1	1/0	1/0	2/0	2/0	3/0
100'	30 m	10	6	6	4	4	2	2	1	1/0	2/0	2/0	3/0	3/0
110'	33 m	10	6	6	4	2	2	1	1/0	1/0	2/0	3/0	3/0	4/0
120'	36 m	10	6	4	4	2	2	1	1/0	2/0	3/0	3/0	4/0	4/0
130'	40 m	8	6	4	2	2	2	1	1/0	2/0	3/0	3/0	4/0	4/0
140'	43 m	8	6	4	2	2	1	1/0	2/0	3/0	3/0	4/0	4/0	
150'	46 m	8	6	4	2	2	1	1/0	2/0	3/0	3/0	4/0	4/0	
160'	49 m	8	6	4	2	2	1	1/0	2/0	3/0	4/0	4/0	4/0	
170'	52 m	8	6	2	2	1	1	2/0	3/0	3/0	4/0	4/0		

3% Voltage Drop at 32 Volts

Length		Current (Amps)												
		5	10	15	20	25	30	40	50	60	70	80	90	100
10'	3 m	18	18	16	16	14	14	12	12	10	10	10	8	8
15'	5 m	18	16	14	14	12	12	10	10	8	8	8	6	6
20'	6 m	18	16	12	12	12	10	10	8	8	6	6	6	6
25'	8 m	18	14	12	12	10	10	8	8	6	6	6	6	4
30'	9 m	16	14	10	10	10	8	8	6	6	6	4	4	4
40'	12 m	16	12	10	10	8	8	6	6	4	4	4	2	2
50'	15 m	14	12	8	8	8	6	6	4	4	2	2	2	2
60'	18 m	14	10	8	8	6	6	4	4	2	2	2	2	1
70'	21 m	12	10	6	6	6	6	4	2	2	2	1	1	0
80'	24 m	12	10	6	6	6	4	4	2	2	1	1	0	0
90'	27 m	12	8	6	6	6	4	2	2	2	1	1/0	1/0	2/0
100'	30 m	12	8	6	6	4	4	2	2	1	1/0	1/0	2/0	2/0
110'	33 m	10	8	6	6	4	4	2	2	1	1/0	1/0	2/0	2/0
120'	36 m	10	8	6	4	4	2	2	1	1/0	1/0	2/0	2/0	3/0
130'	40 m	10	8	6	4	4	2	2	1	1/0	2/0	2/0	3/0	3/0
140'	43 m	10	6	6	4	2	2	1	1/0	1/0	2/0	3/0	3/0	3/0
150'	46 m	10	6	6	4	2	1	1	1/0	2/0	2/0	3/0	3/0	4/0
160'	49 m	10	6	4	4	2	1	1	1/0	2/0	3/0	3/0	4/0	4/0
170'	52 m	8	6	4	2	2	1	1	1/0	2/0	3/0	3/0	4/0	4/0

Wire & Cable Technical Data

Conductors Sized (AWG) for 10% Voltage Drop

Use 10% voltage drop for any "non-critical" applications: windlass, cabin lights, etc....

10% Voltage Drop at 12 Volts

Length		Current (Amps)												
		5	10	15	20	25	30	40	50	60	70	80	90	100
10'	3 m	18	18	18	16	16	14	14	12	12	10	10	10	10
15'	5 m	18	18	16	14	14	12	12	10	10	8	8	8	8
20'	6 m	18	16	14	14	12	12	10	10	8	8	8	6	6
25'	8 m	18	16	14	12	12	10	10	8	8	6	6	6	6
30'	9 m	18	14	12	12	10	10	8	8	6	6	6	6	4
40'	12 m	16	14	12	10	10	8	8	6	6	6	4	4	4
50'	15 m	16	12	10	10	8	8	6	6	4	4	4	2	2
60'	18 m	14	12	10	8	8	6	6	4	4	2	2	2	2
70'	21 m	14	10	8	8	6	6	6	4	2	2	2	2	1
80'	24 m	14	10	8	8	6	6	4	4	2	2	2	1	1
90'	27 m	12	10	8	6	6	6	4	2	2	2	1	1	1/0
100'	30 m	12	10	8	6	6	4	4	2	2	1	1	1/0	1/0
110'	33 m	12	8	8	6	6	4	2	2	2	1	1/0	1/0	1/0
120'	36 m	12	8	6	6	4	4	2	2	1	1	1/0	1/0	2/0
130'	40 m	12	8	6	6	4	4	2	2	1	1/0	1/0	2/0	2/0
140'	43 m	10	8	6	6	4	2	2	1	1	1/0	2/0	2/0	2/0
150'	46 m	10	8	6	4	4	2	2	1	1/0	1/0	2/0	2/0	3/0
160'	49 m	10	8	6	4	4	2	2	1	1/0	2/0	2/0	3/0	3/0
170'	52 m	10	6	6	4	2	2	2	1	1/0	2/0	2/0	3/0	3/0

10% Voltage Drop at 24 Volts

Length		Current (Amps)												
		5	10	15	20	25	30	40	50	60	70	80	90	100
10'	3 m	18	18	18	18	18	18	16	16	14	14	14	12	12
15'	5 m	18	18	18	18	16	16	14	14	12	12	12	10	10
20'	6 m	18	18	18	16	16	14	14	12	12	10	10	10	10
25'	8 m	18	18	16	16	14	14	12	12	10	10	8	8	8
30'	9 m	18	18	16	14	14	12	12	10	10	8	8	8	8
40'	12 m	18	16	14	14	12	12	10	10	8	8	8	6	6
50'	15 m	18	16	14	12	12	10	10	8	8	6	6	6	6
60'	18 m	18	14	12	12	10	10	8	8	6	6	6	6	4
70'	21 m	16	14	12	10	10	8	8	6	6	6	6	4	4
80'	24 m	16	14	12	10	10	8	8	6	6	6	4	4	4
90'	27 m	16	12	10	10	8	8	6	6	6	4	4	4	2
100'	30 m	16	12	10	10	8	8	6	6	4	4	4	2	2
110'	33 m	14	12	10	8	8	8	6	6	4	4	2	2	2
120'	36 m	14	12	10	8	8	6	6	4	4	2	2	2	2
130'	40 m	14	12	10	8	8	6	6	4	4	2	2	2	2
140'	43 m	14	10	8	8	6	6	6	4	2	2	2	2	1
150'	46 m	14	10	8	8	6	6	4	4	2	2	2	2	1
160'	49 m	14	10	8	8	6	6	4	4	2	2	2	1	1
170'	52 m	12	10	8	6	6	6	4	2	2	2	2	1	1

10% Voltage Drop at 32 Volts

Length		Current (Amps)												
		5	10	15	20	25	30	40	50	60	70	80	90	100
10'	3 m	18	18	18	18	18	18	18	16	16	14	14	14	14
15'	5 m	18	18	18	18	18	18	16	14	14	14	12	12	12
20'	6 m	18	18	18	18	16	16	14	14	12	12	12	10	10
25'	8 m	18	18	18	16	16	14	14	12	12	10	10	10	10
30'	9 m	18	18	18	16	14	14	12	14	10	10	10	10	8
40'	12 m	18	18	16	14	14	12	12	10	10	8	8	8	8
50'	15 m	18	16	14	14	12	12	10	10	8	8	8	6	6
60'	18 m	18	16	14	12	12	10	10	8	8	8	6	6	6
70'	21 m	18	14	14	12	10	10	8	8	8	6	6	6	6
80'	24 m	18	14	12	12	10	10	8	8	6	6	6	6	4
90'	27 m	18	14	12	10	10	10	8	6	6	6	6	4	4
100'	30 m	16	14	12	10	10	8	8	6	6	6	4	4	4
110'	33 m	16	14	12	10	10	8	8	6	6	6	4	4	4
120'	36 m	16	12	10	10	8	8	6	6	6	4	4	4	2
130'	40 m	16	12	10	10	8	8	6	6	6	4	4	2	2
140'	43 m	14	12	10	8	8	8	6	6	4	4	2	2	2
150'	46 m	14	12	10	8	8	6	6	6	4	4	2	2	2
160'	49 m	14	12	10	8	8	6	6	4	4	2	2	2	2
170'	52 m	14	12	10	8	8	6	6	4	4	2	2	2	2

Wire & Cable Technical Data

Conductor Sizes

AWG	mm ²	AWG CM area	SAE CM area	Ampacity Outside	Engine Space Inside
18	0.8	1,600	1,537	20	17
16	1	2,600	2,336	25	21
14	2	4,100	3,702	35	30
12	3	6,500	5,833	45	38
10	5	10,500	9,343	60	51
8	8	16,800	14,810	80	68
6	13	26,600	24,538	120	102
4	21	42,000	37,360	160	136
2	34	66,500	62,450	210	178
1	42	83,690	77,790	245	208
1/0	53	105,600	98,980	285	242
2/0	68	133,100	125,100	330	280
3/0	85	167,800	158,600	385	327
4/0	107	211,600	205,500	445	378

PN	Page	PN	Page	PN	Page	PN	Page	PN	Page
1000-6W	67	1001704	54	1002008	57	185040F-01-1	49	600-GDRV	92
1000-6W-24V	67	1001705	54	1002009	57	185040F/DSP	49	600-LPG	92
1000-ACSM	67	1001706	54	1002010	56	185040P-01-1	49	600-TG	91
1000-DCSM	67	1001707	54	1002011	57	185040P/DSP	49	600-TGSK	91
1000-VM-12V	67	1001708	54	1002012	57	185050F-01-1	49	600-TLM-SIF	91
1001001	60	1001709	54	1002013	56	185050F/DSP	49	700	16
1001002	60	1001710	54	1002014	57	185050P-01-1	49	700B	16
1001101	61	1001711	54	1002015	56	185050P/DSP	49	701	16, 29
1001102	61	1001712	54	1002016	57	185060F-01-1	49	701-KEY	17, 19
1001103	61	1001713	54	1002017	57	185060F/DSP	49	701-KEY-EP	17, 19
1001104	61	1001714	54	1002018	57	185060P-01-1	49	701-MD	18
1001301	58	1001715	54	1002019	57	185060P/DSP	49	701-MD-D	18
1001302	58	1001716	54	1002020	57	185070F-01-1	49	701-MDVS	20
1001303	58	1001801	53	1002021	56	185070F/DSP	49	701-MDVS-24V	20
1001304	58	1001802	53	1002022	56	185070P-01-1	49	701-PM	17
1001305	58	1001803	53	1002023	56	185070P/DSP	49	701B	16
1001306	58	1001804	53	1002024	56	185080F-01-1	49	701B-PM	17
1001307	58	1001805	53	1002025	56	185080F/DSP	49	701S	16
1001308	58	1001806	53	1002027	56	185080P-01-1	49	701S-B	16
1001401	55	1001807	53	1002101	60	185080P/DSP	49	701S-B-PM	17
1001402	55	1001808	53	1002102	60	185100F-01-1	49	701S-PM	17
1001501	55	1001809	53	1002203	61	185100F/DSP	49	702-2S/B	42
1001502	55	1001810	53	1002204	61	185100P-01-1	49	702-2S/B	42
1001503	55	1001811	53	1002205	61	185100P/DSP	49	702-2SB/L	42
1001504	55	1001812	53	1002301	60	185120F-01-1	49	702-8-10-B	42
1001505	55	1001901	56	1100-BK	67	185120P-01-1	49	702-MFH	47
1001506	55	1001902	56	1101-BK	67	185120P/DSP	49	702-MFH-B	47
1001507	55	1001903	56	1101-BK-TS	67	185135F-01-1	49	702B	42
1001508	55	1001904	56	121-710-1101/1	51	185135P-01-1	49	702B	42
1001509	55	1001905	57	124001000	50	185135P/DSP	49	702SB	42
1001601	60	1001906	56	12VDUSB	66	185150F-01-1	49	704-4S/B	42
1001602	60	1001907	56	12VDUSB-B	66	185150F/DSP	49	704-4S/B	42
1001603	59	1001908	56	12VDUSBN-B	66	185150P-01-1	49	705-100A	43
1001604	59	1002001	56	12VDUSBW-B	66	185150P/DSP	49	705-100A/B	43
1001605	59	1002002	56	12VPG	66	600-ACSM-KIT	89	705-135A	43
1001606	59	1002003	57	12VRC	66	600-DCM-10M	88	705-135A/B	43
1001607	59	1002004	56	185030F-01-1	49	600-DCM-5M	88	705-150A	43
1001608	59	1002005	57	185030F/DSP	49	600-DCSM-KIT	88	705-150A/B	43
1001609	59	1002006	56	185030P-01-1	49	600-GD	92	705-50A	43
1001610	59	1002007	57	185030P/DSP	49	600-GDL	92	705-50A/B	43

PN	Page	PN	Page	PN	Page	PN	Page	PN	Page
705-80A	43	720-MDO-EP	20	778-ANL2S	33, 35	80-511-0031-00	68	900-2WP	65
705-80A/B	43	720-MDVSO	20	778-ANL2S-B	35	80-511-0031-01	68	900-2WPMOM	65
706-2W	43	720B	16	778-ANLTP	33, 35	80-600-0021-00	88	900-2WPOFO	65
706-2W/B	43	721	16	778-ANLTP-B	35	80-600-0022-00	88	900-3WPS	65
706-4W/B	43	721B	16	778-T2S-400	33, 35	80-600-0023-00	89	900-4WP	65
706-4WB	43	770-B	14	778-T2S-400-B	35	80-600-0027-00	94	900-5WPS	65
707	43	770-DP	14	778-T2S-600	33, 35	80-600-0028-00	94	900-5WPUSB	65
708-107-V3	28	770-DP-B	14	778-T2S-600-B	35	80-600-0029-00	91	900-6WP	65
708-42.5	28, 42	770-DP-EZ	14	779-LB-1-B	38	80-601-0020-00	94	900-AC1	78
708-54.5	42	770-DP-EZ-B	14	779-LB-2-B	38	80-601-0021-00	94	900-AC1-110V	78
708-62.0	42	770-EZ	14	779-LBJ-2-B	38	80-601-0022-00	94	900-AC1H-ACSM	78
708-64.5	42	770-EZ-B	14	779-LBJ-2-B5	38	80-601-0023-00	94	900-AC2H-ACSM	78, 79
708-68.5	42	770-KEY-EP	14, 15	779-LBJ-3-B	38	80-601-0024-00	94	900-AC2H-ACSM-110	78, 79
708-70.0	28	770	14	779-LBJ-4-B	38	80-601-0025-00	94	900-AC2V-ACSM	79
710-140A	21	77049020	46	779-LBJ-5-B	38	80-601-0026-00	94	900-AC2V-ACSM-110	79
710-140A-B	21	77049160	46	779-LBJ-6-B	38	80-700-0050-00	26	900-AC3-ACSM	79
711L	88	77049400	46	779-LBZ-1-B	38	80-700-0051-00	26	900-AC3-ACSM-110	79
713	29, 84	771-S	14	779-LBZ-2-B	38	80-700-0052-00	26	900-AC4-ACSM	79
713-BT	84	771-S-B	14	80-511-0001-00	68	80-701-0018-00	20	900-AC4-ACSM-110	79
713-EP	84	771-S-EZ	14	80-511-0001-01	68	80-707-0004-00	89	900-ACCH	78
713-HB	84	771-S-EZ-B	14	80-511-0002-00	68	80-707-0005-00	89	900-ACCH-110V	78
713-MS	84	771-SFD	14	80-511-0002-01	68	80-708-0013-00	19	900-ACM2W	78
713-PS	84	772-DBC	14	80-511-0003-00	68	80-708-0017-00	19	900-ACM2W-110V	78
713-SB	84	772-DBC-B	14	80-511-0003-01	68	80-712-0039-00	47	900-ACM6V-ACSM	78
713-SS	84	772-DBC-EZ	14, 15	80-511-0004-00	68	80-712-0039-01	47	900-ACM6V-ACSM-110	78
714-140A-DVSR	22, 24	772-DBC-EZ-B	14	80-511-0004-01	68	80-716-0014-00	26	900-ACM6W	78
714-140A-DVSR-B	22	777-BB3S-650	33, 34	80-511-0005-00	68	80-716-0015-00	26	900-ACM6W-110V	78
715-H	22, 24	777-BB3S-650-B	34	80-511-0005-01	68	80-716-0016-00	26	900-BA	65
715-S	23, 24	777-BB4S-500	33, 34	80-511-0006-00	68	80-716-0017-00	25	900-DC	72
715-V	22, 24	777-BB4S-500-B	34	80-511-0006-01	68	80-716-0018-00	25	900-RCD-16A	50
716-H-140A-DVSR	23, 24	777-BB5S-650	33, 34	80-511-0007-00	68	80-716-0030-00	8	900-RCD-1X16-32A	50
716-SQ-140A-DVSR	23, 24	777-BB5S-650-B	34	80-511-0007-01	68	80-716-0031-00	8	900-RCD-2X16A	50
716-V-140A-DVSR	23, 24	777-BB8S-650	33, 34	80-511-0008-00	68	80-716-0032-00	8	900-RCD-2X32A	50
717-140A-DVSR	24	777-BB8S-650-B	34	80-511-0008-01	68	80-724-0006-00	19	900-RCD-32A	50
718-140A-DVSR	23, 24	777-Z10W-200	33, 34	80-511-0009-00	68	80-724-0007-00	20	900-SOP	65
719-140A-DVSR	24	777-Z10W-200-B	34	80-511-0009-01	68	80-911-0045-00	19	900V-DCSM	74
720	16	777-Z18W-200	33, 34	80-511-0010-00	68	800-MS1	29	901H	72
720-DP	16	777-Z18W-200-B	34	80-511-0010-01	68	800-MS2	29	901V	72
720-DP/B	16	778-ANL	33, 35	80-511-0011-01	68	800-MS3	29	901V-DCSM	74
720-MDO	18	778-ANL-B	35	80-511-0012-01	68	800-MS4	29	902-DCSM	74

PN	Page	PN	Page	PN	Page	PN	Page	PN	Page
902NMH	72	BC-FM2	80	CBS-40A-DP	51	CSP6-F	66	IP80P/DSP	46
902NMV	72	BC-FM3	80	CBS-40A-SP	51	CSP6-PTC	66	IS-10MM-1	40
902V-DCSM	74	BC-FM4	80	CBS-50A-DP	51	CT-10-3	89	IS-10MM-1R	40
903-DCSM	74	BC-PM1	80	CBS-50A-DP-TC230	51	CT-HD	89	IS-10MM-2	40
904-DCSM	74	BC-PM2	80	CBS-50A-SP	51	FANL-600-B	46	IS-10MM-2/L	40
904NM	72	BFHD-30A	46	CBS-50A-SP-IGP	51	FANL-675-B	46	IS-6MM-1	40
904NM-DP	76	BFHD-30A/DSP	46	CBS-50A-TP	51	FANL-750-B	46	IS-6MM-1/DSP	40
904NMH	72	BFHD-40A	46	CBS-5A-SP	51	FD-2	92	IS-6MM-1R	40
904NMV	73	BFHD-40A/DSP	46	CC-1	28	FT-225-B	46	IS-6MM-1R/DSP	40
905-DCSM	74	BFHD-50A	46	CC-5	28	FT-250-B	46	IS-6MM-2/DSP	40
905NM	73	BFHD-50A/DSP	46	CC-801	27	FT-300-B	46	IS-8MM-1	40
905NMV	73	BFHD-60A	46	CC-802	27	FT-350-B	46	ISC-10BK	40
905V-DCSM	74	BFHD-60A/DSP	46	CC-803N	27	FT-400-B	46	ISC-10R	40
906-DCSM	75	BFHD-70A	46	CC-804	28	FT-450-B	46	ISC-6-2	40
906NMH	73	BFHD-70A/DSP	46	CC-810	27	FT-500-B	46	ISC-6-2R	40
906NMV	73	BFHD-80A	46	CC-BLANK	28	FT-600-B	46	IST-10MM-1S	33, 36
906V-DCSM	75	BFHD-80A/DSP	46	CC-HDBM	28	HDBFH	47	IST-10MM-1S-B	36
907-DCSM	75	BL-SL-L	92	CG2-2W	64	IP100	46	IST-10MM-1SPT	33, 36
AC-VSEN-4	89	BSP-1	17	CG2-2W-F	64	IP100P/DSP	46	IST-10MM-1SPT-B	36
ATC-6W	47	CBL-100A-DP	51	CG2-4W	64	IP125	46	IST-10MM-2S	33, 36
ATC-6W/B	47	CBL-100A-SP	29, 51	CG2-4W-F	64	IP150	46	IST-10MM-2S-B	36
ATC-6WQC	47	CBL-100A-TP	51	CG2-6W	64	IP150P/DSP	46	IST-10MM-8MM	33, 36
BB-12W-2NC	41	CBL-50A-SP	29, 51	CG2-6W-F	64	IP175	46	IST-10MM-8MM-B	36
BB-12W-2NC/DSP	41	CBL-60A-DP	51	CG2-JB	64	IP200	46	IST-8MM-1S	33, 36
BB-12W-2S	41	CBL-60A-SP	51	CLB-05	50	IP200P/DSP	46	IST-8MM-1S-B	36
BB-12W-2S/DSP	41	CBL-75A-SP	29, 51	CLB-05/DSP	50	IP250	46	IST-8MM-1SPT	33, 36
BB-24W-2S	41	CBL-80A-TP	51	CLB-10	50	IP250P/DSP	46	IST-8MM-1SPT-B	36
BB-24W-2S/DSP	41	CBS-10A-DP	51	CLB-10/DSP	50	IP300	46	IST-8MM-2S	33, 36
BB-4S-150A	41	CBS-10A-SP	51	CLB-15	50	IP300P/DSP	46	IST-8MM-2S-B	36
BB-4S-150A/DSP	41	CBS-15A-DP	51	CLB-15/DSP	50	IP355	46	J01A	46
BB-6W-2S	41	CBS-15A-DP-TC230	51	CLB-20	50	IP40	46	J02A	46
BB-6W-2S/DSP	41	CBS-15A-SP	51	CLB-20/DSP	50	IP425	46	J03A	46
BB-LINK17MM	47	CBS-20A-DP	51	CLB-25	50	IP425P/DSP	46	J05A	46
BBC-12WBK	41	CBS-20A-DP-TC230	51	CLB-25/DSP	50	IP50	46	J10A	46
BBC-12WR	41	CBS-20A-SP	51	CLB-30	50	IP500	46	J15A	46
BBC-24WBK	41	CBS-25A-DP	51	CLB-30/DSP	50	IP500P/DSP	46	J20A	46
BBC-24WR	41	CBS-25A-SP	51	CLB-40	50	IP50P/DSP	46	J25A	46
BBC-6WBK	41	CBS-30A-DP	51	CLB-40/DSP	50	IP63	46	J30A	46
BBC-6WR	41	CBS-30A-DP-TC230	51	CLB-BOOT	50	IP63P/DSP	46	J40A	46
BC-FM1	80	CBS-30A-SP	51	CSP6	66	IP80	46	J7.5A	46

PN	Page	PN	Page	PN	Page
LB-450-50	88	NHP-RCBO-16A30MA-1D	50	SW-6064C3P	67
LBL-MIC1	85	NHP-RCBO-16A30MA-2D	50	SW-6064D3P	67
LBL-MIC2	85	NHP-RCBO-32A30MA-1D	50	SW-CG1	64
LBL-MICSYM	85	NHP-RCBO-32A30MA-2D	50	SW-CG2	64
M28-DCSM	77	PMCC-10	50	SW-CG3	64
M32-DCSM	77	RES-12WAY	73	SW-CG4	64
M44-DCSM	77	RES-16WAY	73	SW-CG5	64
M44H-DCSM	77	RES-20WAY	73	SW-M331	66
M56-DCSM	77	RES-24WAY	73	SW-RVS2	67
MCB-3WENC	50	RES-28WAY	73	TB-118-10P	41
MRBF-100A	48	RES-32WAY	73	TB-118-6P	41
MRBF-100A-B	48	RES-36WAY	73	TS1	90
MRBF-125A	48	RES-44WAY	73	TS1-PK	90
MRBF-125A-B	48	RES-4WAY	73	VR3-12V	93
MRBF-150A	48	RES-8WAY	73	WAFH-14	47, 66
MRBF-150A-B	48	RV-TS-5M	91		
MRBF-200A	48	SA296COMP-12V	93		
MRBF-200A-B	48	SA296COMP-24V	93		
MRBF-300A	48	SET-1000	85		
MRBF-300A-B	48	SET-1002	85		
MRBF-50A	48	SET-15P	66		
MRBF-50A-B	48	SET-715	84		
MRBF-80A	48	SET-770	84		
MRBF-80A-B	48	SET-CC-1	84		
MRCBF-200A	48	SET-CC-A	84		
MRCBF-200A-B	48	SET-CC-BCC-1	84		
MRCBP-200A	48	SET-G2-1	64, 85		
MRCBP-200A-B	48	SET-G2-2	85		
N0100A	95	SET-INT	83		
N0150A	95	SET-INT2	83		
N0150ACV	95	SOP1	95		
N020A	95	SOP1-AL	95		
N0300ACV	95	SOP2	95		
N050A	95	SW-32111	66		
N060ACT	95	SW-32113	66		
N1632DCV	95	SW-32114	66		
N816DCV	95	SW-32115	66		
NC32Y-DCSM	76	SW-32120	66		
NC36L-DCSM	76	SW-32123	66		
NC36NM	73	SW-6064B3P	67		

Ingress Protection (IP) Ratings Guide













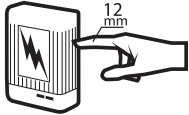

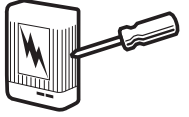
Example:

An IP65 rating can be determined using the adjacent table and example:

- The first number of the rating example, 6, in the gray column means the enclosure is dust tight
- The second number of the rating example, 5, in the blue column means the enclosure is protected against jets of water

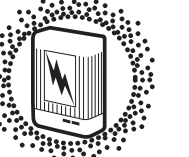
The IP rating system was established by the International Electrotechnical Commission (IEC), an organization for international standards and conformity assessment. The IEC collaborates closely with the International Organization for Standardization (ISO). A complete description of the IP ratings and associated tests is found in IEC Publication 529. Although these ratings were initially developed as a way to classify enclosures, they now provide a convenient, practical way to compare levels of sealing. Many electrical products have an Ingress Protection (IP) rating which identifies the environmental factors needing consideration prior to the product's installation.

This is important when deciding when to mount products in a dry and clean environment versus a wet and/or dusty environment. The IP rating indicates the degree of protection provided. The numbers following IP represent levels of sealing and can range from no protection to full protection against dust and water. The table provides a description of the protection at each level.

SOLIDS		WATER	
1	 Protected against a solid object greater than 50 mm such as a hand.	1	 Protected against vertically falling drops of water. Limited ingress permitted.
2	 Protected against a solid object greater than 12 mm such as a finger.	2	 Protected against vertically falling drops of water with enclosure tilted up to 15 degrees from the vertical. Limited ingress permitted.
3	 Protected against a solid object greater than 2.5 mm such as a screwdriver.	3	 Protected against sprays of water up to 60 degrees from the vertical. Limited ingress permitted for three minutes.
4	 Protected against a solid object greater than 1 mm such as a wire.	4	 Protected against water splashed from all directions. Limited ingress permitted.
5	 Dust Protected. Limited ingress of dust permitted. Will not interfere with operation of the equipment. Two to eight hours.	5	 Protected against jets of water. Limited ingress permitted.
6	 Dust tight. No Ingress of dust. Two to eight hours.	6	 Water from heavy seas or water projected in powerful jets shall not enter the enclosure in harmful quantities.
		7	 Protection against the effects of immersion in water between 15 cm and 1 m for 30 minutes.
		8	 Protection against the effects of immersion in water under pressure for long periods.

Rating Example:

IP65

INGRESS PROTECTION



Americas

N85 W12545 Westbrook Crossing
Menomonee Falls, WI 53051 USA
p 800.307.6702

Asia Pacific

42 Apollo Drive
Rosedale, Auckland 0632
New Zealand
p +64.9.415.7261

Europe, Middle East & Africa

Snijdersbergweg 93
1105 AN Amsterdam
The Netherlands
p +31(0)20 34 22 100

tech.marinco@oneasg.com
bepmarine.com

© 2024 Navico Group. All Rights Reserved.
Navico Group is a division of Brunswick Corporation

@Reg. U.S. Pat. & Tm. Off, and ™ common law marks. Visit www.navico.com/intellectual-property to review the global trademark rights and accreditations for Navico Group and other entities.

Unauthorized copying or reproduction is a violation of applicable laws.

BEP-001-CAT-0423

FSC Details
(added by printers)