



MARINCO®

MARINE
EMERGENCY VEHICLE
INDUSTRIAL
RV

2023

NAVICO GROUP

Your most trusted partner

Navico Group is the world's leading supplier of integrated systems and products to industries ranging from marine to recreational vehicles. We bring together the best brands, products and people to create groundbreaking innovations that reinvent the consumer experience. Our broad portfolio of the industry's leading brands in power management, digital control & monitoring, networked devices, and marine electronics are distributed globally to a diverse aftermarket and OEM customer base. Navico Group is driven, every day, to be the world's most trusted partner to the marine and mobile industries, and beyond.



Lighting
Marine Accessories
Water and Fuel Systems
attwoodmarine.com



Wire
Wire Management
ancorproducts.com



Battery Management
Circuit Protection
Power Distribution
blueseas.com



Chartplotters
Radar
Autopilots
Sonar Technology
simrad-yachting.com



Digital Control & Monitoring
Onboard Offboard UX
czone.net



Battery Management
Power Distribution
bepmarine.com



Battery Chargers
promariner.com



Chartplotters
Displays
Instruments
Sensors
bandg.com



Lithium Batteries
Portable Power
AGM Batteries
relionbattery.com



Trolling Motors
motorguide.com



Heating Systems
Pumps
whalepumps.com



Marine Cartography
c-map.com



AC Shore Power
Marine Accessories
marinco.com



Actuators
Trim Tab System
lencmarine.com



Metal Fabricated
Hardware
garelick.com



Chartplotters
Fishfinders
Sonar & Radar
Trolling Motors
lowrance.com



Batteries
Power Conversion
mastervolt.us



What makes Marlinco different:

Founder's Vision

Since 1972, Marlinco power inlets and cords have set the industry standard. They are built to withstand the harshest marine environments. Marlinco has continued to expand their product line to offer a complete range of shore power cords from 16A to 100A, as well as a broad range of cord adapters. Marlinco is also a leading supplier of wipers, spotlights and horns to the marine industry.

Innovation & Engineering

Marlinco engineers and manufactures a range of high quality electrical solutions designed for the harsh Marine and RV environments. Every product we make meets exacting performance specifications and is designed to withstand extreme conditions both at sea, and on land.

Selection

Over 800 electrical products are designed to work together as a system

Worldwide Access to Product

A distribution network in over 45 countries provides access to products when they are needed

Information

24-hour access to product information, selection tools, and technical articles online at marinco.com

Industry Standards

Industry involvement ensures products meet ABYC, NMMA, and Coast Guard standards

Quality

Product quality is managed in a manner consistent with international standards

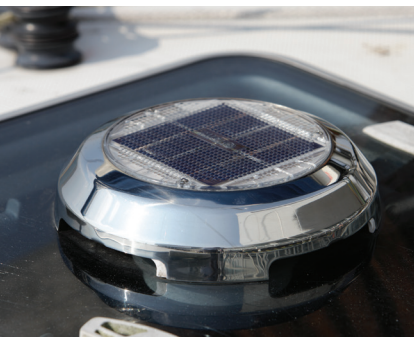

Table of Contents

Shore Power

Dock Side to Boat Side Selection Guide	8
Inlets	10
Cordsets	16
Extension Cords	18
Adapters	20
Devices & Accessories	27
Boxes / Covers / Replacement Parts	32
16A Shore Power Systems	33
32A Shore Power Systems	34
63A Shore Power Systems	35
100A Shore Power Systems	36



DC Power Connections

12V Receptacles / Plugs / Accessories	41
USB Chargers	43
Charging / Trolling Systems	44



Power Conversion

On-Board Battery Chargers	50
Maintainer	52
Portable Battery Chargers	53
Battery Charger Accessories	54



Battery Management

Dynaplates	58
Battery Switches	59



Wiper Systems

Wiper Motors	64
Wiper Motors Kits	71
Wiper Arms	72
Wiper Blades	74
Wiper System Accessories	77



Horns

Hidden Horns	81
Compact Horns	85
Trumpet Horns	86

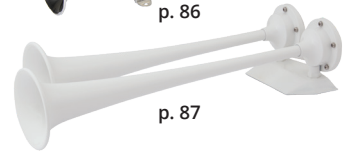

Lighting

Spot Lights	90
Deck Lamps	93
Docking Lights	93



Ventilation

Solar Vents	98
Cowl & Clam Shell Vents	100
Deck Plates	101
Fans	102



Index

Part Number Index	103
-------------------	-----

SHORE POWER

Inlets



10

Marinco® power inlets are the industry standard. Offered in three styles, featuring robust construction and corrosion-resistant materials for long life in the harsh marine environment. All inlets have an IP56 rating.

Cordsets



16

All Marinco® cordsets are made of the highest quality, marine grade construction with features you won't find on other power cords.

15A Marine Grade Locking Extension Cords

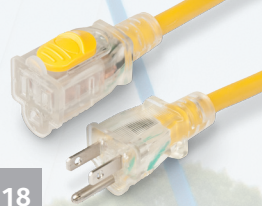

18

15A extension cords contain a universal slide locking mechanism to prevent cable disconnection. Available in 25' and 50' lengths.

Cordset Accessories



19

Marinco offers everything you need to manage your shore power equipment.

SHORE POWER

Adapters

20

Marinco® Shore Power Adapters give you more power hook-up flexibility and resolve a variety of dock side power center / boat side inlet power incompatibility problems.



Devices & Accessories

27

Everything you need to maintain and repair your shore power equipment.



International Shore Power

33

Marinco offers inlets, connectors and cordsets for 16A, 32A and 63A Shore Power systems.



100 Amp Shore Power

36

Marinco 100A cordsets are for use with or without on-board isolation transformers, as male plug only power supply, and extension cord applications. Constructed with watertight and corrosion resistant plugs and connectors, and oil, water, and UV resistant cable, rated to 221°F (105°C).



Marinco® power inlets and cords have been the industry standard and are designed and built to withstand the rigors of the marine environment.

Marinco® Dock Side to Boat Side Selection Guide

DOCK SIDE

Marine Receptacles
(pg 27-31)
Corrosion resistant reinforced nylon construction.

Weatherproof Covers
(pg 32)
Yellow LEXAN® polycarbonate with lift lid, for use with Marinco® receptacles.

Male Plugs
(pg 27-31)
Superior strain-relief system. Dust seal keeps contaminants out of terminals.

Weatherproof Covers
(pg 27-31)
Heavy-duty vinyl construction, use with male plugs for superior seal.

30A
125V
2-Pole
3-Wire
Locking

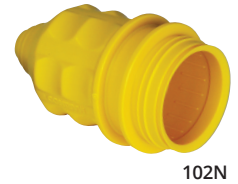

50A
125V
2-Pole
3-Wire
Locking



50A
125/250V
2-Pole
4-Wire
Locking



**Cable TV/
Internet**



Marinco® Color Coding System

15A 125V	20A 125V	30A 125V	50A 125V	50A 125/250V	Cable TV Internet
--------------------	--------------------	--------------------	--------------------	------------------------	------------------------------

BOAT SIDE

Shore Power Cord Sets

(pg 16-17)

Marine grade cable, watertight molded plug and connector, line-up ridge for easy blade alignment.

Weatherproof Covers

(pg 27-31)

Heavy-duty vinyl construction, use with female connector for superior seal.

Female Connectors

(pg 27-31)

Ribbed nylon construction, color coded terminal pockets and screws.

Power Inlets

(pg 11-13, 18)

Styled to complement any boat, Marinc® power inlets are simple to install and feature a protective rear safety enclosure that provides safe, reliable strain relief. IP56 rated (see inside back cover).



CS30-50



103ELN



305CRCN



CS503-50



7715CRN



6360CRN



CS504-50



7715CRN



6364CRN

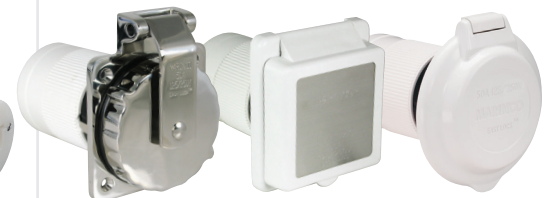

TVHD



PH6629



Inlets

Marinco® power inlets are the industry standard. Offered in three styles, they all feature robust construction and corrosion-resistant materials for long life in the harsh marine environment. Each has technical features that make them easy to install and a pleasure to use for the marine professional or the casual recreational boater. All inlets have an IP56 rating (see inside back cover).



Stainless Steel

Marinco stainless steel inlets are solid cast marine grade 316 stainless steel and include a heavy duty cap strap for strength and durability.



Contoured

Marinco contoured inlets feature UV stabilized glass-filled polyester construction for long-lasting strength.



Standard

Marinco standard inlets feature UV stabilized glass-filled polyester construction for long-lasting strength.

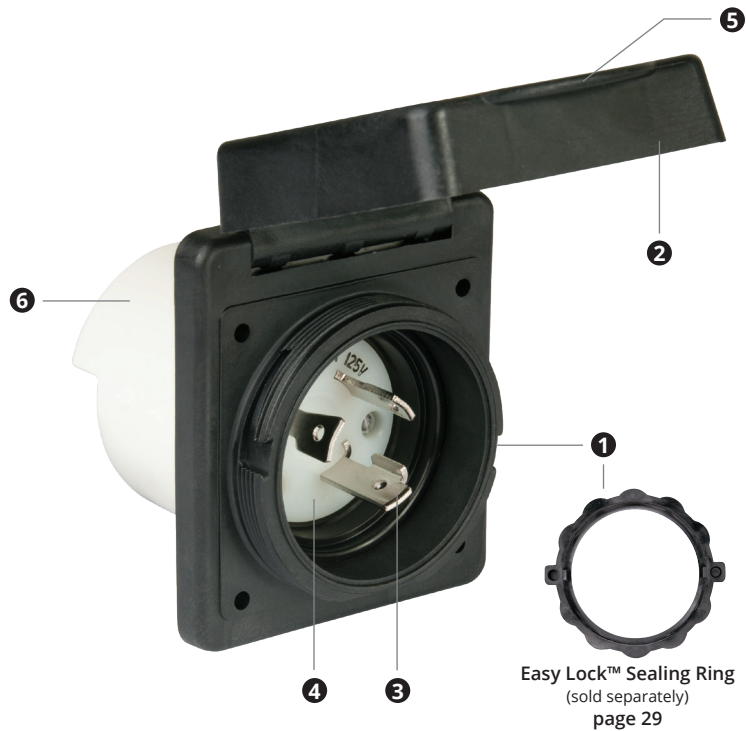

- 1 Easy Lock™—Marinco's exclusive Easy Lock System has been designed to connect the cordset (with an Easy Lock sealing ring installed) to the inlet and turn the locking ring less than a quarter turn. The tabs on the locking ring lock into the inlet for a positive watertight hook-up while eliminating any chance of cross threading. Easy Lock inlets have a threaded boss that will accept standard threaded cordsets as well.
- 2 The covers on all Marinco inlets are designed to stay hinged open when the cover is lifted up. This allows the boater to connect their shore power cord while the cover remains open and out of the way. A soft touch unlocks it for closing.
- 3 Blades are nickel plated brass for maximum corrosion resistance.
- 4 Interior hardware is marine grade stainless steel.
- 5 **IMPROVED** Extra large tab provides more area to simplify opening and closing.
- 6 **Rear Enclosure**
 - Made of flame-resistant UL 94V0 plastic.
 - All rear enclosures are glass-filled polyester for strength.
 - Integral strain relief complies with ABYC requirements.
 - Multiple positions allow for maximum installation flexibility.

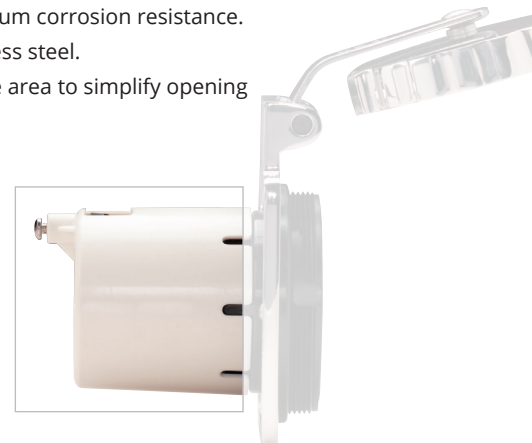

30A
125V

30 Amp 125V Inlets

IP56
See inside back cover

NEMA L5-30P  30A 125V Locking

Meets or Exceeds
ABYC
Standards



Stainless Steel Power Inlet

- Cast 316 stainless steel
- Part # 303SSEL-B
OEM # 303SSEL-B.OEM



Contour Power Inlet

- Stainless steel trim
- Part # 304EL-B
OEM # 304EL-B.OEM



Contour Power Inlet

- Without stainless steel trim
- OEM # 304EL-B.NT white
OEM # 199136 black



Power Inlet

- Stainless steel trim
- Part # 301EL-B white
OEM # 301EL-B.OEM white
Part # 301ELCB replacement cap & bezel

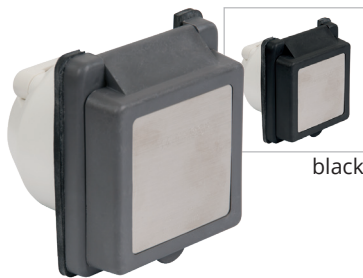

Power Inlet

- Stainless steel trim
- Part # 301EL-B.GRAY gray
Part # 301EL-B.BLACK black



Power Inlet

- ABYC shore power warning label on cap
- Part # 301EL-B.W/L



Power Inlet

- Stainless steel trim
 - Hole in rear enclosure accommodates snap-in strain relief (not included)
- Part # 301EL-B.FR



Breaker Inlet

- Includes cap & bezel and breaker plate
 - Breaker not included
- Part # 3050BI



Stainless Steel Power Outlet

- Female 30A 125V configuration
 - NEMA configuration L5-30R
- Part # 303SSO

50A
125V **50 Amp 125V Inlets**

IP56
See inside back cover

NEMA
SS1-50P



W 50A
125V
Locking

Meets or Exceeds
ABYC
Standards



Stainless Steel Power Inlet

- Cast 316 stainless steel

Part # 6371EL-B
OEM # 6371EL-B.OEM



Stainless Steel Power Inlet

- Cast 316 stainless steel
- Without rear safety enclosure

Part # 6371EL



Power Inlet

- Stainless steel trim
- Without rear safety enclosure

Part # 6351EL



Power Inlet

- Without stainless steel trim
- ABYC shore power warning label on cap

Part # 6351EL-B

TECH TIP

50A Devices Explained

There are two categories of 50A devices: 50A 125V (50A 3-wire) and 50A 125/250V (50A 4-wire). The 4-wire devices have two "hot" legs, each carrying 50A 125V. These two categories are not interchangeable. A 3-wire plug must never be altered to insert into a 4-wire connector or receptacle.



50A
125/250V

50 Amp 125/250V Inlets

IP56
See inside back cover

NEMA
SS2-50P
Y
G
W
X 50A
125/250V
Locking

Meets or Exceeds
ABYC
Standards

SP
MARINE
UL LISTED



Stainless Steel Power Inlet

- Cast 316 stainless steel

Part # 6373EL-B
OEM # 6373EL-B.OEM
Part # 6373EL-B.W/L w/separate warning label



Stainless Steel Power Inlet

- Cast 316 stainless steel
- Without rear safety enclosure

Part # 6373EL
OEM # 6373EL.OEM



Contour Power Inlet

- Without stainless steel trim

Part # 6344EL-B.NT



Power Inlet

- Stainless steel trim

Part # 6353EL-B
OEM # 6353EL-B.OEM
Part # 6353ELCB replacement cap & bezel



Power Inlet

- Stainless steel trim
- Black

OEM # 6353EL-B.BLACK.OEM



Power Inlet

- Stainless steel trim
- Gray

Part # 6353EL-B.GRAY



Power Inlet

- Stainless steel trim
- Without rear safety enclosure

Part # 6353EL

ELCI Inlets

Marinco®'s solution to the ABYC E-11 requirement is based on our industry-standard marine inlets. We have taken the best available technology and built it into our inlets to provide boat builders and owners with the safest, best looking and most durable solution possible. All of our ELCI Inlets are ignition protected to comply with ABYC standards.

We provide two modules in addition to the standard inlet. One houses the ELCI Marine Sensing Module, the other the breaker. Unlike competing systems, our ELCI Marine sensing module has a 3/4" diameter coil that accepts up to three 6-gauge conductors. This sensing module, which also incorporates a test circuit, is compatible with 30A 125V, 50A 125V and 50A 125/250V systems. There is a different breaker for 30A and 50A systems.

TECH TIP

ELCI ABYC Standards

Electrical current leakage is a serious safety concern for any boat connected to shore power. Because of this ABYC requirements now include specific measures for avoiding this danger. ABYC E-11.11.1 states "An Equipment Leakage Circuit Interrupter (ELCI) shall be installed with or in addition to the main shore power disconnect circuit breaker(s) or at the additional overcurrent protection as required by E-11.10.2.8.3 whichever is closer to the shore power connection."

Single Phase 120V AC 30A (Hot, Neutral, Ground)

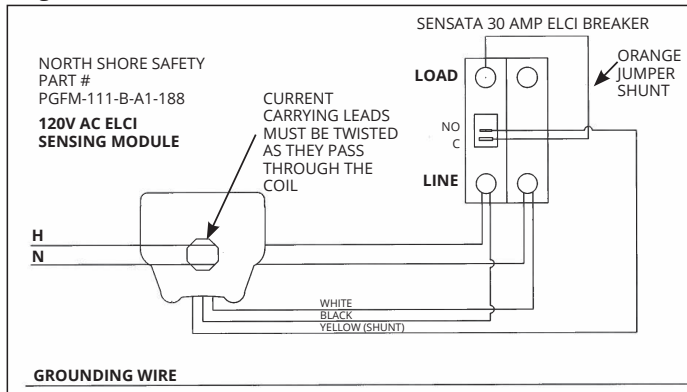

Split Phase 120/240V AC 50A (Line 1, Line 2, Neutral, Ground)

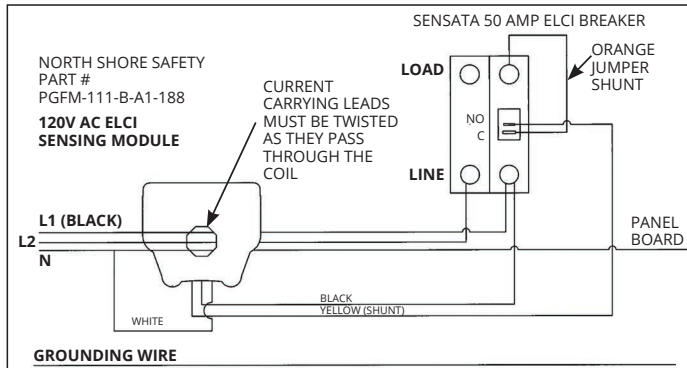

Standard Sensing Breaker & Module Kits

- Module & breaker packaged together

30A 120V AC Single Phase OEM # 301RCDKITIGN.OEM
 50A 120/240V AC Split Phase OEM # 6353RCDKITIGN.OEM



Stainless Steel Housing for Sensing Modules

- Cast 316 stainless steel
- OEM # 303SSRCDPL.OEM

Stainless Steel Housing for 30A or 50A Sensing Breakers

- Cast 316 stainless steel
- OEM # 303SSBKRPL.OEM



Standard Housing for Sensing Modules

OEM # 301RCDPL.OEM

Standard Housing for 30A or 50A Sensing Breakers

OEM # 301BKRPL.OEM



Cable TV / Internet



Stainless Steel Phone & Cable TV Inlet

- Cast 316 stainless steel
- Part # PH6592TV-SS
OEM # PH6592TV-SS.OEM



Phone & Cable TV Inlet

- Stainless steel trim
- Part # PH6574TV
Part # PH6574TV.W/L w/ warning label



Stainless Steel Cable TV / Internet Inlet

- Cast 316 stainless steel
- Part # TV6592
OEM # TV6592.OEM



Cable TV / Internet Inlet

Part # TV6574



Contour Cable TV / Internet Inlet

Part # TV6444





EEL Shore Power Cordsets

One Hand. A Simple Twist. Full Power.

The EEL (Easily Engaged Lock) Shore Power Cordset has a patented, industry first, jaw-clamp design providing one-handed operation and a secure waterproof seal which completely eliminates the need for a locking ring. The EEL connection is built for the harshest environments and is UL approved. This easy-to-use cordset features a built-in cord light which serves as an alert to boaters when the cord is left plugged in. And, best of all, it works with your current inlet. In addition to cordsets with the EEL System, Marinco® also has a full set of Pigtail and Y adapters all using the new EEL technology.

Patented EEL Technology:

- Designed for use with standard inlets (NEMA)
- Single-handed operation
- No sealing ring required
- Patented jaw-clamp technology provides a watertight seal every time

Features & Benefits:

- Built-in cord light for added safety – alert light indicates if you are plugged into the dock and cord is powered
- Power indicator light on both ends informs you full power is flowing through the cord
- Meets and exceeds rigorous UL testing standards
- 30A and 50A cordset models, 12', 25' and 50' lengths in white and yellow available
- EEL product line includes connectors, pigtail, straight and “Y” adapters



5 YEAR WARRANTY



Length	Color	Part #
30A 125V Cordsets		
12'	yellow	CS30-12
25'	yellow	CS30-25
50'	yellow	CS30-50
50'	white	CS30-50W
50A 125V Cordsets		
25'	yellow	CS503-25
50'	yellow	CS503-50
50A 125/250V Cordsets		
25'	yellow	CS504-25
50'	yellow	CS504-50
50'	white	CS504-50W



NEMA L5-30R
30A 125V Locking



NEMA SS1-50R
50A 125V Locking



NEMA SS2-50R
50A 125/250V Locking

Amp	Volts	Plug	Connector
30A	125V AC	L5-30P	L5-30R
50A	125V AC	SS1-50P	SS1-50R
50A	125/250V AC	SS2-50P	SS2-50R



CS504-50W

CS30-50

TECH TIP

Blade Function Letter Codes

- G** Ground
- X** Phase 1 Hot
- W** Neutral
- Y** Phase 2 Hot

Power Cord Plus® Cordsets

All Marinco® cordsets are made of the highest quality, marine grade construction with features you won't find on other power cords.

- 1 Watertight molded plug and connector for safety and durability
- 2 Heavy-duty, super flexible marine grade cable (30A 10-gauge, 50A 6-gauge)
- 3 All models include a standard threaded ring for hook-up to ordinary threaded inlets
- 4 Corrosion resistant, nickel plated contacts
- 5 Power Indicator Light: Boat side connector features a molded-in LED light. When it glows red, you know you have power to the boat.
- 6 Contour Grip with Thumbprint Locator: Both plug and connector ends are molded to fit the contour of your hand. When the thumbprint is in the 12 o'clock position, the blades line up for easy connection.
- 7 Marinco's Easy Lock™ system: Quickly locks the cord set to the inlet in just 1/8 of a turn. The exclusive locking tabs engage slots built into all Marinco inlets (sold separately).



Easy Lock™ system



5 YEAR WARRANTY



Length	Color	Pkg	Part #	OEM #
30A Power Cord Plus® Cordsets				
12'	yellow	sleeve pack	199116	—
25'	yellow	sleeve pack	199117	—
25'	white	sleeve pack	25SPPW	—
25'	gray	sleeve pack	199117G	—
35'	yellow	sleeve pack	35SPP	—
50'	yellow	sleeve pack	199119	50SPP.OEM
50'	white	sleeve pack	199120	50SPPW.OEM
50'	gray	sleeve pack	199119G	—
75'	yellow	box	—	75SPP.OEM
50A 125V Power Cord Plus® Cordsets (3-Wire)				
25'	yellow	box	6153SPP-25	—
50'	yellow	box	6153SPP	—
50'	white	box	6153SPPW	—
75'	yellow	box	6153SPP-75	—
50A 125/250V PowerCord Plus® Cordsets (4-Wire)				
12'	yellow	box	6152SPP-12SC	—
25'	yellow	box	6152SPP-25	—
25'	white	box	6152SPPW-25	—
25'	gray	box	6152SPPG-25	—
50'	yellow	box	6152SPP	—
50'	white	box	6152SPPW	—
50'	gray	box	6152SPPG	—
75'	yellow	box	6152SPP-75	—
50A Plug End Only Cordsets				
55'	white	box	6152SPPW-55.P/O	—
75'	white	box	6152SPPW-75.P/O	—



15A Marine Grade Extension Cords

- Marine grade SJTOW cable
- Clear ends with lighted female end for visual power indication on 14/3 models
- Female end contains slide button lock for protection against cable disconnection*
- Slide button lock compatible with all other manufacturers' products*
- ETL certified to UL standards

Cable	Length	Description	Part #
14/3	25'	Locking and Lighted	150025
	50'	Locking and Lighted	150050
	25'	Lighted	150025NL
	50'	Lighted	150050NL
12/3	25'	Heavy-duty	151225
	50'	Heavy-duty	151250

*150025 and 150050 models only

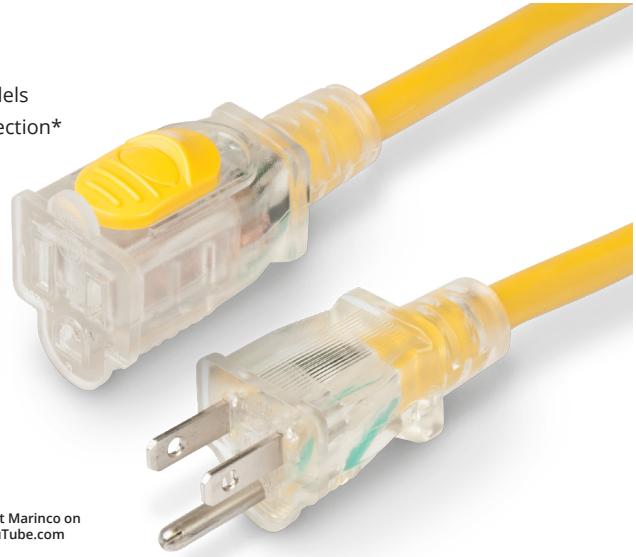
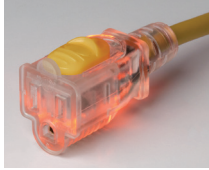

LEARN MORE
Extension Cords
Video



Visit Maritco on
YouTube.com



Cable TV/Internet

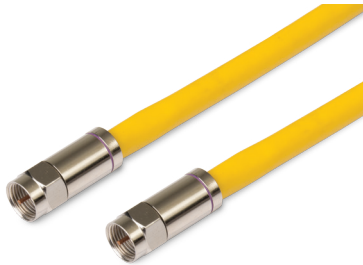

HDTV / Internet Cable

- 50' yellow cable
- 75 ohm, 3G Hz RG6 Quad Shield cable with gasket sealed
- Weatherproof F-type connections on both ends

Part # TVHD



Combo TV/Phone Cordset

- Both cables are jacketed together
- Telephone and TV connections are molded on each end
- Features 18" of spliced cable at dock side for connections which are in separate power centers

Part # PHTV6599 50'



Telephone Cordset

- 3 conductor 16 AWG SJTO vinyl cord provides portable telephone connection for RV's and pleasure boats

Part # PH6599 50'



TV Cable Cordset

- Standard 75 ohm, RG59-U with quick, slip-on connections and heavy duty boots included on both ends

Part # TV99-25 25' yellow
Part # TV99W 50' white



Cable TV Outlet

- Spring-loaded lift cover
- Weatherproof closure
- Fits FS & FD boxes

OEM # TV97.OEM



Telephone & Cable TV Outlet

- Spring-loaded lift cover
- Fits FS & FD boxes

OEM # PH6597TV

Cordset Accessories



Cord Clips

- Includes six cord clips with stainless steel mounting screws
- Keeps shore power cable out of the water
- Holds 10-gauge 30A cable
- Easy to install
- Use on deck or edge of dock
- Organize shore power cable

Part # CLIP

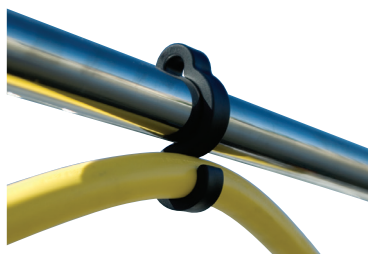

Railmount Cord Clips

- For 30A cords
- Organize shore power cords quickly and easily
- Can be used on tube or wire rails
- Packaged as set of 6 clips
- UV stable
- Practically unbreakable

Part # CLIP-01 black



Organizer Bag

- Heavy-duty nylon zippered bag with handle
- Ideal for storing cordsets and adapters
- Dimensions 20" x 15" x 8"

Part # BAG

Cord Cover

- Keep shore power cables neat and bundled
- Holds 50A or 30A cordsets, can hold multiple cables
- UV resistant, machine washable marine grade fabric
- 24'

Part # CCVR-24 black



Carrying Strap

Bundle and organize your shore power cables or hoses with this durable and flexible nylon carrying strap. Its adjustable design fits around cordsets or hoses up to 9" in diameter while, the ergonomic, rubber handle makes carrying even larger 50A cord sets easy on your hand. A metal, reinforced grommet allows for hanging and storage.

Part # STRAP



Adapters

The Marinc® Shore Power Adapters give you more power hook-up flexibility and resolve a variety of dock side power center / boat side inlet power incompatibility problems.

TECH TIP

Choosing the Correct Adapter

Step 1: Boat Side – Identify Your Boat's Inlet Electrical System



The voltage and amperage should be printed on the outside cover of your existing boat inlet(s)



The voltage and amperage should be printed inside the boat Inlet(s) next to the blades

30A 125V



50A 125V

Check the blade orientation of the various inlets pictured and compare to your boat inlet(s)



50A 125/250V

Pay special attention to the differences in the 50A 125V and the 50A 125/250V. The blades look similar, but they are different. The plugs and receptacles for these systems are NOT interchangeable!!

Notice the additional grounding blade on the 50A 125/250V inlets.

IMPORTANT 50 AMP INFORMATION: If you are connecting to 50A dock side power service, it is CRITICAL to know the dock side receptacle's voltage rating (50A 125V or 50A 125/250V). An adapter designed for 50A 125V will not plug into a dock side receptacle rated for 50A 125/250V service, and vice versa.

Step 2: Identify the Dock Side Power Source



NEMA L5-20R
20A 125V
Locking



NEMA L5-30R
30A 125V
Locking



NEMA L5-15R
15A 125V
Straight Blade



NEMA SS1-50R
50A 125V
Locking



NEMA SS2-50R
50A 125/250V
Locking

Step 3: Choose a Marinc Adapter From page 21–26

Match your boat side inlet(s) to the appropriate dock side receptacle or other power source. Adapter ends are color coded for easier selection.

Types of Adapters



Straight Adapters are high-quality, one-piece adapters similar in usage to Pigtail Adapters. However, they do not have sealing collars and are not recommended for use in wet locations. Use only in an enclosed, dry location, such as powering your boat from a 15A power receptacle inside your house.

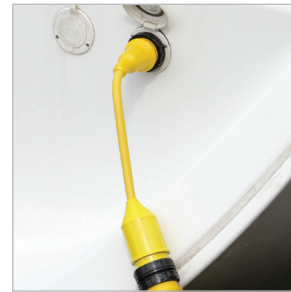

Pigtail Adapters* allow you to connect from one dock side receptacle (or other power source receptacle) to one boat side inlet or equipment of dissimilar power configuration. These adapters are fully molded and equipped with Marinc's unique sealing collar (where indicated) and covers for use in wet locations.



"Y" Adapters* let you split one dock side receptacle between two boat inlets of similar or dissimilar power configurations. "Y" adapters are fully molded and equipped with Marinc's unique sealing collar and covers (where indicated) for use in wet locations.

The Reverse "Y" Adapter (Part # RY504-2-30) The reverse "Y" provides 50A 125/250V power when only two 30A 125V receptacles are available.

*Available with standard locking rings or with the new EEL quick locking system

Straight Adapters

Not recommended for use in wet locations.
Includes power LED.

Part #

S20-15
Replaces the 80A.



S30-15
Replaces the 81A.



S15-30
Replaces the 83A.



S20-30
Replaces the 84A.



S15-504



DOCK SIDE

MALE PLUG
Attaches to dock side receptacle or cordset



BOAT SIDE

FEMALE CONNECTOR
Attaches to boat inlet or cordset



EEL Pigtail Adapters

These adapters are equipped with sealing collars and are for use in wet locations.



Part #

- P15-30 
- P15-30-25 25'
- P15-30-25W 25', white



P30-15



P30-503



P30-504



P503-30



P504-30



P504-503



DOCK SIDE

MALE PLUG

Attaches to dockside receptacle or cordset

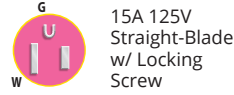

BOAT SIDE

FEMALE CONNECTOR

Attaches to boat inlet or cordset

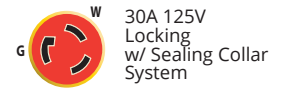
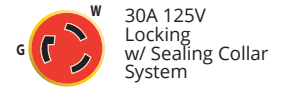
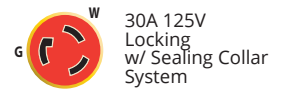

Related Products



Sealing Rings
page 27-29

Pigtail Adapters

These adapters are equipped with covers and sealing collars (where indicated), and are for use in wet locations.

Part #
 104SPP 
 104SPPG gray
 104SPP.OEM
 104SPP-25.OEM 25'
 104SPP-50.OEM 50'

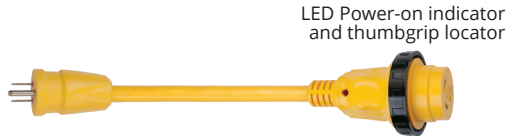

LED Power-on indicator and thumbgrip locator

115A



LED Power-on indicator and thumbgrip locator

150SPP



LED Power-on indicator and thumbgrip locator

106A



LED Power-on indicator and thumbgrip locator

105SPP
 105SPPG gray



LED Power-on indicator and thumbgrip locator

111A



LED Power-on indicator and thumbgrip locator

117A



110A



LED Power-on indicator and thumbgrip locator

118A



121A



LED Power-on indicator and thumbgrip locator

123A





DOCK SIDE

MALE PLUG
 Attaches to dockside receptacle or cordset

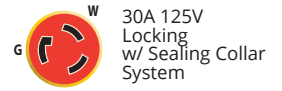
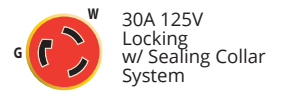
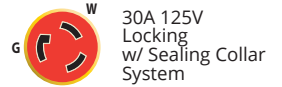

BOAT SIDE

FEMALE CONNECTOR
 Attaches to boat inlet or cordset



EEL "Y" Adapters

These adapters are equipped with sealing collars and are for use in wet locations.

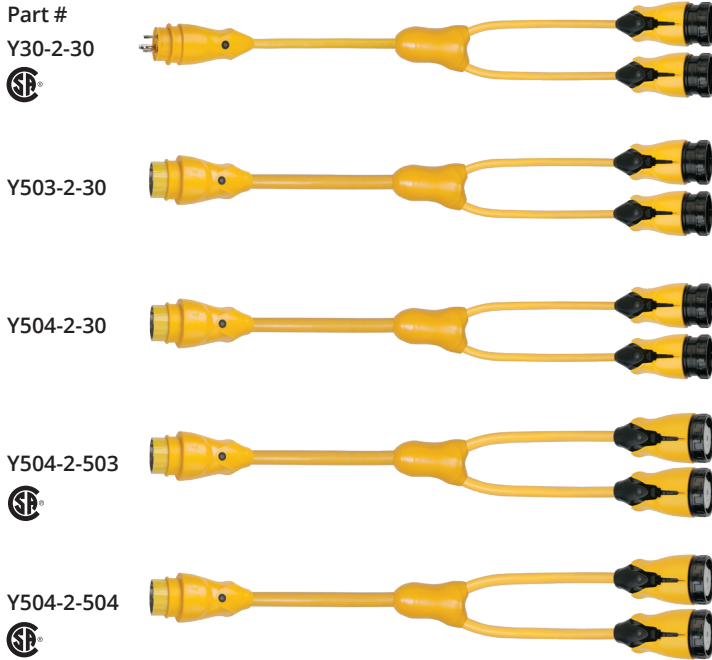

DOCK SIDE

MALE PLUG
Attaches to dock side receptacle or cordset

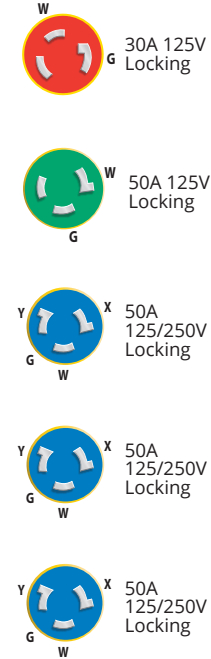

BOAT SIDE

FEMALE CONNECTOR
Attaches to boat inlet or cordset

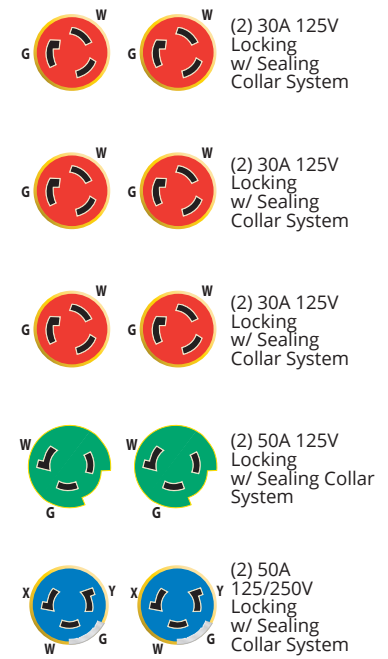

"Y" Adapters

These adapters are equipped with covers and sealing collars (where indicated), and are for use in wet locations.



DOCK SIDE

MALE PLUG
Attaches to dock side receptacle or cordset

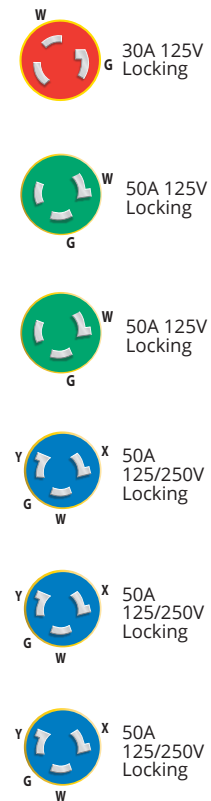

BOAT SIDE

FEMALE CONNECTOR
Attaches to boat inlet or cordset

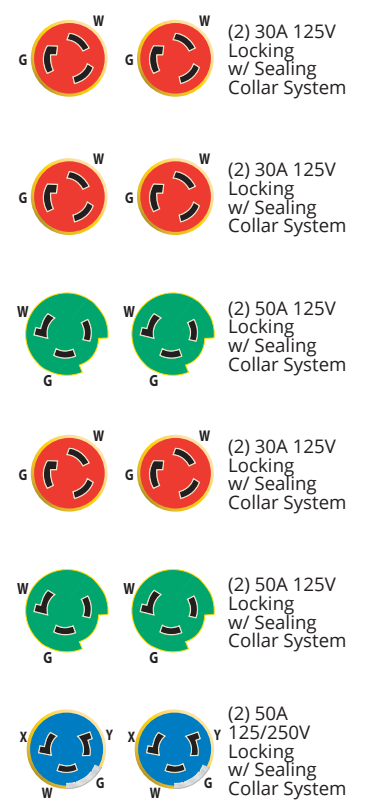

Reverse “Y” Adapter

The Reverse “Y” Adapter has two (2) male plugs with special power isolation circuitry for added safety. When one (1) plug is connected to a receptacle, the circuitry isolates the second plug. The reverse “Y” provides 50A 125/250V power when only two (2) 30A 125V receptacles are available.

Note: Reverse “Y” will NOT work with 50A, 125V, 3-wire inlets. Power is provided in both circuits to the 4-wire inlet, but the dock side receptacles limit the current in each circuit to 30A. The two (2) 30A 125V receptacles must be supplied from a single power source providing 208V to 250V between them for proper operation.

Part #
RY504-2-30



DOCK SIDE

MALE PLUG
Attaches to dock side receptacle or cordset



BOAT SIDE

FEMALE CONNECTOR
Attaches to boat inlet or cordset

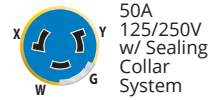

Marine Surge & Safety Pigtails

Detect faulty pedestal wiring conditions before they damage your equipment.

Faulty and unsafe shorepower can damage your sensitive electronics. These new pigtail adapters not only detect defective wiring at the pedestal, but also protect against electrical surges. Integrated LEDs provide visual indication of several unsafe conditions such as open ground, open neutral, and reverse polarity. Built-in surge protection with indicator that alerts that the adapter has been compromised.

- Ergonomic 90 degree (right angle) dockside plug
- Boat side connectors feature locking sealing collar system
- Bright 3-color LED electrical status indicators
- Surge failure indicator
- Surge protection ratings:
30A: 825 joules
50A: 1650 joules

Part #
1RPCSP
(30A)



DOCK SIDE

MALE PLUG
Attaches to dock side receptacle or cordset



BOAT SIDE

FEMALE CONNECTOR
Attaches to boat inlet or cordset

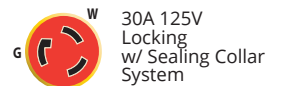

1RPC50SP
(50A)











Related Products





Cordsets
page 17

Right Angle Adapters

		DOCK SIDE	BOAT SIDE
		MALE PLUG Attaches to dock side receptacle or cordset	FEMALE CONNECTOR Attaches to boat inlet or cordset
<p>Part #</p> <p>1RPC (30A)</p> 		<p style="text-align: center;">W 30A 125V G Locking</p> 	<p style="text-align: center;">W 30A 125V G Locking w/ Sealing Collar System</p> 
<p>Part #</p> <p>1RPC50 (50A)</p> 		<p style="text-align: center;">Y 50A 125/250V G Locking W</p> 	<p style="text-align: center;">X 50A 125/250V G Locking w/ W Sealing Collar System</p> 

Dock Side 30A to 15A Adapter with GFCI

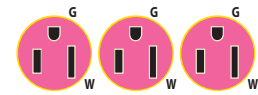
<p>Part #</p> <p>199128</p> 	DOCK SIDE	BOAT SIDE
	MALE PLUG Attaches to dock side receptacle or cordset	FEMALE CONNECTOR Attaches to boat inlet or cordset
	<p style="text-align: center;">W 30A 125V G Locking</p> 	<p style="text-align: center;">G (3) 15A 125V W Straight Blade</p> 

- Provides safer hook-up to 30A dock side power
- Provides protection against harmful electric shock
- Reduces the possibility of fire
- Offers protection for up to three (3) attached tools
- Corrosion resistant and rain-proof rated for outdoor use
- GFI trip level of 4-6 mA
- Can also be used for other outdoor, harsh environments such as construction sites or wherever ground fault protection is desired

Note: A Ground Fault Circuit Interrupter (GFCI) limits the duration of an electrical shock to a period considered safe for healthy people. It does not prevent electric shock. This device does not protect against electric shock due to contact with both circuit conductors or a fault in any wiring supplying this device.

TECH TIP

GFCI Protection

According to ABYC standard E-11.11. A Ground Fault Circuit Interrupter (GFCI) may be used on single phase AC circuits to provide additional protection for personnel and equipment.

30A
125V

30A 125V Devices & Accessories



Male Plug

Part # 305CRPN
OEM # 305CRPN.OEM



Female Connector

Part # 305CRCN
OEM # 305CRCN.OEM



Male Plug & Cover

• Weather resistant cover
Part # 305CRPN.VPK



Female Connector w/ Cover

• Weather resistant cover
Part # 305CRCN.VPK



Locking Receptacle

• Corrosion resistant
• Reinforced nylon construction
• Yellow
Part # 305CRR



Locking Receptacle

• Corrosion resistant
• Reinforced nylon construction
• Black
Part # 305CRRB
OEM # 305CRRB.OEM



Weatherproof Cover w/ Threaded Sealing Ring

• Use with 305CRCN or 205CRCN
Part # 103RN
OEM # 103RN.OEM



Weatherproof Cover w/ Easy Lock™ Sealing Ring

• Use with 305CRCN or 205CRCN
Part # 103ELN



Weatherproof Cover

• Use with 305CRPN or 205CRPN
Part # 102N



Easy Lock™ Sealing Ring

• Use with 30A Marinco® Inlets
Part # 100EL



Threaded Sealing Ring

• Use with 30A systems
Part # 100R



Sealing Collar w/ Threaded Ring

• Provides maximum moisture protection between cordset & adapter
• Use with 20A & 30A locking systems
Part # 110R

50A
125V**50A 125V Devices & Accessories****Male Plug**

- 2-pole, 3-wire

Part # 6361CRN

**Female Connector**

- 2-pole, 3-wire

Part # 6360CRN
OEM # 6360CRN.OEM**Wire Dock Side Receptacle**

- 2-pole, 3-wire

Part # 6370CR

50A
125/250V**50A 125/250V Devices & Accessories****Male Plug**

- 3-pole, 4-wire

Part # 6365CRN
OEM # 6365CRN.OEM**Female Connector**

- 3-pole, 4-wire

Part # 6364CRN
OEM # 6364CRN.OEM**Wire Dock Side Receptacle**

- 3-pole, 4-wire

Part # 6369CR
OEM # 6369CR.OEM

50A Accessories

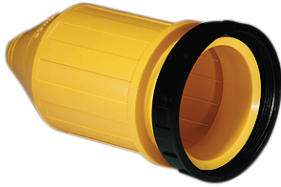

Weatherproof Cover w/ Threaded Sealing Ring

- Use with 6360CRN or 6364CRN

Part # 7715CRN
OEM # 7715CRN.OEM



Weatherproof Cover w/ Easy Lock™ Sealing Ring

- Use with 6360CRN or 6364CRN

Part # 7715ELN
OEM # 7715ELN.OEM

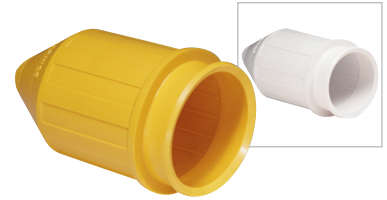

Weatherproof Cover

- Use with 6361CRN or 6365CRN
- Can be used on both male & female ends

Part # 7717N	yellow
OEM # 7717N.OEM	yellow
Part # 102182	white



Easy Lock™ Sealing Ring

- Use with 50A Marinco® Inlets

Part # 500EL



Threaded Locking Sealing Ring

- Use with 50A systems

Part # 500R



Sealing Collar w/ Threaded Ring

- Provides maximum moisture protection between cordset & adapter
- Use with 50A only systems

Part # 510R



Universal Watertight Connector Cap

- For use on 16A or 32A products for CE compliance
- For use on 30A or 50A products to protect the connector when not in use

Part # 199111PK 16A/30A/32A/50A/63A



Watertight Connector Cap

- For use on 16A or 32A products for CE compliance
- For use on 30A or 50A products to protect the connector when not in use

Part # 199109PK	16A/30A
Part # 199110PK	32A/50A

15A
125V **15A125V Devices & Accessories**



Male Plug
• Straight blade
Part # 5266CR



Female Connector
• Straight blade
Part # 5269CR



Male Plug
• Locking type
Part # 4721CR



Female Connector
• Locking type
Part # 4731CR



Duplex Locking Receptacle
• Yellow
Part # 4700CR



Duplex Straight Receptacle
Part # 5262CRR yellow
Part # 5262CRR.GRY gray

Ground Fault Circuit Interrupter (GFCI)

CAUTION: Ground Fault Circuit Interrupter protection is required when using electrical products outdoors or near water. GFCI Protection is required by the ABYC where a receptacle is in a head, galley, machinery space or weather deck.

- Part # 1591-FI ivory
- Part # 1591-FI.WHITE white
- OEM # 1591-FI.GRY.OEM gray



20A
125V

20A 125V Devices & Accessories



Male Plug

- Straight blade

Part # 5366CR



Female Connector

- Straight blade

Part # 5369CR
OEM # 5369CR.OEM



Male Plug

- Locking type
- Uses weatherproof cover 102N

Part # 205CRPN



Female Connector

- Locking type
- Uses weatherproof cover 103RN

Part # 205CRCN



Locking Receptacle

Part # 205CRR

15 & 20 Amp Accessories



Weatherproof Cover

- Use with 5366CR or 5266CR plugs

Part # 6017



Weatherproof Cover

- Use with 5369CR or 5269CR connectors

Part # 6018



Weatherproof Cover

- Can be used on 15A & 20A

OEM # 1520BI.OEM

Boxes / Covers / Replacement Parts



FS Box

- Black non-metallic, with two 3/4" K.O. holes
- Accepts 15A, 20A & 30A receptacles, and 7420CR weatherproof covers

Part # 6080

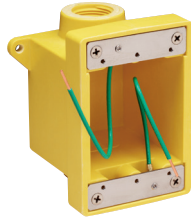

FD Box with 3/4" or 1" K.O. Holes

- Yellow fiberglass, with two K.O. holes
- Accepts 15A, 20A, 30A & 50A receptacles, and 7420CR & 7788CR covers

Part # 6083CR 3/4" holes

Part # 6084CR 1" holes



Weatherproof Cover

- Yellow LEXAN® polycarbonate with lift lid
- Fits 15A, 20A, & 30A single receptacles

Part # 7420CR

OEM # 7420CR.OEM

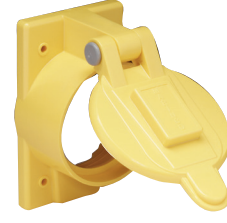

Weatherproof Cover

- Yellow LEXAN® polycarbonate with lift lid
- Fits 50A receptacles 6369CR & 6370CR

Part # 7788CR

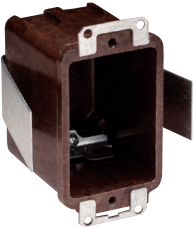

Plastic Switch/Outlet Box

- 3-9/32" x 2-3/16" x 2-1/2" D
- Can be secured against the back of wall or wall facing
- Accepts 15A, 20A & 30A receptacles, telephone outlets and TV coax connectors

Part # 6079



302 Stainless Steel Sealed Cover with Lift Lid

- Fits 4700CR, 5262CRR, & 5739CR duplex receptacles

Part # 7879CR



302 Stainless Steel Sealed Cover with Lift Lid

- Fits GFCI duplex receptacles

Part # 7879CR-FI

OEM # 7879CR-FI.OEM



Replacement Interior

- Fits 50A 125/250V Easy Lock 4-wire stainless steel or standard inlets manufactured after 8-1-93

Part # 6373ELMB



Replacement Interior

- Fits 303SSEL-B, 303SSI-B & 301EL-B boat inlets

Part # 305CRMB



Replacement Interior

- Fits 30A standard non-metallic inlets manufactured prior to 1/1/91

Part # 301CRMB



Replacement Boss Ring

- For use on 30A or 50A stainless steel inlets

Part # 102167 30A

Part # 102164 50A



Warning Labels

- For use on standard inlets
- For warning label placement use per ABYC standard 11.6.2.2.3

Part # 101739

International Shore Power 16A 230V, 50Hz Locking

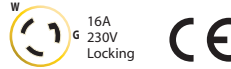

Stainless Steel Inlet

- 316 stainless steel
- Easy Lock™ system
- Soft touch cap design
- Rear safety enclosure with strain relief
- IP56 rated (see inside back cover)

Part # 303SSEL-BXPK
OEM # 303SSEL-BX



Standard Inlet

- Easy Lock™ system
- Glass-filled polyester
- Watertight
- Rear safety enclosure with strain relief
- IP56 rated (see inside back cover)

Part # 301EL-BXPK
OEM # 301EL-BX



Contour Inlet

- Easy Lock™ system
- Glass-filled polyester
- Watertight
- Rear safety enclosure with strain relief
- IP56 rated (see inside back cover)

OEM # 304EL-BX.NT
OEM # 304EL-BX stainless steel trim



Female Connector

- Corrosion resistant contacts and terminals
- Use with cover 103RNX and cap 199109

Part # 305CRCXNPK
OEM # 305CRCXN



Weatherproof Cover w/ Threaded Ring

- Use with 305CRCXN

Part # 103RNXPK
OEM # 103RNX



Connector Kit

- Includes female connector, weatherproof cover with threaded ring and watertight cap

Part # 199114



Locking Shore Power Cordset

- H07BQ-F 3G 2.50 mm² harmonized cable
- IEC 60309 plug 2P+E [6H], 250V/50Hz
- Watertight connector sealing cap for CE compliance
- NEMA L5-30 moulded connector with LED power indicator light

Part # 25MSPPXP 25 meters
Part # 20MSPPXP 20 meters
Part # 15MSPPXP 15 meters
Part # 10MSPPXP 10 meters
Part # 1MSPPXP 1 meters



Harmonized Cable Cordset

- Blunt cut
- H07BQ-F 3G 2.50 mm² harmonized cable
- Watertight connector sealing cap for CE compliance
- NEMA L5-30 moulded connector with LED power indicator light

Part # 20MSPPX 20 meters
Part # 15MSPPX 15 meters



12/3 Cable Cordset

- Blunt cut
- 12/3 (3.3 mm²) cable 16A/220V 50Hz
- Watertight connector sealing cap for CE compliance
- NEMA L5-30 moulded connector with LED power indicator light

Part # 50SPPX 50'
Part # 25SPPX 25'

International Shore Power 32A 230V, 50Hz Locking

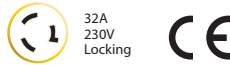

Stainless Steel Inlet

- 316 stainless steel
- Easy Lock™ system
- Soft Touch cap design
- Rear safety enclosure with strain relief
- IP56 rated (see inside back cover)

Part # 6371EL-BX
OEM # 6371ELX no enclosure



Standard Inlet

- Easy Lock™ system
- Glass-filled polyester
- Watertight
- Rear safety enclosure with strain relief
- IP56 rated (see inside back cover)

OEM # 6351EL-BX



Contour Inlet

- Easy Lock™ system
- Glass-filled polyester
- Watertight
- Rear safety enclosure with strain relief
- IP56 rated (see inside back cover)

OEM # 6343EL-BX



Female Connector

- Corrosion resistant contacts and terminals
- Use with cover 7715CRN and sealing cap 199110

Part # 6360CRNXP
OEM # 6360CRNX

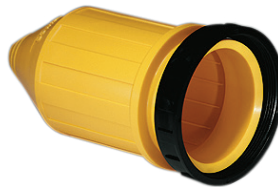

Weatherproof Cover w/ Threaded Ring

- Use with 6360CRNXP, 6401CRCX, 6401CRPX, 6402CRCX, or 6402CRPX

Part # 7715CRNXP
OEM # 7715CRNX



Connector Kit

- Includes female connector, weatherproof cover with treaded ring and watertight cap

Part # 199115



Locking Shore Power Cordset

- H07BQ-F 3G 4 mm² harmonized cable
- IEC 60309 plug 2P+E [6H], 250V/50Hz
- Watertight connector sealing cap for CE compliance
- NEMA SS-1 moulded connector with LED power indicator light

Part # 15M32AXP 15 meters
Part # 1M32AXP 1 meter



Harmonized Cable Cordset

- Blunt cut
- H07BQ-F 3G 4 mm² harmonized cable
- Watertight connector sealing cap for CE compliance
- NEMA SS-1 moulded connector with LED power indicator light

Part # 15M32AX 15 meters



8/3 Cable Cordset

- Male end blunt cut
- 8/3 (8.6 mm²) cable
- Moulded connector with LED power indicator light

Part # 6153SPPX 50'

International Shore Power 63A 230V, 50Hz Locking Single Phase, 3-Wire

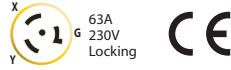

Stainless Steel Inlet

- 316 stainless steel
- Easy Lock™ System
- Soft touch cap design
- Rear safety enclosure with strain relief
- IP56 rated (see inside back cover)

Part # 6401EL-BX



Female Connector

- Corrosion resistant contacts and terminals

Part # 6401CRCX

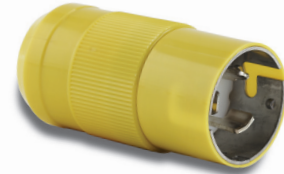

Male Connector

- Corrosion resistant contacts and terminals

Part # 6401CRPX

63A 230V, 50Hz Locking Three Phase, 4 Wire

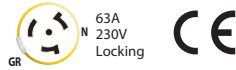

Stainless Steel Inlet

- 316 Stainless steel
- Easy Lock™ system
- Soft touch cap design
- Rear safety enclosure with strain relief
- IP56 rated (see inside back cover)

Part # 6402EL-BX



Female Connector

- Corrosion resistant contacts and terminals

Part # 6402CRCX



Male Connector

- Corrosion resistant contacts and terminals

Part # 6402CRPX



Weatherproof Cover w/ Threaded Ring

- Use with 6360CRNX, 6401CRCX, 6401CRPX, 6402CRCX, or 6402CRPX

Part # 7715CRNXPX

OEM # 7715CRNX

100A 125/250V 3-Pole 4-Wire



Cordsets

All Marinco® cordsets are made of the highest quality, marine grade construction with features you won't find on other power cords.

- For use with 100A 125V/250V shore power systems
- High visibility, 2 AWG, flexible yellow STOW cable is oil, water, UV resistant, and rated to 221°F (105°C)
- Ergonomic non-slip TPE coated gripping surfaces
- IEC pin & sleeve plugs and connectors are designed for harsh environments, watertight, and corrosion resistant. Feature integrated locking rings.
- Internal frame terminals provide high clamping force for safe and secure contact
- Options for use with on-board isolation transformers, male plug only power supply, and extension purposes
- UL and ABYC approved components

Length	Neutral Wire	Female End	Application	Color	Part #
75'	no	yes	Isolation transformer cordset	yellow	CS75IT4
75'	yes	yes	Standard cordset	yellow	CS754
75'	yes	no, blunt cut	Cable winch	yellow	CW754
100'	no	yes	Isolation transformer cordset	yellow	CS100IT4
100'	no	no, blunt cut	Cable winch w/ isolation transformer	yellow	CW100IT4
100'	yes	yes	Standard cordset	yellow	CS1004
100'	yes	no, blunt cut	Cable winch	yellow	CW1004
125'	no	no, blunt cut	Cable winch w/ isolation transformer	yellow	CW125IT4
Extension Cord					
50'	yes	yes	Extension cable	yellow	CS50EXT4*

*CS50EXT4 extension cord has connector body M4100C12 shown below.



Plug w/ Gasketed Locking Ring

- Mate with M4100R12 receptacle

Part # M4100P12



Connector Body

- Mate with plug on extension cords or adapters. Note: It does not mate with shore power inlet.

Part # M4100C12

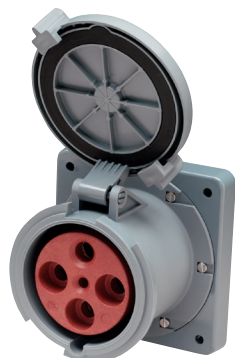

Dock Side Receptacle

- Spring loaded cover providing a IP67 watertight rating when tightened (see inside back cover)

Part # M4100R12



Shore Power Inlet

- Spring loaded cover providing a IP67 watertight rating when tightened (see inside back cover)

Part # M4100B12R

100A 3ØY 120V/208V 4-Pole 5-Wire



Cordsets

All Marinco® cordsets are made of the highest quality, marine grade construction with features you won't find on other power cords.

- For use with 100A 120V/208V shore power systems
- High visibility, 2 AWG, flexible yellow STOW cable is oil, water, UV resistant, and rated to 221°F (105°C)
- Ergonomic non-slip TPE coated gripping surfaces
- IEC pin & sleeve plugs and connectors are designed for harsh environments, watertight, and corrosion resistant. Feature integrated locking rings.
- Internal frame terminals provide high clamping force for safe and secure contact
- Options for use with on-board isolation transformers and male plug only power supply purposes
- UL and ABYC approved components



Length	Neutral Wire	Female End	Application	Color	Part #
75'	No	yes	Isolation transformer cordset	yellow	CS75IT5
100'	No	yes	Isolation transformer cordset	yellow	CS100IT5
100'	No	no, blunt cut	Cable winch w/ isolation transformer	yellow	CW100IT5
125'	No	no, blunt cut	Cable winch w/ isolation transformer	yellow	CW125IT5



Plug w/ Gasketed Locking Ring

- Mate with M5100R9 receptacle

Part # M5100P9



Connector Body

- Mate with plug on extension cords or adapters. Note: It does not mate with shore power inlet.

Part # M5100C9

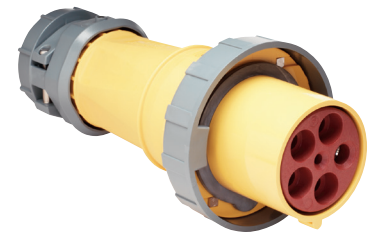

Connector Body w/ Gasketed Locking Ring

- Mate with M5100B9R inlet

Part # M5100C9R

Dock Side Receptacle

- Spring loaded cover providing a IP67 watertight rating when tightened (see inside back cover)

Part # M5100R9



Shore Power Inlet

- Spring loaded cover providing a IP67 watertight rating when tightened (see inside back cover)

Part # M5100B9R



DC POWER CONNECTIONS

12V Receptacles & Plugs



41

Marinco offers a wide selection of high quality DC electrical products that are designed specifically for harsh marine environments.

12V Receptacles & Plug Accessories



42

Mounting brackets, plates, extension cords, and other essential accessories for managing your 12V receptacles and plugs.

12/24V 4.8A Dual USB Receptacles



43

A wide range of USB receptacles for charging mobile device, tablets, and other accessories.

DC POWER CONNECTIONS

Charging / Trolling / Downrigger System



44

Marinco offers a complete line of plugs and receptacles designed exclusively for trolling motors and downriggers. Including the 70A trolling motor plug.

Battery Direct Connect



47

Terminate up to four (4) electronic instruments on each set of battery terminals.



Charging today's mobile devices on the go is a necessity and requires products built to withstand the marine environment.



The importance of a quality DC electrical system

There's an old axiom that states, "The strongest chain is only as reliable as its weakest link," and the same analogy can be applied to your boat's DC electrical system. Put it in a harsh salt water or fresh water environment, where a vessel's wiring and components are subjected to more concentrated abuse in one season than your family car would experience in five years, and it's easy to realize that small electrical problems can get out of hand very quickly.

Safety onboard starts with a reliable DC electrical system that is installed and designed with the proper high quality wiring, components and connections to fulfill all of your intended DC tasks. If you're tempted to take shortcuts when wiring your boat, don't, as these types of cost-cutting measures can come back to bite you at the worst possible moments, potentially compromising the safety of your boat and crew.

So, whether you ply fresh water lakes, back bays, coastal areas or make long distance blue water runs to the edge of the continental shelf, Marincó® offers a wide selection of high quality, low voltage DC electrical products designed specifically for the harsh marine environment.

Now you can spend more time enjoying your boating experience and less time dealing with unwanted electrical hassles.

SeaLink® 12V

The SeaLink® 12V family of products are manufactured from corrosion resistant marine grade materials. Exclusive to SeaLink products is a unique interconnecting system that securely locks the plug into the receptacle resulting in a positive and moisture-proof connection. The plug and receptacle feature optimized metal connection points for maximum conductivity.

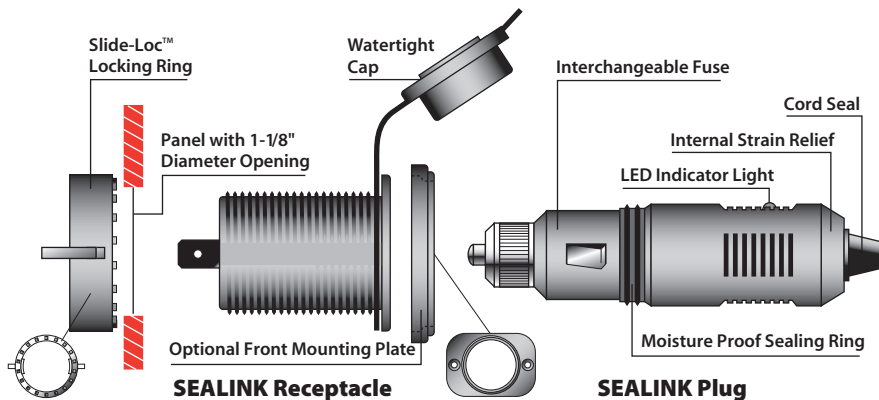

ConnectPro® Charging & Trolling

The ConnectPro® trolling motor plug and receptacle is a revolutionary concept in trolling motor DC connections. The ConnectPro system has superior electric current carrying capacity that eliminates problems that rob motors of power and reduce battery life. The ConnectPro system features a locking plug and receptacle and spring clamping connection, which provides a secure electrical contact.

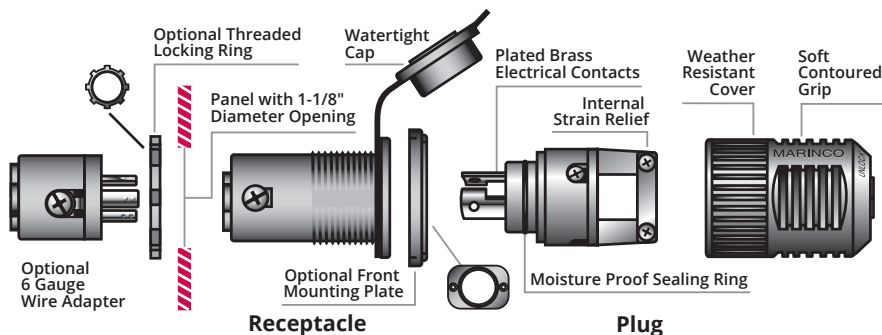

12V Receptacles / Plugs / Accessories



12V Receptacle with Protective Cap

- Stainless Steel
- Includes stainless steel mounting plate and wire set
- Max rating is 15A

Part # 20036



SeaLink® Deluxe 12V Receptacle w/ Old Style Ring

- Watertight sealing cap
- Easy to install with locking ring for rear access installation
- Compatible with standard 12V plugs
- Max rating is 15A

OEM # 12VRCO

OEM # 12VRCY sealed seams



12VRC

SeaLink® Deluxe 12V Receptacle

- Watertight sealing cap
- Easy to install, with supplied mounting plate for front panel installation, or locking ring for rear access installation
- Compatible with standard 12V plugs
- Max rating is 15A

Part # 12VRC black

Part # 12VRC.PG black w/gasket



12VRC.OEM

SeaLink® Deluxe 12V Receptacle

- Watertight sealing cap
- Easy to install with locking ring for rear access installation
- Compatible with standard 12V plugs
- No mounting plate
- Max rating is 15A

OEM # 12VRC.OEM black



SeaLink® Deluxe 12V Plug

- Moisture proof sealing ring
- LED power indicator light
- Interchangeable 10A fuse
- Internal strain relief and cord seal
- Compatible with standard 12V receptacles
- Max rating is 10A

Part # 12VPG

OEM # 12VPG.OEM



SeaLink® Deluxe 12V Receptacle & Plug

- 12VRC and 12VPG packaged together

Part # 12VPG

12V Receptacles / Plugs / Accessories



SeaLink® Mounting Plate

- Easy to install or retrofit
- Use with 12VRCY, 12VRC.OEM, 12VRCO, or 12VBR.OEM

OEM # 12MP.OEM black



SeaLink® Receptacle Mounting Bracket

- Bracket for under dash mounting of the SeaLink® or ConnectPro® receptacles
- Receptacle installs with rear mounting threaded nut
- Marine grade anodized aluminum
- Dimensions: 2" W x 2-1/2" H

Part # 12BKT



Boot

- For use with 12V products
- Creates a weatherproof seal

Part # 300275



Trolling Motor Adapter Terminal

- 6-gauge

Part # 12VPL.OEM



SeaLink® Deluxe 12V Extension Cord

- Heavy-duty 18-gauge wire, extends to over six (6) feet
- Watertight cap
- Plug features an LED indicator light, moisture proof sealing ring, strain relief and built-in 10A fuse
- SeaLink® locking system
- Works with any standard 12V plug and receptacle

Part # 12VXT



USB Chargers



12VDUSB

12VDUSBW-B

SeaLink® Deluxe Dual USB Charger Receptacle

- 12V to 24V DC input
- 5V, 2.1A total output
- LED power indicator light for USB
- Water resistant cover protects against dust and water

Part #	12VDUSB	black (with insulated terminals)
OEM #	12VDUSB-B	black
OEM #	12VDUSBN-B	black no LED
OEM #	12VDUSBW-B	white



12/24V 4.8A Dual USB Charger

- Dual USB ports with 4.8A total output
- Cover prevents dust and water from damaging receptacles

Part # 12VDUSB48



12VCOMBO

12VCOMBOW-B

SeaLink® Deluxe Dual USB Charger & 12V Receptacle

- 12V DC input
- Dual USB has 5V, 2.1A total output
- LED power indicator light for USB
- Receptacle has 12V DC output, rated up to 15A
- Water resistant covers protects against dust and water

Part #	12VCOMBO	black (with insulated terminals)
OEM #	12VCOMBO-B	black
OEM #	12VCOMBON-B	black no LED
OEM #	12VDUSBW-B	white



3-Wire 70A Charging / Trolling System



70A Trolling Motor Receptacle

- 70A continuous rating
- Universal design for 2 or 3-wire configuration 12V, 24V, 12/24V, 24/36V, 36V or 48V systems
- Floating pin design for maximum connectivity and durability
- Corrosion resistant, plated brass electrical components
- Watertight sealing cap
- Accepts 8 and 6 AWG wire

Part # 12VBR53
OEM # 12VBR53.OEM



70A Trolling Motor Plug

- 70A continuous rating
- Universal design for 2 or 3-wire configuration 12V, 24V, 12/24V, 24/36V, 36V or 48V systems
- Floating pin design for maximum connectivity and durability
- Corrosion resistant, plated brass electrical components
- Integrated strain relief
- Keyed design with thumbprint locator
- Accepts 8 and 6 AWG wire

Part # 12VBPS3
OEM # 12VBPS3.OEM



70A Trolling Motor Plug & Receptacle

- 70A continuous rating
- Universal design for 2 or 3-wire configuration 12V, 24V, 12/24V, 24/36V, 36V or 48V systems
- Floating pin design for maximum connectivity and durability
- Corrosion resistant, plated brass electrical components
- Receptacle contains watertight sealing cap
- Plug contains integrated strain relief and keyed design with thumbprint locator
- Accepts 8 and 6 AWG wire

Part # 12VCPS3



TECH TIP

Trolling Motor Amperages

Marinco offers multiple trolling motor plugs and receptacles to accommodate many different trolling motors. To select the correct plug and receptacle for your trolling motor, identify the amperage and voltage rating of your trolling motor. All Marinco trolling motor plugs and receptacles are rated at the stated amperage for continuous use and the amperage rating may vary by voltage. If a trolling motor plug and receptacle is undersized based on the amperage and voltage of the trolling motor, issues may occur.

2-Wire ConnectPro® Charging / Trolling System / Downrigger



ConnectPro® Receptacle

- Works with 12V, 24V, or 36V 2-wire systems
- For front mount panel installations
- Weather resistant sealing cap
- Drain holes in receptacle keep water away from electrical components
- Perma-Lock™ screw terminals will not loosen under extreme hull vibration
- Fits standard 1-1/8" diameter mounting hole
- Accepts 10 and 8 AWG wire

Part # 12VBR52
OEM # 12VBR52.OEM



ConnectPro® Plug

- O-ring seal for waterproof connections
- Weather resistant plug cover
- Corrosion resistant, plated brass electrical components
- Accepts 16 to 8 AWG wire
- Ergonomic contoured grip for easy hook-up and ground blade alignment
- Max rating is 40A

Part # 12VBPS2
OEM # 12VBPS2.OEM



ConnectPro® Receptacle & Plug

- 12VBR52 and 12VBPS2 packaged together

Part # 12VCPS2

3-Wire ConnectPro® Charging / Trolling System



ConnectPro® Receptacle

- Universal design for 2 or 3-wire configuration 12V, 24V, 12/24V, 24/36V or 36V systems
- Watertight sealing cap
- Corrosion resistant, plated brass electrical components
- Drain holes in receptacle keep water away from electrical components
- Perma-Lock™ screw terminals will not loosen under extreme hull vibration
- Standard 1-1/8" diameter mounting hole
- Easy to install, with supplied mounting plate for front panel installation, or locking ring for rear access installation
- Accepts 10 and 8 AWG wire
- Easily replaces other trolling motor plugs and receptacles
- Max rating is 40A

Part # 12VBR with mounting plate
OEM # 12VBR.OEM without mounting plate



ConnectPro® Plug

- O-ring seal for waterproof connections
- Weather resistant plug cover
- Corrosion resistant, plated brass electrical components
- Accepts 16 to 8 AWG wire
- Ergonomic contoured grip for easy hook-up and ground blade alignment
- Max rating is 40A

Part # 12VBP
OEM # 12VBP.OEM



ConnectPro® Receptacle & Plug

- 12VBR and 12VBP packaged together

Part # 12VCP



6 Gauge ConnectPro® Wire Receptacle Adapter

- Allows 6 AWG wire connection to ConnectPro® receptacle
- Corrosion resistant, plated brass electrical components

Part # 12VBRAD
OEM # 12VBRAD.OEM



ConnectPro® Receptacle, Plug & 6 Gauge Adapter

- 12VBR and 12VBP and 12VBRAD packaged together
- Max rating is 40A

Part # 12VCP6

3-Wire 30A 125V Locking Charging / Trolling System



Male Plug

- Short housing, black nylon with internal strain relief system and recessed fasteners

Part # 305BP
OEM # 305BP.OEM



Female Connector

- Short housing, black nylon with internal strain relief system and recessed fasteners

Part # 305BC



Receptacle

- Corrosion resistant reinforced nylon.
- Accepts 8 AWG stranded wire or up to 6 AWG with spade terminals

Part # 305CRRB
OEM # 305CRRB.OEM

4-Wire 12/24V Locking Charging / Trolling System

The 4-wire trolling/charging system eliminates the need for a charge/run switch. Install the receptacle on the boat, mount the black trolling motor plug on the trolling motor, and the red charger plug on the leads of the battery charger. Simply plug in the black plug to troll, or plug in the red plug to charge.

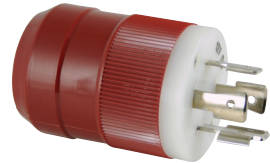

Charger Plug (Male)

- Accepts up to 10 AWG wire
- Red

Part # 2018BP-12



Trolling Motor Plug (Male)

- Connects to trolling motor
- Jumpered internally to supply 12V & 24V power to the trolling motor when plugged into the receptacle
- Accepts up to 8 AWG wire
- Max rating is 60A
- Black

Part # 2018BP-24
OEM # 2018BP-24.OEM



Receptacle & Bracket

- Spring loaded flip lid cover and 2018BR receptacle, pre-assembled

Part # 2018BR-MB



Trolling-Charging System Package

- Includes the 2018BP-12, 2018BP-24, and 2018BR-MB

Part # 2018PKG



Bracket

- Spring loaded flip lid cover, without receptacle

Part # 2018MB
OEM # 2018MB.OEM



Receptacle

- Glass-reinforced corrosion resistant nylon. Accepts 8 AWG stranded wire or up to 6 AWG with spade terminals.

Part # 2018BR
OEM # 2018BR.OEM
OEM # 2018BR.OEM.BPS (case pack)

Battery Direct Connect™ Multi Connection Battery Terminals

- Terminate up to four electronic instruments on each set of terminals
- Comes complete with quick-connect terminals
- Positive molded in red, negative molded in black
- All one-piece, no screws or parts to lose
- Cover snaps tight when closed
- Meets ABYC standard E-10.8

Part # 12VTR
 OEM # 12VTR.OEM

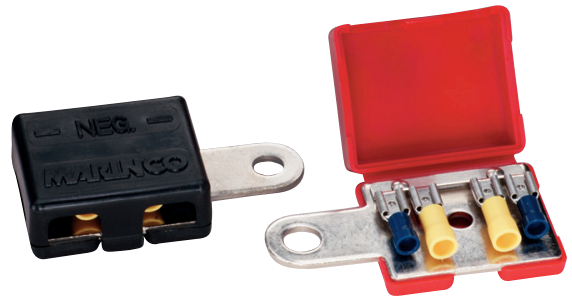

TECH TIP

Battery Direct Connect™ Details

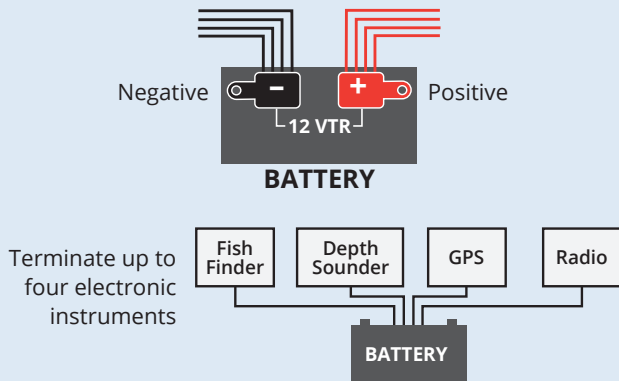

POWER CONVERSION

Guest ChargePro™ On-Board Battery Chargers



50

New line of Guest chargers ranging from 5A to 40A, with fully automatic 5-stage performance charging for 12V lead acid and AGM batteries. Chargers have dedicated outputs, aluminum housings and expanded LED charge status. 100% waterproof and shock resistant for all fresh and salt water applications.

1.5 Amp ChargePro™ Maintainer



52

Keep your battery charged with this highly reliable, Guest 1.5 Amp maintainer. Extends battery life and will charge, monitor and re-charge your battery if the voltage drops below 12.9V. The maintainer can be safely connected to the battery for short or long periods of time.

POWER CONVERSION

Guest Portable Battery Chargers



53

Take the charger to the battery with the Guest portable charger. Charges and maintains a full charge without the fear of overcharging or boiling electrolytes.

Battery Charger Accessories



56

Intuitive new charger accessories simplify installation and operation.



CHARGEPRO™

Guest On-Board Battery Chargers

For 12V, 24V, 36V and 48V systems (model specific)

Guest On-Board battery chargers have been redesigned from the inside out with the customer in mind. Our newest generation On-Board Marine battery chargers include leading advancements in digital charging technology and waterproof design/construction. Designed to maximize individual battery performance, extend battery life and show battery status better than ever before.

Every Guest charger has a dedicated output that delivers the full amount of amps per bank. The easy to read graphics indicates the status of each battery bank through the charging process.

ChargePro's low profile flangeless extruded aluminum housing is sealed by gaskets with heavy duty end caps for 100% waterproof performance to IP67. This new construction design delivers an increase in charging and thermal management performance. The new ChargePro Series is up to 40% lighter while increasing durability and ease of installation over prior generations of older technology epoxy filled plastic body chargers.

- All high frequency, digital charging technology
- Microprocessor and software control for precision, fully automatic 5-stage performance charging
- Dedicated battery charging, sensing and control per bank
- Expanded LED charge status monitor
- Wiring and battery fault detection
- Auto-maintain energy saver mode
- Up to 40% lighter
- 100% Waterproof (IP67) and shock resistant for all fresh and saltwater applications (see inside back cover)
- All models are pre-wired for easy installation
- For all 12V flooded and AGM lead acid batteries
- Built-in safety: reverse polarity, over-current, over-voltage, over-temperature and ignition protection. In-line fuses for maximum DC wire protection.
- 2-year warranty



2713A



2711A



2708A



Expanded LED display

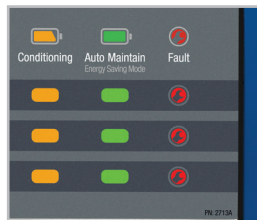

Battery fault detection LEDs



Heavy-Duty strain reliefs

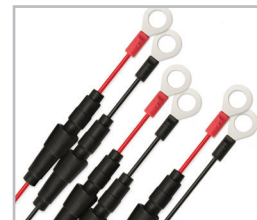

In-line safety fuses

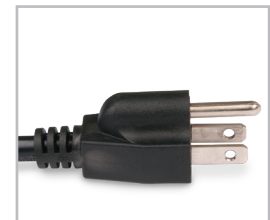

NEMA 5-15P plug



Certified to:
UL STD 1236
CSA C22.2 No. 107.2
FCC Class B

IP67
See inside
back cover



Designed and
Constructed to: **ABYC**
ABYC-31 *Setting Standards for Safer Boating*

Guest ChargePro™ Series Selection

ChargePro 5A to 20A Models



Model	ChargePro 5	ChargePro 4/4	ChargePro 10	ChargePro 5/5	ChargePro 5/5/5	ChargePro 10/10
Part #	2708A	2707A	2710A	2711A	2713A	2720A
Input Volts	90-135V AC 50/60Hz	90-135V AC 50/60Hz	90-135V AC 50/60Hz	90-135V AC 50/60Hz	90-135V AC 50/60Hz	90-135V AC 50/60Hz
DC System Voltage	12	12/24	12	12/24	12/24/36	12/24
Banks	1	2	1	2	3	2
Amps	5	4/4	10	5/5	5/5/5	10/10
Amps Per Bank	5	4	10	5	5	10
AC Cord Length	6'	6'	6'	6'	6'	6'
Size (W x H x L)	7.5" x 2.4" x 7.2" 191 x 61 x 183 mm	7.5" x 2.4" x 9.0" 191 x 61 x 229 mm	7.5" x 2.4" x 9.0" 191 x 61 x 229 mm	7.5" x 2.4" x 9.0" 191 x 61 x 229 mm	7.5" x 2.4" x 12.9" 191 x 61 x 328 mm	7.5" x 2.4" x 12.9" 191 x 61 x 328 mm
Weight (lbs)	3.2	4.5	4.2	4.7	6.7	6.6

ChargePro 30A and 40A Models

Designed for demanding 12V, 24V, 36V and 48V battery systems requiring 10per battery for the fastest charge times.



Model	ChargePro 10/10/10	ChargePro 10/10/10/10
Part #	2731A	2740A
Input Volts	90-135V AC 50/60Hz	90-135V AC 50/60Hz
DC System Voltage	12/24/36	12/24/36/48
Banks	3	4
Amps	10/10/10	10/10/10/10
Amps Per Bank	10	10
AC Cord Length	6'	6'
Size (W x H x L)	9.0" x 4.1" x 8.7" 229 x 104 x 221 mm	9.0" x 4.1" x 8.7" 229 x 104 x 221 mm
Weight (lbs)	8.0	8.5

Fully Automatic Multi-Stage Performance Charging Overview

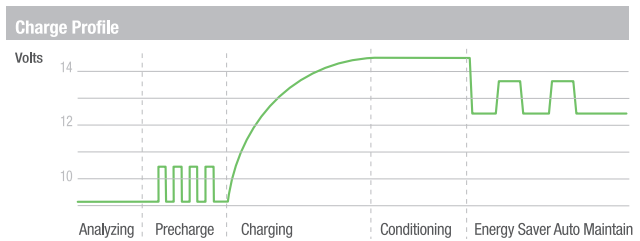

Chargepro's 5-Stage Performance Charging Algorithm is Fully Automatic and Designed to Maximize Battery Performance and Extend Battery Life.

Stage 1 - Analyze Mode: AC power is applied. ChargePro's red charging LED will flash indicating it is analyzing individual wiring connections for proper connection/polarity and that each battery is over 4.0V DC and capable of accepting a precharge. When completed, any errors will trip a battery specific red fault LED, or if no faults are present the red charging LED will illuminate solid red.

Stage 2 - Precharge Mode: For batteries under 10V, this mode is designed to pulse the battery up to 10V before accepting full rated constant current (Stage 3). During this mode the red charging LED will be illuminated with a solid on.

Stage 3 - Charging Mode Constant Current: During this mode the red charging LED will be illuminated with a solid on indicating each battery is being charged in constant current mode as controlled by temperature until the battery voltage is raised to a precise 14.6V DC and the red charging LED will shut off.

Stage 4 - Conditioning Mode Constant Voltage: During this mode the amber conditioning LED will be solid on indicating each battery is being conditioned at 14.6V for up to 3 hours until the battery is fully charged. Followed by the amber LED turning off while the charger enters into Stage 5.

Stage 5 - Storage Recondition Mode: During this mode the blue AC power and green auto maintain LED will be solid on indicating each battery is being monitored while the charger is in standby mode consuming little to no power until the battery drops under 12.8V (fully charged) and the charger will turn on and auto maintain the battery in a fully charged state. This is fully automatic and safe for short and long term storage.

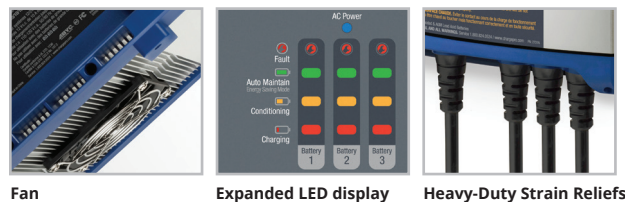

Fan

Expanded LED display

Heavy-Duty Strain Reliefs

Related Products



AC Plug Holder
page 54



Cable Extender
page 55

1.5 Amp ChargePro™ Maintainer

Keep your battery charged with this highly reliable, Guest 1.5 Amp maintainer. Extends battery life and will charge, monitor and re-charge your battery if the voltage drops below 12.9V. The maintainer can be safely connected to the battery for short or long periods of time. To increase versatility the maintainer comes with alligator clips and ring terminals for the output cable. This maintainer will charge smaller batteries and maintain batteries up to 150Ah (group 31).

- Ideal for sport fishing boats, ski boats, jet ski's, ATV's, automobiles, tractors, riding lawn mowers and more
- For Flooded, Gel and AGM batteries
- Charge batteries 1.2 Ah to 40 Ah
- Maintain batteries 1.2 Ah to 150 Ah
- Energy savings mode automatically shuts off the charger when the battery is charged. The charger periodically monitors the battery and turns back on when the battery falls below 12.9V.
- Maintainer can safely stay connected to the battery for long periods of time
- LEDs let you know when the Power is ON, battery is being charged and when charging is complete.
- Includes ring terminals and alligator clips for connection to the battery
- Weather resistant, IP65 (see inside back cover)
- 3-wire AC plug, NEMA 5-15P
- 3-year warranty
- Meets UL 1236 and CSA Standards, cETLus



Concealed Mounting

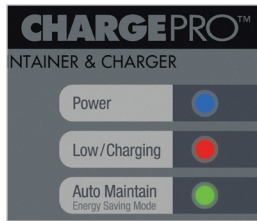

Expanded LED Status Center



Portable Foam Resting Pad



Included DC Cable Assemblies



NEMA 5-15P Plug

Part #	Output Volts	Output Amps	Banks	Cable Length	Size (WxHxD)	Weight	AC In
2701A	12V DC	1.5 A	1	6'	5.0"x5.8"x2.0" 127 x 147 x 51 mm	2.3 lbs	120V AC 60Hz



Conforms to:
Marine UL 1236 SB
CSA C22.2 No. 107.2
FCC Class A

Designed and
Constructed to:
ABYC A-31
Setting Standards for Safer Boating

Portable Battery Chargers



Model	6 Amp Battery Charger	3 Amp Battery Charger
Part #	2606A-B	2603-B
Total amps	6A	3A
Outputs	1	1
Amps per out	6	3
Battery System	12V	12V
Input Voltage	100-130V AC / 60Hz	100-130V AC/60Hz
Output Voltage	12V	12V
AC	6' AC cord with standard plug	18" AC cord with standard plug
Dimensions	5.5" x 5.0" x 2.4" 140 x 127 x 61 mm	3.10" x 3.50" x 2.34" 79 x 89 x 59 mm
Weight	3.5 lbs / 1.6 kg	1.0 lbs / 0.5 kg



Universal AC Plug Holder+

Universal design for all standard 120V AC plugs

- Plug clamp insert included—converts plug holder to an AC inlet for Guest engineered chargers
- No cutting, stripping or rewiring of AC power cord
- Watertight and UV resistant cover
- Easy to reach safe AC power cord connections
- Stainless steel mounting screws included
- Easy installation
- Compatible with Guest ConnectCharge™ plug

Description	Part #
Black	150PHB
White	150PHW



Plug Clamp Insert

Available in black or white

AC Plug Holder Configurations—Multi-Use Design

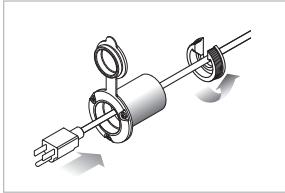

Universal Plug Holder
Fits marine chargers with 120V plugs.

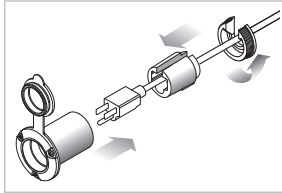

With Plug Clamp Insert
For all ProMariner chargers, Bass Pro shops, Cabela's and Guest chargers.

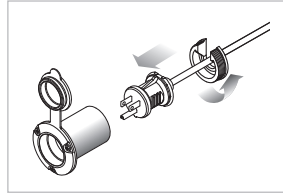

ConnectCharge™ Plug
Guest and MarInco ConnectCharge plug



Hard Wired Charger Inlets

- 15A or 20A 125V straight blade inlet
- Low profile cap won't catch fishing line
- Mounts easily to fiberglass and aluminum hulls
- Perma-Lock™ terminals and color coded wire entrance holes make wiring a snap
- UV resistant housing/cap

Amp	Color	Universal Mount Part #	Front Mount OEM #	Rear Mount OEM #
15	Black	150BBI	150BBI.OEM	150BBI-TM
15	White	150BBIW	150BBIW.OEM	—
20	White	—	200BBIW.OEM	—



15A 125V
Straight Blade



20A 125V
Straight Blade

Charger DC Cable Extenders

Universal design for all marine chargers with ring terminal cables

- Rated up to 30A
- Color coded for quick and easy installation
- No cutting, stripping or splicing required
- Slide & snap fully insulated connection covers
- Corrosion resistant tinned 12 AWG copper wire and gold plated hardware
- Dual inline waterproof fuses for maximum wire protection
- Available in 5 ft or 15 ft cable lengths
- Use with all on-board marine battery chargers when standard battery charger cables do not reach your bow, center mount or stern battery compartment locations

Description	Part #
5 ft	27505
15 ft	27515



Easy to extend charger cables with two 1/2" wrenches

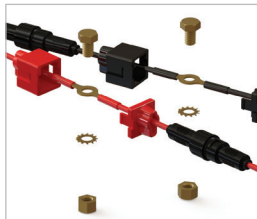

Step 1:
Align charger red and black wires and assemble hardware as shown

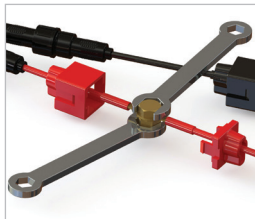

Step 2:
Tighten all hardware to approximately 12 ft. lbs.

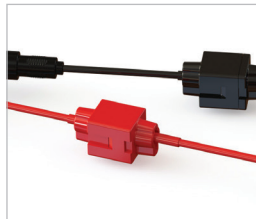

Step 3:
Slide and snap connection cover

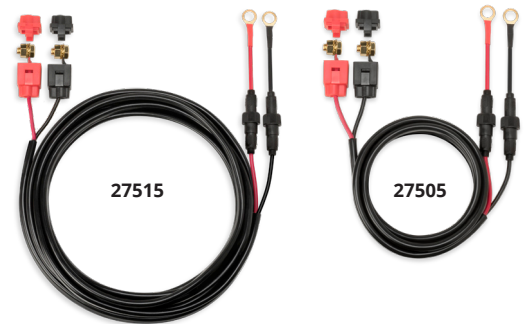

BATTERY MANAGEMENT

Dynaplates



58

Improve the performance of electronics and reduce RF interference. Deters electrolysis and galvanic corrosion.

Universal Mount Switches



59

Longer stud length for easier assembly and cable routing.



BATTERY MANAGEMENT

Battery Selector Switches



Durable polycarbonate case. Available with or without alternator field disconnect. For 6V, 12V, 24V, or 36V systems.

Heavy-duty Diesel Power Battery Switches



Constructed with heavy-duty copper sweep contacts to ensure positive circuit control. Features alternator field disconnect to protect the electrical system during switching.

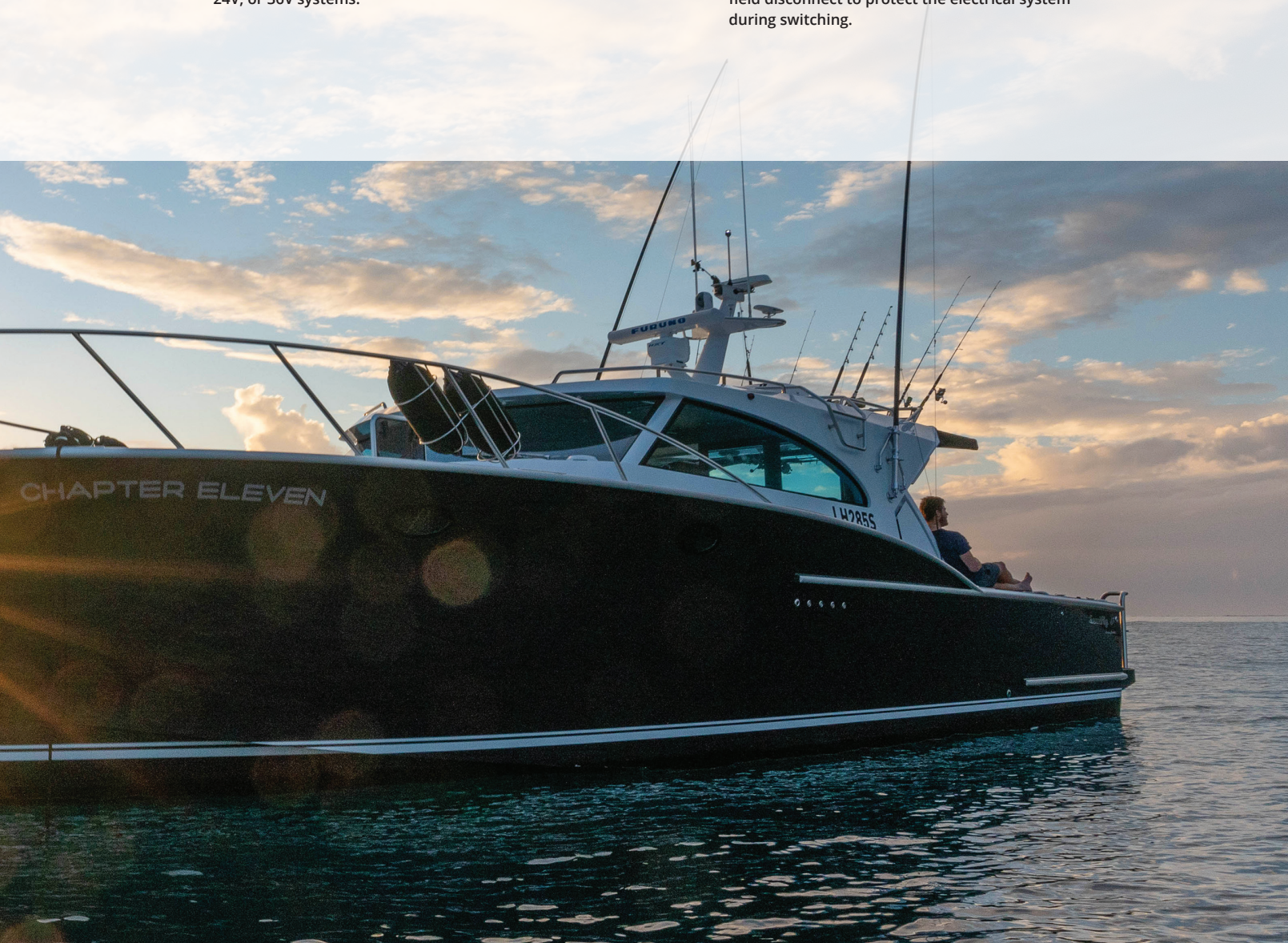

Battery management systems protect and support rechargeable batteries by extending the charge and life cycle of your batteries.

Dynaplates for Hull Bonding & Grounding

- Improves performance of electronics and reduces RF interference
- Offers the best path for hull bonding without long runs of copper foil
- Deters electrolysis and galvanic corrosion
- Sintered porous bronze sphere construction for maximum conductivity in a compact size
- Low drag, non-fouling shape
- Easy to clean with wire brush
- Conforms to ABYC standards
- Mounting hardware included
- Gold plated mounting bolt
- Bronze mounting nuts



	Standard 4006	Large 4008	Giant 4012	Super 4018
Part #	4006	4008	4012	4018
Use for	bonding and grounding	bonding, grounding and Loran use	bonding, grounding and Loran use	SSB radio
Dimensions	6" x 2" x .5" 152 x 51 x 13 mm	8" x 2.5" x .5" 203 x 64 x 13 mm	12" x 3" x .5" 305 x 76 x 13 mm	18" x 6" x .5" 457 x 152 x 13 mm
Mounting holes	2-1/2" center to center	4" center to center	6" center to center	9.875" center to center; 3" top to bottom
Weight	1.4 lbs / .6 kg	2.1 lbs / 1 kg	3.7 lbs / 1.7 kg	11.1 lbs / 5 kg

Accessories for dynaplates

Part	Material	Use with:	Dimensions	Part #
Washer	Bronze	4006/4008	1/4" x 20"	P-11D03
		4012/4018	3/8" x 16"	P-11D04
Bolt	Bronze	4006/4008	1/4" x 20"	P-12D34
		4012/4018	3/8" x 16"	P-12D36
	Bronze Gold Plate	4006/4008	1/4" x 20"	P-12D35
		4012/4018	3/8" x 16"	P-12D37

Part	Material	Use with:	Dimensions	Part #
Nut	Bronze	4006/4008	1/4" x 20"	P-13A27
		4012/4018	3/8" x 16"	P-13A29
	Bronze Gold Plate	4006/4008	1/4" x 20"	P-13A28
4012/4018		3/8" x 16"	P-13A2A	

TECH TIP

Choosing a Battery Switch

ABYC requires a battery switch on every boat with a battery over 800 Cold Cranking amps (CCA). This requirement exists so the potentially destructive energy in the batteries can be isolated in the event of a fire.

Universal Mount Switches

- Longer stud lengths for improved assembly and easier cable routing
- Built with heavy-duty copper sweep contacts to ensure positive circuit control
- Rugged internal components protected by a tough, impact resistant polycarbonate housing that is impervious to the elements
- Cable Lug Size: 3/8"
- Dimensions: 5.0" x 2.75"



Selector Switch w/out AFD

Continuous: 230A
Momentary: 345A



Description	Part #	OEM #
black	2111A	2111A-B
orange	2111A-O	—
red	2111A-17	—

Selector Switch with AFD

Continuous: 230A
Momentary: 345A



Description	Part #	OEM #
black	2110A	2110A-B

On/Off Switch w/out AFD

Continuous: 230A
Momentary: 345A



Description	Part #	OEM #
black	2112A	2112A-B

Battery Selector Switches

- Polycarbonate case
- For 6V, 12V, 24V or 36V systems
- Surface mount
- Cable Lug Size: 3/8"
- Dimensions: 5.50" x 2.63"



Selector Switch with AFD

Continuous: 230A
Momentary: 345A



Description	Part #	OEM #
orange	2100	2100-B

Selector Switch w/out AFD

Continuous: 230A
Momentary: 345A



Description	Part #	OEM #
orange	2101	2101-B

On/Off Switch w/out AFD

Continuous: 230A
Momentary: 345A



Description	Part #	OEM #
orange	2102	2102-B

Heavy-duty Diesel Power Battery Switches

- For 6V, 12V, 24V or 36V systems
- Built with heavy-duty copper sweep contacts to ensure positive circuit control
- Rugged internal components protected by a tough, impact resistant polycarbonate housing that is impervious to the elements
- All feature Alternator Field Disconnect (AFD) allowing selection of any position, including "off", without damage to alternator or electrical system
- Cable lug size: 1/2"
- 2304A and 2304A-B have 3 studs



Heavy-duty On/Off Switch

Continuous: 450A
Momentary: 800A



Description	Part #	OEM #
gray	2303A	2303A-B

Extra-duty On/Off Switch

Continuous: 600A
Momentary: 1000A



Description	Part #	OEM #
gray	2304A	2304A-B

Battery Selector Switch

Continuous: 360A
Momentary: 600A



Description	Part #	OEM #
gray	2300A	2300A-B

Battery Switch Operation Diagrams

As more and more electronics and electrical accessories are added to your boat (autopilot, refrigeration, etc.) the use of multi-batteries becomes a necessity. Guest components allow you to set up the system (from simple to complex) for your boat's application. The following diagrams are for use in identifying and designing the right system for your boating needs.

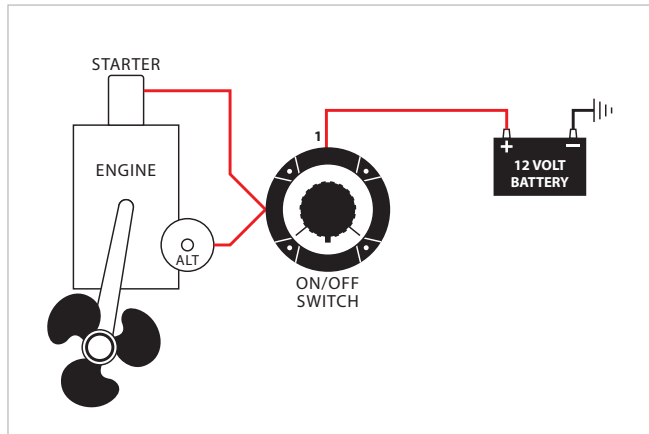

Single battery

Installation: To shut off all power at source. Recommended installation by approved authorities.

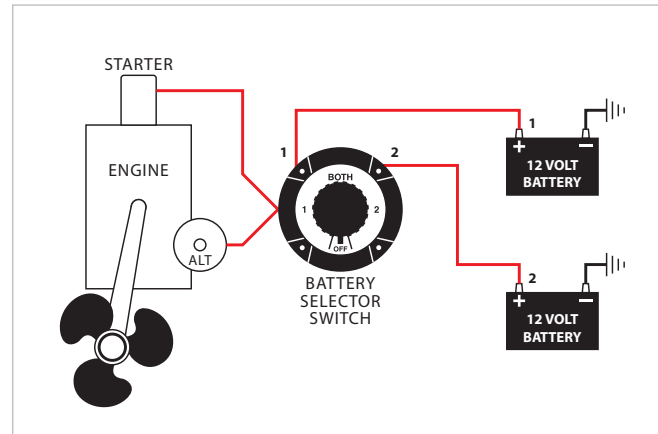

Two batteries without isolator

Installation: To select a starter battery and ship service battery. Manually isolates each battery, parallels both batteries for emergency start, master disconnect, manually selects batteries for charging.

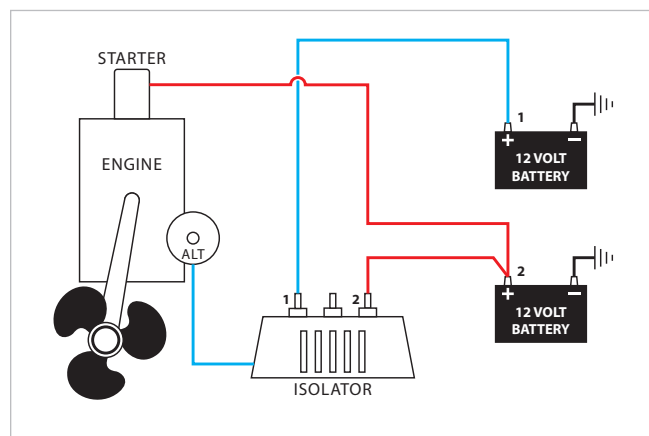

Two batteries with isolator

Installation: Isolator automatically selects lower charged battery to be charged first. Full battery can't discharge to drained battery. Dedicated system, no flexibility, no emergency parallel or disconnect function.

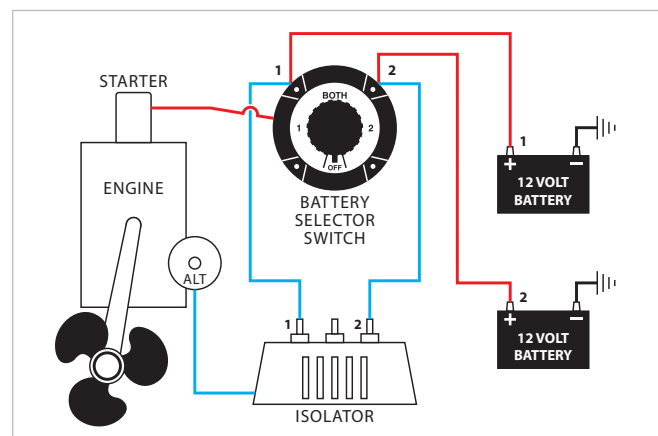

Two batteries with emergency parallel

Installation: An isolator automatically isolates each battery, lower charged battery will automatically be charged first. Two different size batteries can be used, larger for ship services, smaller for engine cranking. Switch selects usage, master disconnect, emergency parallel function.

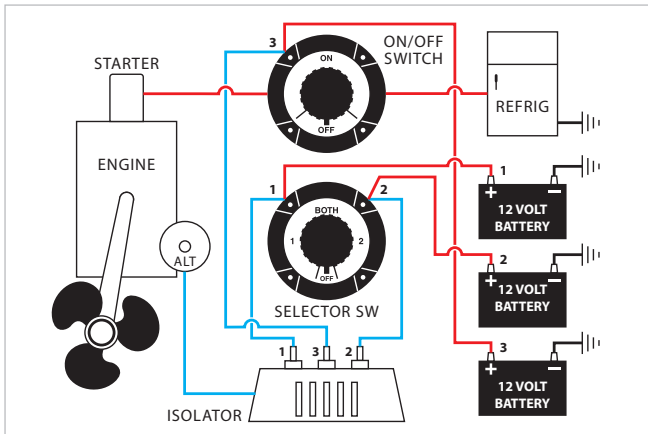

One battery selector switch, one On/Off selector switch automatic battery isolation and automatically charges three batteries

Installation: Use for sailboats and trawlers. Third battery isolated from other ship circuits. All batteries being automatically charged while running through isolator. To be used for refrigeration or other heavy load devices. Isolator protects other batteries.

Switch selector usage:

- 1. Master disconnect
- 2. Emergency parallel function

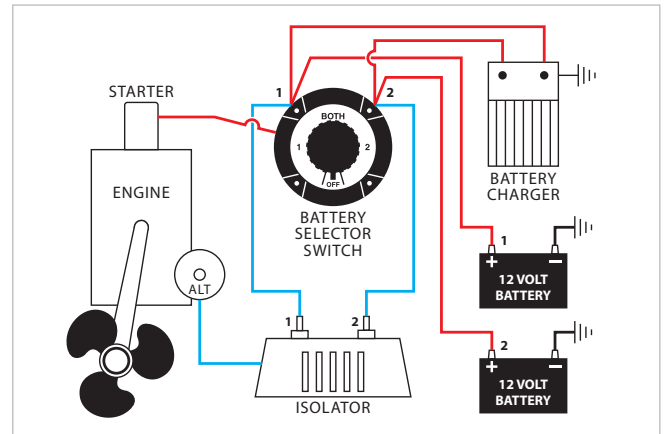

Adding automatic battery charger/converters to system

Installation: At dock side multi-bank charger built in isolator which will automatically charge lower battery.

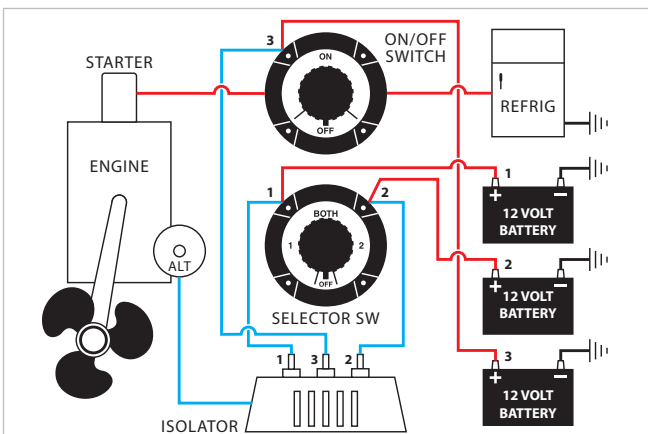

Three batteries, one battery selector switch, one On/Off or selector switch, two alternators, one isolator

Installation: Isolator separates both alternators so both alternators will charge simultaneously. Automatically charges lowest battery first. All batteries can be used for start, third battery, ship's source.

Alternator Field Disconnect (AFD)

Allows selection of any position, including "Off," without damage to alternator or electrical system. AFD is required on some electrical systems.

- Heavy-duty copper sweep contacts
- Positive click-stop on all positions
- "Make before break" contacts allow selection of all positions except "Off" while engine is running
- New design is easy to retrofit into existing hole patterns
- Use with 6V, 12V, 24V or 36V systems
- Built-in skirt protects connections
- Surface or rear panel mounting
- Marine grade construction

Important Note: The boater's electrical needs and problems should be discussed with your boatyard's electrical technician.



Exclusive flat 360 "sweep" contact design provides up to 60% more contact area than other switch designs.

WIPER SYSTEMS

Wiper Motors & Kits



64

Marinco® motors are split into three categories, Standard, Heavy-Duty, and Heavy-Duty Plus, with the categories being defined by the power range of the motors. Within the three categories, there are motors designed for interior or protected installations, and motors designed for exterior installations. We offer wiper motors for all windshield sizes up to 45", which could be covered by a 30" arm and 30" blade combination, driven by a 3.0 motor.

Wiper Arms



72

Wiper arms are available in Standard, Deluxe, and Premier styles and the primary construction material in all wiper arms is stainless steel. Deluxe arms are used on Standard and Heavy-Duty motors. The arms are available in a wide range of sizes, in both black and stainless steel finish, and regular and pantographic models. Pantographic arms use a set of two arms joined together to give a flatter and somewhat wider sweep pattern.



WIPER SYSTEMS

Wiper Blades



75

Standard, Deluxe and Premier Plus wiper blades are offered in different sizes and styles to fit all of the different types of wiper arms. Premier and Deluxe styles have stainless steel frame construction and high-end silicone rubber squeegees. For maximum performance of all blade styles, replacement of wiper blades is recommended every six (6) months.

Windshield Washer Kits



77

A full line of easy-to-install windshield washer kits are available.



Wiper assembly systems ensure your visibility remains clear through a storm or vicious passages.

Wiper Motors

The motor choice is based primarily on the size of the windshield and where the motor is to be installed, either in an exterior or interior location. Marinco motors are split into two categories, Standard and Heavy-Duty with the categories being defined by the power range of the motors. Within the two categories, there are motors designed for interior or protected installations, and motors designed for exterior installations.

The Standard motor category includes the STD, WMW, and 500, which are all designed for light duty use, defined as being able to drive a 14" arm and a 14" blade.

When coverage of a larger windshield is required, Marinco® offers the Heavy-Duty motors, which are capable of driving a

wide range of arm and blade sizes, up to a 26" x 26" Deluxe arm and blade combination, which would cover windshields up to 39". The 1000 motor can pull up to a 16" x 16" Deluxe arm and blade combination. The MRV is built for interior or well-protected locations, and has the power to pull a 22" X 22" Deluxe arm and blade combination. The 1.5 motor has the power to pull a 22" x 22" Deluxe arm and blade combination like the MRV, but is waterproof and built for exposed installations. The 2.5 motor has the power to pull a 26" x 26" Deluxe arm and blade combination and is waterproof for exposed installations.

Choosing the Right Motor

	Model	Voltage	Speeds	Stall Torque/ Stall Current	Compatible Blade Lengths	Available Shaft Lengths	Sweep Angles	Housing
	2.5	12V & 24V	2 speed	139 in-lbs / 9A-10.5A	26" Deluxe 24" Premier	2.5"	Factory preset: 80° or 110° Adjustable: 45° or 60°	Fully sealed powder coated aluminum
	1.5	12V & 24V	2 speed	109 in-lbs / 11.5A-13A	22" Deluxe 20" Premier	1.5" 2.5"	Factory preset: 80° or 110° Adjustable: 45° or 60°	Fully sealed powder coated aluminum
	3000	12V	2 speed	159 in-lbs / 10.2A-12.2A	26" Deluxe 26" Premier	1.5" 2.5"	Factory preset: 80° or 110° Adjustable to 40°, 50°, 60°, 70°, 80°, 90°, 100° or 110°	Fully sealed aluminum
	1000	12V	Single	55 in-lbs / 9.8A-10A	16" Deluxe 18" Premier	1.5" 2.5"	Factory preset: 65°, 80° or 110° Adjustable: 50°, 65°, 80° or 110°	Fully sealed, UV stabilized hi-temp thermoplastic
	MRV	12V & 24V	2 speed (but can be operated as 1)	109 in-lbs / 11.5A-13A	22" Deluxe 20" Premier (at 80° sweep)	1.5" 2.5" 3.5"	Factory preset: 80° or 110° Adjustable: 45°, 60°, 80° or 110°	Corrosion resistant cast housing
	500	12V	Single	—	14" Deluxe	2.5"	Factory preset: 80° or 110°	Fully sealed, UV stabilized hi-temp thermoplastic
	WMW	12V	Single	—	14" Deluxe	2.5"	Factory preset: 110°	Chrome plated brass case
	STD	12V	Single	—	14" Deluxe	2.5" 3.5"	Factory preset: 80° or 110° Adjustable: 80° or 110°	Corrosion proof aluminum alloy case

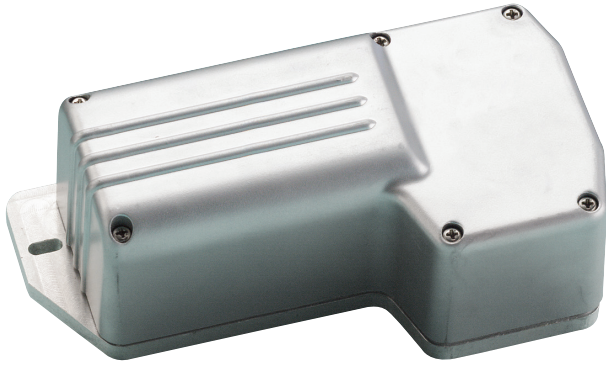

3 YEAR WARRANTY
CE

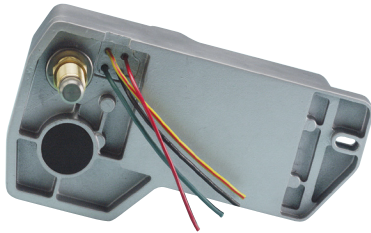

2.5 Waterproof Wiper Motor

- Fully sealed powder coated aluminum waterproof base and housing
- Powers a 26" Deluxe arm and Deluxe blade combination or a 24" Premier arm and Deluxe blade combination
- Available in two (2) shaft lengths: 1.5" and 2.5" (includes .5" length of knurled arm fitting)
- Factory pre-set sweep angles of 80° or 110°, with easy adjustment to 45° or 60°
- Chrome plated solid brass knurled drive nut with brass and stainless steel drive shaft
- Two-speed motor
- Sealed 6" wire leads, 16 AWG
- Adjustable right or left self parking
- .625" diameter shaft (16 mm)
- Available in 12V and 24V models
- Coast to park
- RF shielded circuitry
- Retail version includes 6A fuse and holder (operating switch not included)
- Measures approximately 7.875" L x 4.25" W x 3" D (see below for detailed dimensional drawings)
- Stall torque: 139 in-lbs (160 kgf/cm; 15.7 Nm)
- Stall current: 9.0A-10.5A
- No load current: 1.0A -1.6A

Related Products



Intermittent Wiper Motor Controller
page 70

Description	Voltage	Sweep	Part #	OEM #
2.5" Shaft	12V	80°	82082	82182
		110°	82012	—
	24V	110°	82312	—

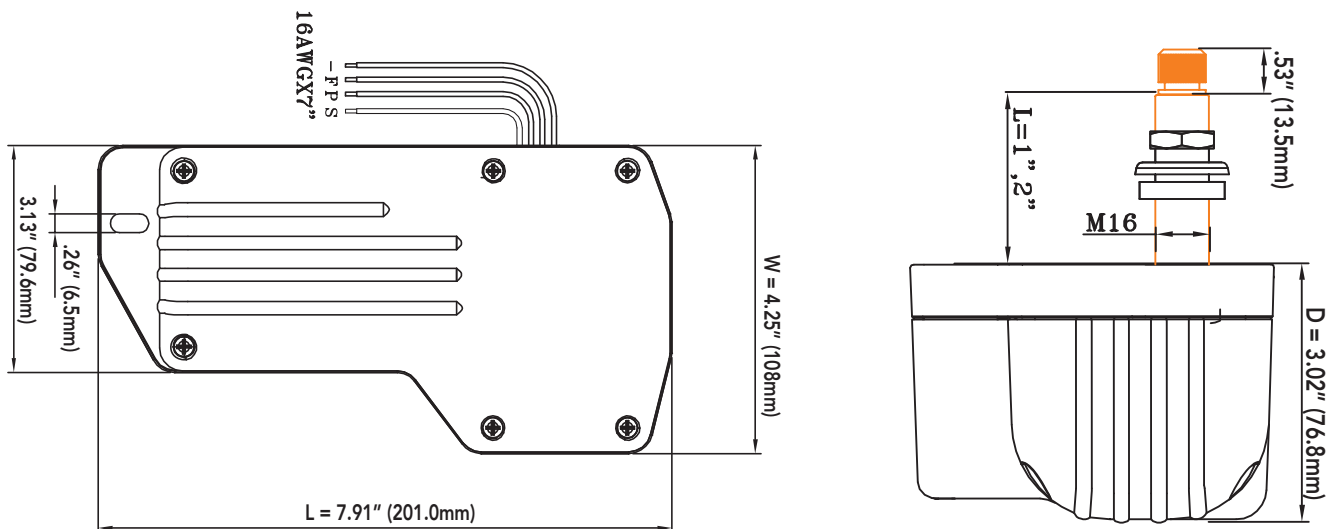

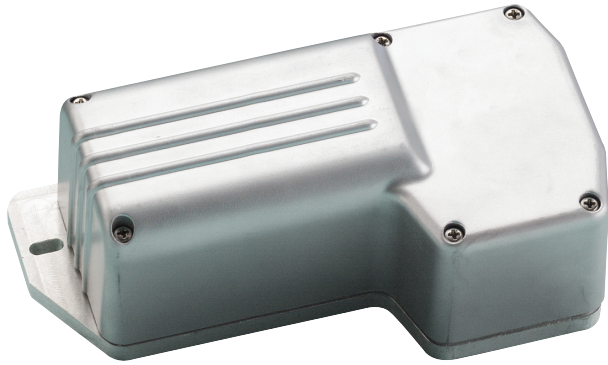

3 YEAR WARRANTY
CE

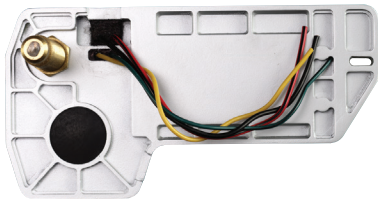

1.5 Waterproof Wiper Motor

- Fully sealed powder coated aluminum waterproof base and housing
- Powers a 22" Deluxe arm and 22" Deluxe blade combination or a 20" Premier arm and 20" Deluxe blade combination
- Available in three (3) shaft lengths: 1.5" and 2.5" (includes .5" length of knurled arm fitting)
- Factory pre-set sweep angles of 80° or 110°, with easy adjustment to 45° or 60°
- Chrome plated solid brass knurled drive nut with brass and stainless steel drive shaft
- Two-speed motor
- Sealed 6" wire leads, 16 AWG
- Adjustable right or left self parking
- .625" diameter shaft (16 mm)
- Available in 12V
- Coast to park
- RF shielded circuitry
- Retail version includes 5A fuse and holder (operating switch not included)
- Measures approximately 7.75" L x 4" W x 2.75" D (see below for detailed dimensional drawings)
- Stall torque: 109 in-lbs (125 kgf/cm; 12.3 Nm)
- Stall current: 11.5A-13.0A
- No load current: 0.5A-1.2A
- *Replaces AFI 2000 motor*

Related Products



Intermittent Wiper Motor Controller
 page 70

Description	Voltage	Sweep	Part #	OEM #
1.5" Shaft	12V	80°	71081	—
		110°	71011	—
2.5" Shaft	12V	80°	71082	71182
		110°	71012	71112

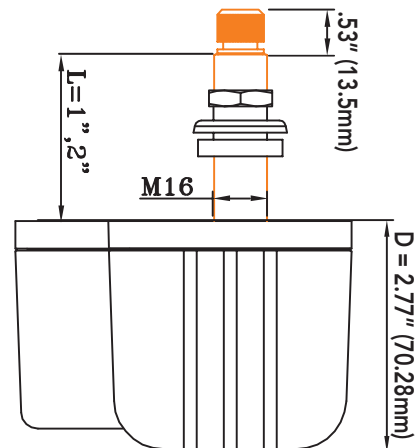
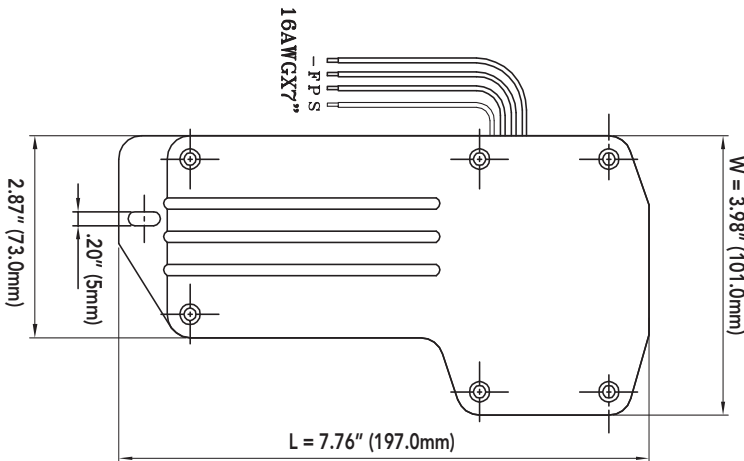

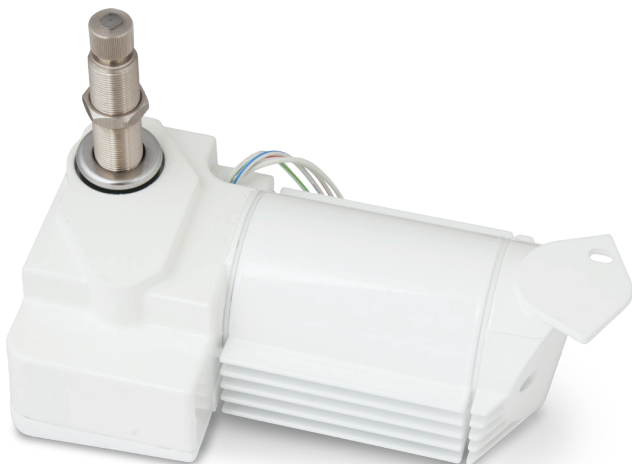

3 YEAR WARRANTY



3000 Waterproof Wiper Motor

- Fully sealed powder coated aluminum waterproof base and housing
- Powers a 26" Deluxe arm and Deluxe blade combination or a 24" Premier arm and Deluxe blade combination
- Available in two (2) shaft lengths: 1.5" and 2.5" (includes .5" length of knurled arm fitting)
- .625" diameter shaft (16 mm)
- Factory preset sweep angles of 80° or 110°, with easy adjustment from 40° to 110° at 10° increments
- Sealed 6" wire leads, 16 AWG
- Adjustable right or left self parking
- Two-speed settings
- Retail version includes 5A fuse and holder (on/off switch not included)
- Isolated ground
- Stall torque: 159 in-lbs (183 kgf/cm; 18 Nm)
- Stall current: 10.2A-12.20A
- IP66 rated (see inside back cover)

Description	Voltage	Sweep	Part #	OEM #
1.5" Shaft	12V	80°	83081	83181
		110°	83011	83111
2.5" Shaft	12V	80°	83082	83182
		110°	83012	83112

Related Products



Intermittent Wiper Motor Controller
page 70

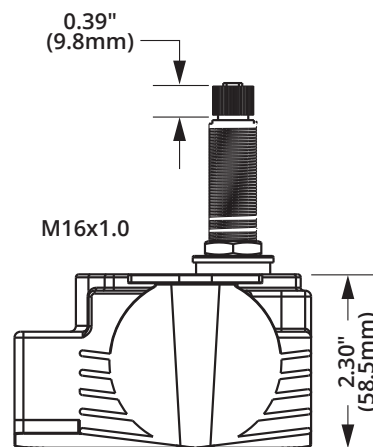
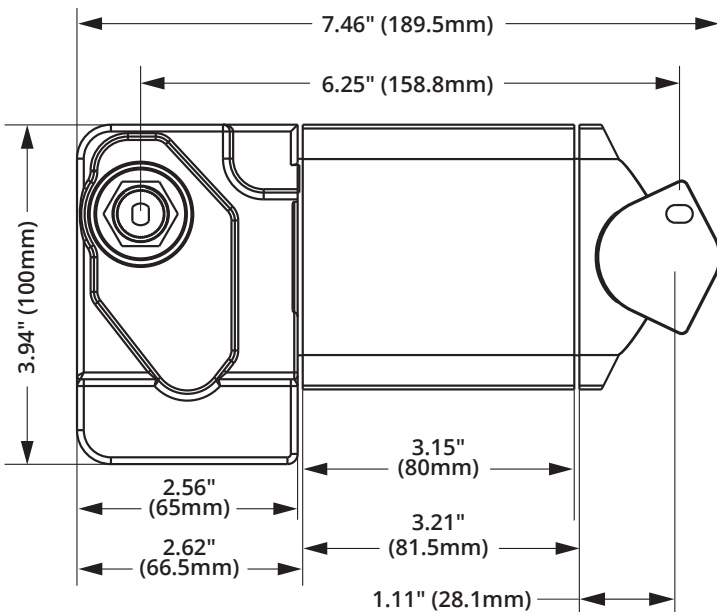



3 YEAR WARRANTY
CE

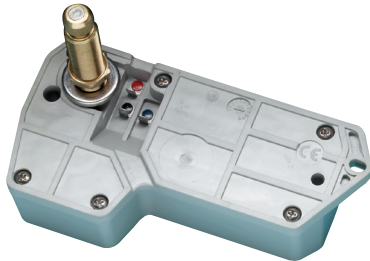

1000 Waterproof Wiper Motor

- Powers 18" Deluxe arm and 18" Deluxe blade combination at sweep sets of 80° or less (not compatible with pantograph arms)
- Powers 16" Deluxe arm and 16" Deluxe blade combinations at a sweep set of 110° (not compatible with pantograph arms)
- Factory pre-set sweep of 80° or 110° adjustable to 50°, 65°, 80°, or 110°
- .625" diameter shaft (16 mm)
- Fully sealed waterproof housing made of UV stabilized, high-temperature, high-impact thermoplastic
- 12V heavy-duty motor with anti-rotation drive shaft
- Knurled drive shaft and solid brass arm drive nut
- Coast to park with adjustable right or left self parking
- Retail version includes 5A fuse and holder (on/off switch not included)
- RF shielded circuitry
- Weight: 1.75 lbs
- Available in two (2) shaft lengths: 1.5" and 2.5" (includes .5" length of knurled arm fitting)
- Measures approximately 6.625" L x 3.375" W x 2" D
- Stall torque: 55 in-lbs (63 kgf/cm; 6.2 Nm)
- Stall current: 9.8A-10.0A
- No load current: 0.8A-1.2A

Related Products



Intermittent Wiper Motor Controller
page 70

Description	Voltage	Sweep	Part #	OEM #
1.5" Shaft	12V	65°	—	36161
		80°	36180	—
		110°	36110	36111
2.5" Shaft	12V	65°	—	37161
		80°	37180	37181
		110°	37110	37111
2.5" Shaft Kits	12V	80°	37100	—
		110°	37200	—

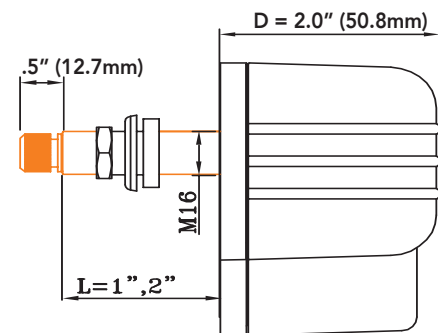
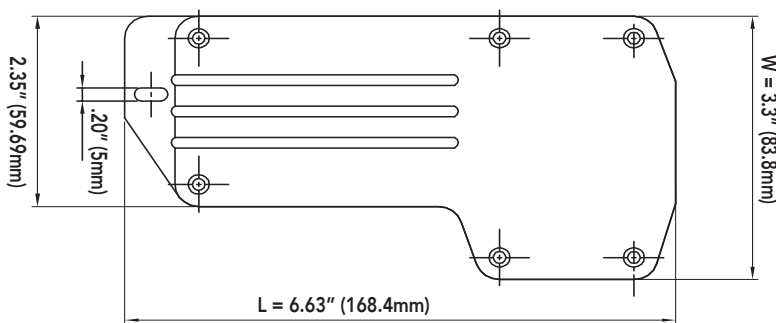

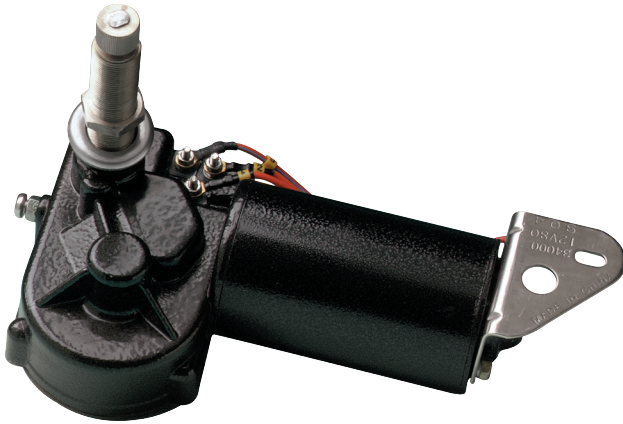

3 YEAR WARRANTY
CE

MRV Wiper Motor

- Easily powers 22" x 22" deluxe arm/blade combinations, or a 20" x 20" premier arm/blade combination at sweep sets of 80° or less
- Factory pre-set sweep of 80° or 110° adjustable from 40° to 110° in 10° increments
- .625" diameter shaft (16 mm)
- Available in three (3) shaft lengths: 1.5", 2.5" and 3.5" (includes .5" length of knurled arm fitting)
- Corrosion-resistant casing
- Heavy-duty motor with right angle drive
- Two-speed motor, can be operated as one speed
- Solid brass knurled drive nut with brass and stainless steel drive shaft
- Adjustable right or left self parking, coast to park
- Retail version includes 5A fuse and holder
- Stainless steel fasteners and mounting bracket
- Use with three-position switch (not included)
- Compact size – 7.625" L x 4" W x 2" D
- Stall torque: 109 in-lbs (125 kgf/cm: 12.3 Nm)
- Stall current: 11.5A–13.0A
- No load current: 0.5A–1.2A

Related Products



Intermittent Wiper Motor Controller
 page 70

Description	Voltage	Sweep	Item#	OEM #
1.5" Shaft	12V	80°	34001	38001
		110°	34011	38011
2.5" Shaft	12V	80°	34000	38000
		110°	34010	38010
		24V	110°	34210
3.5" Shaft	12V	80°	34005	38005
		110°	34015	—

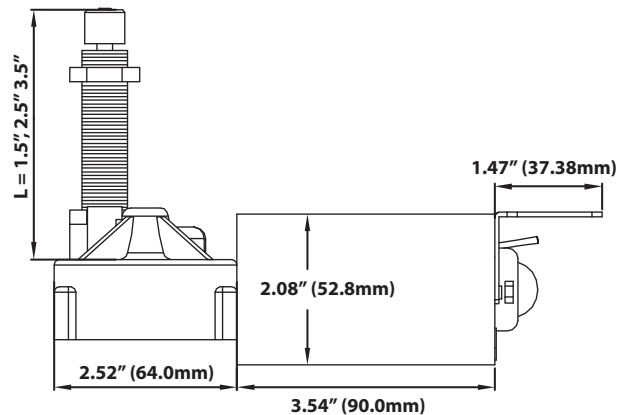
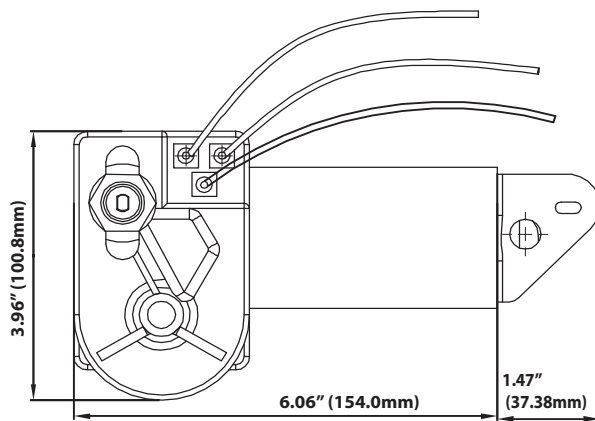

MRV Wiper Motor Cover

- Constructed of white ABS plastic
- Easily installed

Description	Part #	OEM #
White	33025	33125

WMW Wiper Motor

Windshield Mount: .375" shaft diameter

- Powers up to 14" x 14" arm/blade combinations
- Water-resistant sealed motor
- Chrome-plated brass case and shaft housing
- Stainless steel front plate and wiper shaft
- Maximum current draw: 2A
- Shaft diameter: .375"
- For external use in open cabin boats
- Dimensions: 4.25" L x 2.75" W x 3.5" D

Description	Voltage	Sweep	OEM #
2.5" Shaft	12V	110°	35010

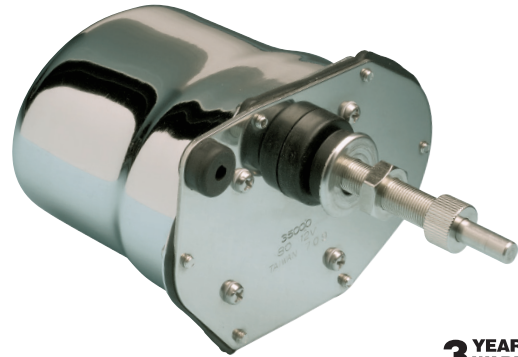

3 YEAR WARRANTY

STD Wiper Motor

Windshield Mount: .375" shaft diameter

Deck Mount: .5" shaft diameter

- Deck mount version includes deck mount adapter kit (33000)
- Powers up to 14" x 14" arm/blade combinations
- Corrosion-proof aluminum alloy case with black crackle finish
- Base & mounting plates are chrome plated naval brass
- Maximum current draw: 2A
- 80° or 110° adjustable sweep, adjustable right or left self-parking
- Shaft diameter: .375" windshield mount, .5" deck mount
- Dimensions: 3.875" L x 2.25" W x 3.5" D

Description	Voltage	Sweep	Part #
2.5" Shaft	12V	80°	35040



3 YEAR WARRANTY

Intermittent Wiper Motor Controller

- Single-speed and dual-speed options
- Allows for the control of single motor systems, and synchronized control of dual motor systems
- Intuitive automotive-style functionality—features adjustable intermittent settings, adjustable continuous settings, and washer system operation
- IP67—Potted case for harsh environment durability (see inside back cover)
- Includes Contura Switch, SPDT (On)-Off-(On) (retail only)
- Easy to install with 1/4" spade connectors
- Reverse polarity protection
- Compatible with 12V and 24V DC motors

Description	Part #	OEM #
Single Speed	76090	76190
Dual Speed	76080	76180

LEARN MORE
Wiper Motor
Controller Video



Visit Marinc on
YouTube.com



76080



3 YEAR WARRANTY

WMW Wiper Motor Kit

Windshield Mount: .375" shaft diameter

- Powers up to 14" x 14" arm/blade combinations
- Water-resistant sealed motor
- Chrome-plated brass case and shaft housing
- Stainless steel front plate and wiper shaft
- Maximum current draw: 2A
- Shaft diameter: .375"
- For external use in open cabin boats
- Dimensions: 4.25" L x 2.75" W x 3.5" D

Kit includes:

- WMW wiper motor
- 11.5" Deluxe stainless steel curved blade (33004)
- Deluxe adjustable (6.75" to 10.5") stainless steel arm (33006AS)

Description	Voltage	Sweep	Part #	OEM #
2.5" Shaft	12V	80°	30000	—
2.5" Shaft	12V	110°	30002	—



3 YEAR WARRANTY

STD Wiper Motor Kit

Windshield Mount: .375" shaft diameter

Deck Mount: .5" shaft diameter

- Deck Mount version includes deck mount adapter kit (33000)
- Powers up to 14" x 14" arm/blade combinations
- Corrosion-proof aluminum alloy case with black crackle finish
- Base & mounting plates are chrome plated naval brass
- Maximum current draw: 2A
- 80° or 110° adjustable sweep, adjustable right or left self-parking
- Shaft diameter: .375" windshield mount, .5" deck mount
- Dimensions: 3.875" L x 2.25" W x 3.5" D

Kit includes:

- STD wiper motor (recommended for interior installations only)
- 11.5" Deluxe stainless steel curved blade (33004)
- Deluxe adjustable (6.75" to 10.5") stainless steel arm (33006AS)

Description	Voltage	Sweep	Part #	OEM #
2.5" Shaft	12V	80°	—	32000
		110°	—	32002
3.5" Shaft	12V	80°	—	32001



3 YEAR WARRANTY

500 Wiper Kit

Windshield Mount: .5" shaft diameter

Kit includes:

- 500 Waterproof wiper motor
- 11.5" Deluxe stainless steel curved blade (33004)
- Deluxe adjustable (6.75" to 10.5") stainless steel arm (33006AS)

Description	Voltage	Sweep	OEM #
2.5" Shaft	12V	80°	30004
2.5" Shaft	12V	110°	30005



Hand-operated Wiper Blade

- Chrome-plated brass handle
- Includes stainless steel 7-1/2" to 12" adjustable wiper arm, 11" blade, and all parts for installation
- Economical—an inexpensive alternative to wiper motor kit
- Requires 7/16" diameter hole for installation
- Can be installed up to 7/8" thick material
- For use on flat windshields only

Description	Part #	OEM #
Full Kit	31000	—
Replacement Blade	—	33101

Wiper Arms

Wiper arms are available in Deluxe and Premier styles and the primary construction material in all wiper arms is stainless steel. The Deluxe arms are used on Standard and Heavy-Duty motors. When choosing arms (and blades) it is very important to use only the recommended lengths for the motor that you are using.

The arms are available in a wide range of sizes, in both black and stainless-steel finish, and regular and pantographic models. Pantographic arms use a set of two arms joined together to give a flatter and somewhat wider sweep pattern. The Deluxe arms are available in a polished stainless-steel finish or a black powder-coated finish. Premier arms are the top of the line product in this category, utilizing heavy-duty stainless-steel tubing and components, and they can only be used with the Heavy-Duty motors.

Premier arms are also available as "wet arm" versions, with the water hose and sprayer nozzle built into the wiper arm. All that is needed is a water delivery system that the arm can be tied into. For those wanting a windshield washer system for the Deluxe arms, there is a complete washer kit system that is made especially to fit the Deluxe arms.

Wiper Arm Compatibility Chart

Style	Wet/ Dry	Length (adjustable)	Color	Material	Part #	OEM #	Motor Compatibility Chart					
							2.5	3000	1.5	1000	MRV	
Premier												
single	wet	15"-20"	stainless	stainless	33084W	33184W	✓	✓	✓	—	✓	
single	wet	20"-25"	stainless	stainless	33086W	33186W	✓	✓	—	—	—	
pantographic	dry	12"-17"	stainless	stainless	33090	33190	✓	✓	✓	—	✓	
pantographic	dry	17"-22"	stainless	stainless	33092	33192	✓	✓	—	—	max 20"	
pantographic	dry	22"-26"	stainless	stainless	33094	33194	✓	✓	—	—	—	
pantographic	wet	12"-17"	stainless	stainless	33090W	—	✓	✓	✓	—	✓	
pantographic	wet	17"-22"	stainless	stainless	33092W	33192W	✓	✓	—	—	max 20" ≤ 80"	
Deluxe Adjustable												
single	dry	6.75"-10.5"	stainless	stainless	33006A	33106A	✓	✓	✓	✓	✓	
single	dry	10"-14"	stainless	stainless	33007A	33107A	✓	✓	✓	✓	✓	
single	dry	14"-20"	stainless	stainless	33010A	33110A	✓	✓	✓	max 18" ≤ 80° max 16" @ 110°	✓	
single	dry	10"-14"	black	stainless	33012A	33112A	✓	✓	✓	✓	✓	
single	dry	14"-20"	black	stainless	33014A	33114A	✓	✓	✓	max 18" ≤ 80° max 16" @ 110°	✓	
single	dry	18"-24"	black	stainless	33070A	33170A	✓	✓	—	—	max 22"	
Deluxe Pantographic												
pantographic	dry	12"-17"	black	stainless	33032A	33132A	✓	✓	✓	—	✓	
pantographic	dry	17"-22"	black	stainless	33037A	33137A	✓	✓	✓	—	✓	

Premier Stainless Steel Pantographic Dry Arms

- Heavy-duty component design for use with most Marinco® motors
- Stainless steel construction
- Features "articulating/bend back" design that locks arm in upright position for windshield cleaning
- Motor shaft mount with notched teeth



Pantographic

Style	Wet/Dry	Length (adjustable)	Color	Material	Part #	OEM #
pantographic	dry	12"-17"	stainless	stainless	33090	33190
pantographic	dry	17"-22"	stainless	stainless	33092	33192
pantographic	dry	22"-26"	stainless	stainless	33094	33194

Pantographic wiper arms will only function properly with wiper motor sweep angles 80° or less

Premier Stainless Steel Wiper Wet Arms

- Heavy-duty component design for use with most Marinco® motors
- Features “articulating/bend back” design that locks arm in upright position for windshield cleaning
- Built-in wet arm system that allows for a clean and easy installation of a washer system
- Black PVC hose runs up the center of the arm and ends in an adjustable four-nozzle fixture that is an integral part of the wiper arm itself



Style	Wet/Dry	Length (adjustable)	Color	Material	Part #	OEM #
single	wet	15"-20"	stainless	stainless	33084W	33184W
single	wet	20"-25"	stainless	stainless	33086W	33186W
pantographic	wet	17"-22"	stainless	stainless	33092W	33192W

Pantographic wiper arms will only function properly with wiper motor sweep angles 80° or less

Deluxe Adjustable Wiper Arm

- All arms are stainless steel
- Arm has “articulating/bend-back” feature
- Motor shaft mounting has additional set screw clamping



Style	Wet/Dry	Length (adjustable)	Color	Material	Part #	OEM #
single	dry	6.75"-10.5"	stainless	stainless	33006A	33106A
single	dry	10"-14"	stainless	stainless	33007A	33107A
single	dry	14"-20"	stainless	stainless	33010A	33110A
single	dry	10"-14"	black	stainless	33012A	—
single	dry	14"-20"	black	stainless	33014A	33114A
single	dry	18"-24"	black	stainless	33070A	33170A

Deluxe Adjustable Pantographic Arm

- For Use with 2.5, 1.5 and MRV Motors
- Stainless steel
- Arm has “articulating/bend-back” feature
- Motor shaft mounting has additional set screw clamping



Style	Wet/Dry	Length (adjustable)	Color	Material	Part #	OEM #
pantographic	dry	12"-17"	black	stainless	33032A	33132A
pantographic	dry	17"-22"	black	stainless	33037A	33137A

Wiper Blade Selection Charts

Step 1: Find the type and part number of wiper arm you have along the left side of the chart.

Step 2: Follow along to the right until you match up with the type and length of wiper blade you want.

Step 3: The bold number is the part number and the lighter number is the OEM number (if available).



	Color/ Material	Length	Deluxe Blades							Black/ Stainless					
			Stainless/ Stainless	12"	14"	16"	18"	20"	22"	24"	26"	12"	14"	16"	18"
Premier Wiper Arms	Single Arm														
	33084W 33184W	wet	34012S 34112S	34014S 34114S	34016S 34116S	34018S 34118S	34020S 34120S	34022S 34122S	34024S 34124S	34026S 34126S	34012B 34112B	34014B 34114B	34016B 34116B	34018B 34118B	
	33086W 33186W	wet	34012S 34112S	34014S 34114S	34016S 34116S	34018S 34118S	34020S 34120S	34022S 34122S	34024S 34124S	34026S 34126S	34012B 34112B	34014B 34114B	34016B 34116B	34018B 34118B	
	Pantograph Arm														
	33090 33190	dry	34012S 34112S	34014S 34114S	34016S 34116S	34018S 34118S	34020S 34120S	34022S 34122S	34024S 34124S	34026S 34126S	34012B 34112B	34014B 34114B	34016B 34116B	34018B 34118B	
	33090W 33190W	wet	34012S 34112S	34014S 34114S	34016S 34116S	34018S 34118S	34020S 34120S	34022S 34122S	34024S 34124S	34026S 34126S	34012B 34112B	34014B 34114B	34016B 34116B	34018B 34118B	
	33092 33192	dry	34012S 34112S	34014S 34114S	34016S 34116S	34018S 34118S	34020S 34120S	34022S 34122S	34024S 34124S	34026S 34126S	34012B 34112B	34014B 34114B	34016B 34116B	34018B 34118B	
	33092W 33192W	wet	34012S 34112S	34014S 34114S	34016S 34116S	34018S 34118S	34020S 34120S	34022S 34122S	34024S 34124S	34026S 34126S	34012B 34112B	34014B 34114B	34016B 34116B	34018B 34118B	
	33094 33194	dry	34012S 34112S	34014S 34114S	34016S 34116S	34018S 34118S	34020S 34120S	34022S 34122S	34024S 34124S	34026S 34126S	34012B 34112B	34014B 34114B	34016B 34116B	34018B 34118B	
	33094W 33194W	wet	34012S 34112S	34014S 34114S	34016S 34116S	34018S 34118S	34020S 34120S	34022S 34122S	34024S 34124S	34026S 34126S	34012B 34112B	34014B 34114B	34016B 34116B	34018B 34118B	
	Deluxe Wiper Arms	Single Arm													
		33006A 33106A	dry	34012S 34112S	34014S 34114S	34016S 34116S	34018S 34118S	34020S 34120S	34022S 34122S	34024S 34124S	34026S 34126S	34012B 34112B	34014B 34114B	34016B 34116B	34018B 34118B
		33007A 33107A	dry	34012S 34112S	34014S 34114S	34016S 34116S	34018S 34118S	34020S 34120S	34022S 34122S	34024S 34124S	34026S 34126S	34012B 34112B	34014B 34114B	34016B 34116B	34018B 34118B
		33010A 33110A	dry	34012S 34112S	34014S 34114S	34016S 34116S	34018S 34118S	34020S 34120S	34022S 34122S	34024S 34124S	34026S 34126S	34012B 34112B	34014B 34114B	34016B 34116B	34018B 34118B
33012A 33112A		dry	34012S 34112S	34014S 34114S	34016S 34116S	34018S 34118S	34020S 34120S	34022S 34122S	34024S 34124S	34026S 34126S	34012B 34112B	34014B 34114B	34016B 34116B	34018B 34118B	
33014A 33114A		dry	34012S 34112S	34014S 34114S	34016S 34116S	34018S 34118S	34020S 34120S	34022S 34122S	34024S 34124S	34026S 34126S	34012B 34112B	34014B 34114B	34016B 34116B	34018B 34118B	
33070A 33170A		dry	34012S 34112S	34014S 34114S	34016S 34116S	34018S 34118S	34020S 34120S	34022S 34122S	34024S 34124S	34026S 34126S	34012B 34112B	34014B 34114B	34016B 34116B	34018B 34118B	
Pantograph Arm															
33032A 33132A		dry	34012S 34112S	34014S 34114S	34016S 34116S	34018S 34118S	34020S 34120S	34022S 34122S	34024S 34124S	34026S 34126S	34012B 34112B	34014B 34114B	34016B 34116B	34018B 34118B	
33037A 33137A		dry	34012S 34112S	34014S 34114S	34016S 34116S	34018S 34118S	34020S 34120S	34022S 34122S	34024S 34124S	34026S 34126S	34012B 34112B	34014B 34114B	34016B 34116B	34018B 34118B	

Pantographic wiper arms will only function properly with wiper motor sweep angles 80° or less

Wiper Blades

Deluxe and Hybrid wiper blades are offered in different sizes and styles to fit all the different types of wiper arms. Standard styles have plastic frame construction and marine grade rubber squeegees.

Deluxe blades have stainless steel frame construction and high-end silicone rubber squeegees. This style has a multiple frame construction, allowing for equal pressure of the entire length of the blade and silicone rubber squeegees that are durable and create a smoother wiping motion.

Hybrid blades are designed from a multi-material construction of an electro coated galvanized steel frame, with a durable polycarbonate shell. This along with a graphite-coated natural rubber squeegee make this an excellent marine grade construction. For maximum performance of all blade styles, replacement of wiper blades is recommended every 6 months.



Deluxe Blades (cont)				Hybrid Blades						
Black/ Stainless (cont)				Black/ Polymer						
20"	22"	24"	26"	12"	14"	16"	18"	20"	22"	24"
34020B 34120B	34022B 34122B	34024B 34124B	34026B 34126B	32012B 32112B	32014B 32114B	32016B 32116B	32018B 32118B	32020B 32120B	32022B 32122B	32024B 32124B
34020B 34120B	34022B 34122B	34024B 34124B	34026B 34126B	32012B 32112B	32014B 32114B	32016B 32116B	32018B 32118B	32020B 32120B	32022B 32122B	32024B 32124B
34020B 34120B	34022B 34122B	34024B 34124B	34026B 34126B	32012B 32112B	32014B 32114B	80° only	80° only	80° only		
34020B 34120B	34022B 34122B	34024B 34124B	34026B 34126B	32012B 32112B	32014B 32114B	80° only	80° only	80° only		
34020B 34120B	34022B 34122B	34024B 34124B	34026B 34126B	32012B 32112B	32014B 32114B	32016B 32116B	32018B 32118B	32020B 32120B	32022B 32122B	80° only
34020B 34120B	34022B 34122B	34024B 34124B	34026B 34126B	32012B 32112B	32014B 32114B	32016B 32116B	32018B 32118B	32020B 32120B	32022B 32122B	80° only
34020B 34120B	34022B 34122B	34024B 34124B	34026B 34126B	32012B 32112B	32014B 32114B	32016B 32116B	32018B 32118B	32020B 32120B	32022B 32122B	32024B 32124B
34020B 34120B	34022B 34122B	34024B 34124B	34026B 34126B	32012B 32112B	32014B 32114B	32016B 32116B	32018B 32118B	32020B 32120B	32022B 32122B	32024B 32124B
34020B 34120B	34022B 34122B	34024B 34124B	34026B 34126B	32012B 32112B	32014B 32114B	32016B 32116B				
34020B 34120B	34022B 34122B	34024B 34124B	34026B 34126B	32012B 32112B	32014B 32114B	32016B 32116B	32018B 32118B	32020B 32120B		
34020B 34120B	34022B 34122B	34024B 34124B	34026B 34126B	32012B 32112B	32014B 32114B	32016B 32116B	32018B 32118B	32020B 32120B	32022B 32122B	32024B 32124B
34020B 34120B	34022B 34122B	34024B 34124B	34026B 34126B	32012B 32112B	32014B 32114B	32016B 32116B	32018B 32118B	32020B 32120B	32022B 32122B	32024B 32124B
34020B 34120B	34022B 34122B	34024B 34124B	34026B 34126B	32012B 32112B	32014B 32114B	32016B 32116B	32018B 32118B	32020B 32120B	32022B 32122B	32024B 32124B
34020B 34120B	34022B 34122B	34024B 34124B	34026B 34126B	32012B 32112B	32014B 32114B	32016B 32116B	32018B 32118B	32020B 32120B	32022B 32122B	32024B 32124B
34020B 34120B	34022B 34122B	34024B 34124B	34026B 34126B	32012B 32112B	32014B 32114B	32016B 32116B	32018B 32118B	32020B 32120B		
34020B 34120B	34022B 34122B	34024B 34124B	34026B 34126B	32012B 32112B	32014B 32114B	32016B 32116B	32018B 32118B	32020B 32120B	32022B 32122B	32024B 32124B

Deluxe Stainless Steel Wiper Blades

- Works well on curved or flat windshields
- All stainless steel construction
- Marine grade silicone squeegee



Length	Color	Material	Part #	OEM #
12"	stainless	stainless	34012S	34112S
14"	stainless	stainless	34014S	34114S
16"	stainless	stainless	34016S	34116S
18"	stainless	stainless	34018S	34118S
20"	stainless	stainless	34020S	34120S

Length	Color	Material	Part #	OEM #
22"	stainless	stainless	34022S	34122S
24"	stainless	stainless	34024S	34124S
26"	stainless	stainless	34026S	34126S



Length	Color	Material	Part #	OEM #
12"	black	stainless	34012B	34112B
14"	black	stainless	34014B	34114B
16"	black	stainless	34016B	34116B
18"	black	stainless	34018B	34118B
20"	black	stainless	34020B	34120B

Length	Color	Material	Part #	OEM #
22"	black	stainless	34022B	34122B
24"	black	stainless	34024B	34124B
26"	black	stainless	34026B	34126B

Hybrid Wiper Blades

Hybrid Multi-Material Construction. Electro coated galvanized steel frame, with durable polycarbonate shell.

- Designed for maximum flexibility to conform to all windshield shapes
- Marine grade construction will not rust or corrode
- Graphite-coated natural rubber squeegee for optimal wipe quality and durability
- Streamlined shape for reduced wind-lift
- Performance-tested to 500,000 cycles

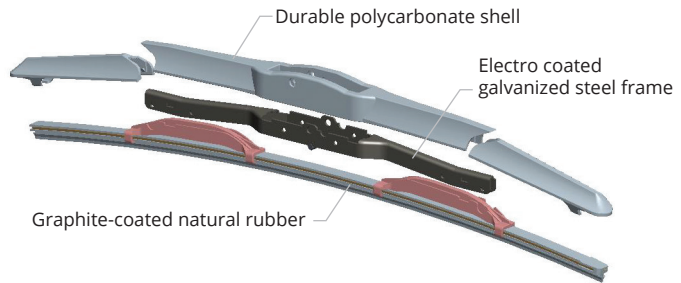

Length	Color	Material	Part #	OEM #
12"	black	hybrid	32012B	32112B
14"	black	hybrid	32014B	32114B
16"	black	hybrid	32016B	32116B
18"	black	hybrid	32018B	32118B
20"	black	hybrid	32020B	32120B

Length	Color	Material	Part #	OEM #
22"	black	hybrid	32022B	32122B
24"	black	hybrid	32024B	32124B

Classic Stainless Steel Straight Wiper Blades

- Replaces most standard blades in boats made before 1990
- Hook and catch style



Length	Color	Material	Part #
11"	stainless	stainless	33901
14"	stainless	stainless	33919

Note: NOT for use with currently offered arms

Add-On Windshield Washer Kits

- Can be used on new or existing Deluxe wiper arm and blade sets
- Kit includes parts to outfit two (2) wiper arms
- Sprayer fittings (kit includes two) each have four (4) adjustable brass nozzles to provide maximum spray coverage for most any windshield
- Plastic parts are numbered to make installation easy

Complete Kit

Includes:

- Water tank with mounting bracket
- 12V pump motor
- Under deck tee fitting
- Thru deck fitting and hardware
- Below deck clear tubing (16')
- Above deck black tubing (6')
- Large and small rivet clips
- Wiper arm clips
- Sprayer fittings with clamps

Description	Part #	OEM #
Complete Kit	33505	33515
Below Deck	—	33513
Above Deck	—	33517

Below Deck Kit

Includes:

- Water tank with mounting bracket
- 12V pump motor
- Under deck tee fitting
- Thru deck fitting and hardware
- Below deck clear tubing (16')

Above Deck Kit for One Small Arm

Includes:

- Small rivet clip
- Wiper arm clips
- Sprayer fitting with narrow clamp
- Thru deck fitting
- Above deck black tubing (6')



Intelligent Wiper Switch

Microcontroller based “intelligent” switch provides all necessary wiper motor functions in one small component.

- Settings for two (2) continuous speed functions and three (3) intermittent speed functions (2-, 4-, or 8-second delay)
- Washer system operation function
- Blinking LED lights in switch indicate operating function
- Works with 12V or 24V DC motors
- Fits standard switch size openings, requires 2.65"/67.5 mm depth
- Includes one (1) ten pole connector with female pins and two (2) female quick-connects

Description	Part #	OEM #
Single Motor	76030	76130



HORNS

Hidden Horns



81

Marinco®, the inventor of the first below-deck horn offers a complete line of below deck horn products.

Compact Horns



89

Marinco compact electric horns feature a low profile design and a lower frequency which provides a deeper sound.



HORNS

Electric Trumpet Horns



86

Classic design electric trumpet horns feature a lower frequency which provides a deeper sound.

Air Trumpet Horns

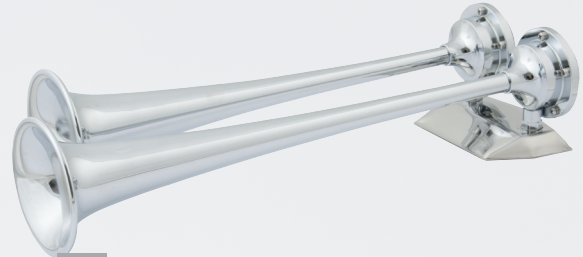

87

Classic design, featuring solid brass construction with a non-corrosive LEXAN polycarbonate diaphragm.



Marinco® Horns

Marinco is the leading supplier of horns to the marine industry, with over fifty years of experience in designing and manufacturing sound devices specifically for use in harsh marine environments. Stainless steel is used for all critical components such as trumpets, motor cover, diaphragms, and assembly and mounting hardware. In the case of the XLP trumpet horns, the horn is given extra protection through the complete over-molding of the internal motor cover housing. It is this extra process that provides the added protection needed to back up the five-year warranty.

Marinco offers a complete line of marine horn products designed to meet almost any need, including electric and air trumpet horns, compact horns, electric and air below deck horns, and a comprehensive line of drop-in horns with a wide assortment of grill options. After developing the first below deck horn for the marine industry in the late 1980's, the offering of that product line has continued to expand.

- Meets the ABYC Regulation #A23 for boats up to 12 meters
- Meets the U.S. Coast Guard's C.O.L.R.E.G.S. and U.S. Inland Navigation Rules, Annex III Regulations for boats up to 20 meters
- Listed in the NMMA's Certification Program Type Accepted
- Horns are set at a lower frequency to provide greater range as the sound travels across the water

Marinco Horn Relative Loudness Comparison Chart

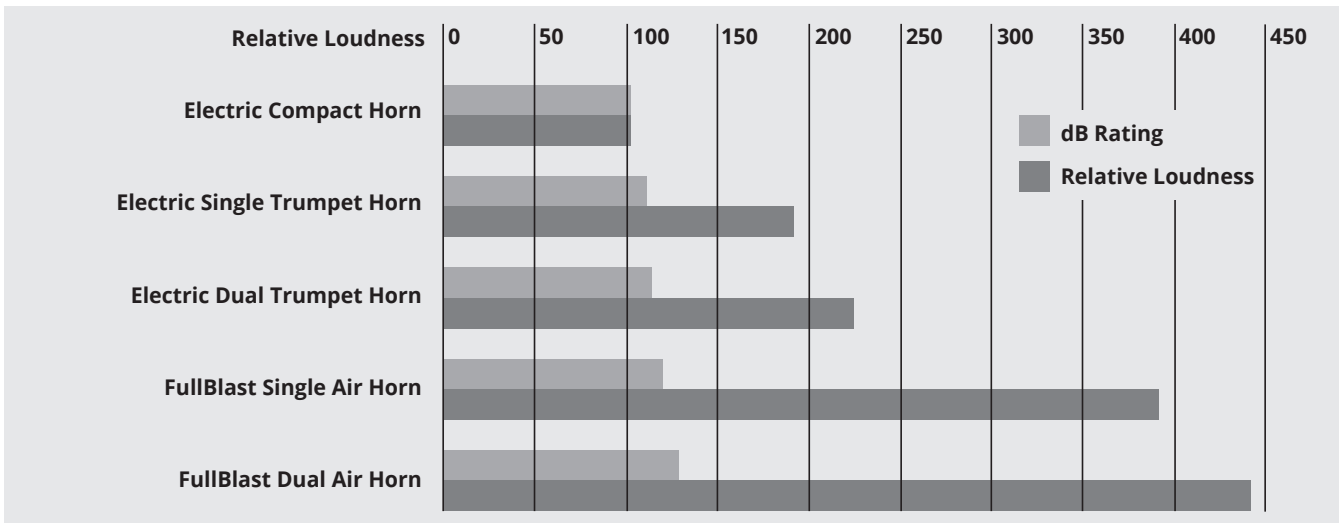

TECH TIP

EMI and Horns

In order to operate, an electric horn rapidly makes and breaks an electric circuit. This operation creates electromagnetic disturbance, which may cause electrical "noise" in communications equipment. Because a horn is only used temporarily, any interference in electronic equipment is stopped when the horn is turned off.

The International Marine Certification Institute (IMCI), which certifies boats to the European Community Regulations (CE), has determined that boats using electric horns can comply with CE requirements on electromagnetic compatibility provided the above message is given to the boat owners in their manual.

Marinco®, the inventor of the first below deck horns, offers a full line of below deck horn products. Concealed horns utilize an upright horn installation and a large grill opening to offer greater sound volume. Drop-in Hidden Horns use a fabric lined grill for water-resistant installations. The concealed trumpet horns are all air horns and provide the maximum amount of sound available in a below deck horn installation.

Marinco's Drop-in Hidden Horns combine a number of desired features into one unit including:

- Simple, drop-in installation
- Stylish snap-on grill with water-resistant fabric
- Authentic marine sound
- Easy aftermarket retrofit

Important: Please note the space requirement dimensions on some of the below deck models to ensure there is adequate room on the interior of the mounting area to house the horn assembly. Concealed horn models require a minimum 45° mounting angle to ensure proper drainage.

Low Profile Hidden Horn

With Black and White Grills

- New louder dB(A) rating: 111 at one meter
- Fundamental frequency: 360±20Hz
- 12V DC
- Easy installation: 2.75" diameter hole x 1" deep
- Maximum amp draw: 4A
- Comes with both white ASA and black ABS screw-in grills
- Grills have water resistant fabric liners
- Mounts from the outside, grill screws on for easy install
- Easy retrofit

Part # 10080

Without Grill

- Same as 10080 without grill
- When purchasing bulk version, grill must be ordered separately

OEM # 11080



Grills for Low Profile Hidden Horn

- Water resistant fabric liner
- Screw-in
- 4" from hole to hole

Type	Color	Vertical Style OEM #	Horizontal Style OEM #	Dimensions
Screw-in	White ASA	11080SC-W	11187	5.25" x 3.375" x .75"
	Black ABS	11080SC-B	11188	5.25" x 3.375" x .75"
	Stainless Steel	11080SC-SS	—	5.25" x 3.375" x .75"



Stainless Steel Grill Cover

- Horizontal style grill design
- Installs over plastic horizontal style grills (11187, 11194, or 11188)
- Installation requires plastic grill
- Grill dimensions: 5.3125" W x 3.4375" H x .875" D

OEM # 11196 Stainless steel grill

OEM # 11096 Kit (includes: stainless steel grill cover and plastic screw-in grill (11187))

Drop-in Hidden Horns

With Black and White Grills

- dB(A) rating: 107 at one meter
- Fundamental frequency: 370±20Hz
- 12V DC
- Internal space requirements: 2" H x 3.375" W x 3.25" D
- Maximum amp draw: 4A
- Comes with both black ABS and white ASA snap-in grills
- Distinctive marine horn sound
- Enclosed sound unit
- Easy installation or retrofit, mounts from the outside

Part # 10079



Enclosed without Grill

- Same as 10079 without grill
- When purchasing 11079, grill must be ordered separately

OEM # 11079



Without Grill

- dB(A) rating: 105 at one meter
- Fundamental frequency: 430±20Hz
- 12V DC
- Internal space requirements: 2.25" H x 3.625" W x 3.5" D
- Maximum amp draw: 3A
- Mounts from the outside, horn grill snaps on for easy installation
- Easy retrofit
- Grill must be ordered separately

OEM # 11095

((Lower Frequency
for a Deeper Sound))



Grills for Drop-in Hidden Horns

- Water resistant fabric liner
- Choose between snap-in or screw-in.
- 4" from hole to hole

Type	Color	Vertical Style OEM #	Horizontal Style OEM #	Dimensions
Snap-In	White ASA	11079SN-W	11090	5" x 2.625" x .5"
	Black ABS	11079SN-B	11091	5" x 2.625" x .5"
	Chrome Plated ABS	—	11225	5" x 2.625" x .5"
Screw-In	White ASA	11079SC-W	11190	5" x 2.625" x .5"
	Black ABS	11079SC-B	11191	5" x 2.625" x .5"
	Chrome Plated ABS	—	11226	5" x 2.625" x .5"
	Stainless Steel	11079SC-SS	—	5" x 2.625" x .5"



Vertical Style
ASA/ABS

Vertical Style
Stainless Steel



Horizontal
Style



Stainless Steel Grill Cover

- Installs over screw-in plastic grill
- Requires plastic screw-in grill for installation
- Grill dimensions: 5.0625 W x 2.75 H x .5 D

OEM # 11124 Stainless steel grill

Under Deck Horn

- dB(A) rating: 110 at one meter
- Fundamental frequency: 420±20Hz
- 12V DC
- Dimensions: 4" W x 3.625" H x 5.75" L
- Permanently mounted grill to protect against water intrusion
- Available without 2-way weather pack connector pigtail

OEM # 11045 Horn without Pigtail

((Lower Frequency))
for a Deeper Sound



Pigtail not included

Mini Hidden Horn

- dB(A) rating: 105 at one meter
- Fundamental frequency: 430±20Hz
- 12V DC
- Dimensions: 3.25" W x 1.75" H x 3" L
- Maximum amp draw: 3A
- Type 304 stainless steel diaphragm
- This horn is not designed for installation in exposed areas

Part # 10031

OEM # 11031

((Lower Frequency))
for a Deeper Sound



With Grill Bracket

- Same horn motor as 11031 but includes grill mounting bracket
- Grill must be ordered separately

OEM # 11034



Grills for Mini Hidden Horn 11034

- Screw-In
- Black ABS version includes gasket for watertight seal
- 4" from hole to hole

Type	Color	Horizontal Style OEM #	Dimensions
Screw-In	Black ABS	11168	5" x 2.625" x .375"
	Stainless Steel	11088	5" x 2" x .25"



Horizontal Style

Electronic Horn

With White Grill

- 107 dB(A) at one meter
- Fundamental frequency: 550±100Hz
- 12V DC
- Internal space requirements: 2.25" W x 2.25" H x 2" D
- Grill dimensions: 4.875" W x 2.75" H x .5"D
- Draws less than one amp, maximum draw: 0.8A
- Electronic piezo horn sound
- One piece water resistant housing, grill is molded to horn
- Mounts in a standard 2.25" opening
- Stainless steel grill cover 11185 sold separately

Part # 10082

Stainless Steel Grill Cover for Electronic Horn 10082

- Grill dimensions: 4.9375" W x 2.8125" H x .5" D
- 4" from hole to hole

OEM # 11185



Concealed Single Mini Air Horn

- dB rating: 126 at one meter, 1/3 octave band
- Fundamental frequency: 630±15Hz
- 12V DC
- Internal space requirements: 13" H x 5" W x 3.75" D
- Air compressor dimensions: 2.625" D x 5" L
- Maximum amp draw: 20A
- Solid brass construction
- Includes compressor, air tubing, fittings, and hardware
- Grill must be ordered separately

OEM # 11059

Stainless Steel Grill for 11059

- Dimensions: 4.6875" H x 4.6875" W

OEM # 11064



Concealed Dual Trumpet Air Horn

- dB rating: 121 at one meter, 1/3 octave band
- Fundamental frequency: 375±15/315±15Hz
- 12V DC
- Internal space requirements: 10" W x 18.5" H x 3.75" D
- Air compressor dimensions: 5" L x 2.625" D
- Maximum amp draw: 20A
- Solid brass construction
- Can be mounted side by side with dual grill 11066 or separately with two single grills 11064
- Includes compressor, air tubing, fittings, and hardware

OEM # 11058

Stainless Steel Grill for 11058

- Dimensions: 9.375" W x 4.6875" H

OEM # 11066



MiniBlast™ Compact Electric Horns

- dB(A) rating: 106 at one meter (3 feet)
- Fundamental frequency: 430±20Hz
- 12V DC
- Dimensions: 4.375" L x 3.375" W x 2" H
- Maximum amp draw: 3A
- Long lasting, non-corrosive ASA plastic cover
- Sealed sound unit with stainless steel diaphragm
- Mounts in same hole pattern as the 10035 horn

White Part # 10099
 Black Part # 10098 OEM # 11098



Mini Compact Electric Horn

- dB(A) rating: 106 at one meter
- Fundamental frequency: 430±20Hz
- 12V DC
- Dimensions: 3" L x 3.25" W x 1.75" H
- Maximum amp draw: 3A
- Totally sealed sound unit
- Type 304 stainless steel cover, diaphragm, mounting bracket

Part # 10035
 OEM # 11035



Mini Twin Electric Horn

- dB(A) rating: 109 at one meter
- Fundamental frequency: 490±20/430±20Hz
- 12V DC
- Dimensions: 3" L x 8" W x 1.75" H
- Maximum amp draw: 6A
- Type 304 stainless steel covers, diaphragms, and mounting bracket

Part # 10001



International Shorty Horn

- dB(A) rating: 123 at one meter
- Fundamental frequency: 310±20 Hz
- 12V DC
- Dimensions: 4.25" L x 5" W x 6.5" H
- Maximum amp draw: 4A
- Stainless steel diaphragm and mounting bracket
- ABS, triple chrome-plated housing

Part # 10036



Single Trumpet Electric Horn

- dB(A) rating: 118 at one meter
- Fundamental frequency: 370±20Hz
- Dimensions: 16.5" L x 4" W x 4.75" H
- Maximum amp draw: 5A
- 100% stainless steel exterior
- Type 304 stainless steel diaphragm

12V Part # 10028XLP OEM # 11028XLP
 24V Part # 10017XL OEM # 11017XLP Max amp draw: 2.5A



((Lower Frequency))
 ((for a Deeper Sound))

5 YEAR
WARRANTY

Dual Trumpet Electric Horn

- dB(A) rating: 123 at one meter
- Fundamental frequency: 370±20/310±20Hz
- Dimensions: 18.5" L x 8" W x 5" H
- Maximum amp draw: 10A
- 100% stainless steel exterior
- Type 304 stainless steel diaphragm

12V Part # 10029XLP OEM # 11029XLP
 24V Part # 10018XL OEM # 11018XLP Max amp draw: 2.5A



5 YEAR
WARRANTY

Compact Single Trumpet Electric Horn

- dB(A) rating: 110 at one meter
- Fundamental frequency: 420±20Hz
- 12V DC
- Dimensions: 14" L x 3.5" W x 4" H
- Maximum amp draw: 3.5A
- Compact design makes it easier to install in smaller spaces
- 100% stainless steel exterior
- Type 304 stainless steel diaphragm

Part # 10010



((Lower Frequency))
 ((for a Deeper Sound))

Compact Dual Trumpet Electric Horn

- dB(A) rating: 115 at one meter
- Fundamental frequency: 420±20/370±20Hz
- 12V DC
- Dimensions: 16" L x 7.5" W x 4" H
- Maximum amp draw: 7A
- Compact design makes it easier to install in smaller spaces
- 100% stainless steel exterior
- Type 304 stainless steel diaphragm

Part # 10011



All of our air horns produce sound levels ranging between 120dB and 127dB, which means all of our air horns meet the ABYC and NMMA regulations for boats up to 20 meters/66 feet. Both 12V and 24V compressors are CE listed.

Single Trumpet Mini Air Horns

- dB rating: 126 at one meter, 1/3 octave band
- Fundamental frequency: 630±15Hz
- Dimensions: 9.5" L x 3.5" W x 3.5" H
- Maximum amp draw: 20A (12V DC)
- Solid brass construction with non-corrosive LEXAN® polycarbonate diaphragm
- Includes compressor, air tubing, fittings, and hardware

Chrome Plated	Part # 10107	OEM # 11107	Horn Only # 11117
White Epoxy Coated	Part # 10104	OEM # 11114	



Air Compressor included

Dual Trumpet Mini Air Horns

- dB(A) rating: 127 at one meter, 1/3 octave band
- Fundamental frequency: 630±15/525±15Hz
- Dimensions: 9.5" L x 5" W x 3.75" H
- Maximum amp draw: 20A (12V DC)
- Solid brass construction with non-corrosive LEXAN® polycarbonate diaphragm
- Includes compressor, air tubing, fittings, and hardware

Chrome Plated	Part # 10108
---------------	--------------



Air Compressor included

Single Trumpet Air Horns

- dB rating: 120 at one meter, 1/3 octave band
- Fundamental frequency: 315±15Hz
- Dimensions: 17" L x 3.75" W x 3.75" H
- Maximum amp draw: 20A (12V DC), 10A (24V DC)
- Solid brass construction with non-corrosive LEXAN® polycarbonate diaphragm
- Includes compressor, air tubing, fittings, and hardware

12V	Part # 10105
24V	Part # 10524

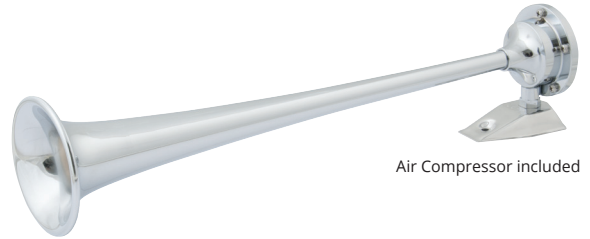

Air Compressor included

Dual Trumpet Air Horns

- dB rating: 121 at one meter, 1/3 octave band
- Fundamental frequency: 375±15/315±15Hz
- Dimensions: 17" L x 7" W x 3.75" H
- Maximum amp draw: 20A (12V DC), 10A (24V DC)
- Solid brass construction with non-corrosive LEXAN® polycarbonate diaphragm
- Includes compressor, air tubing, fittings, and hardware

12V, Chrome Plated	Part # 10106	OEM # 11106
12V, White Epoxy Coated	Part # 10122	
24V, Chrome Plated	Part # 10624	
24V, White Epoxy Coated	Part # 12224	OEM # 22224

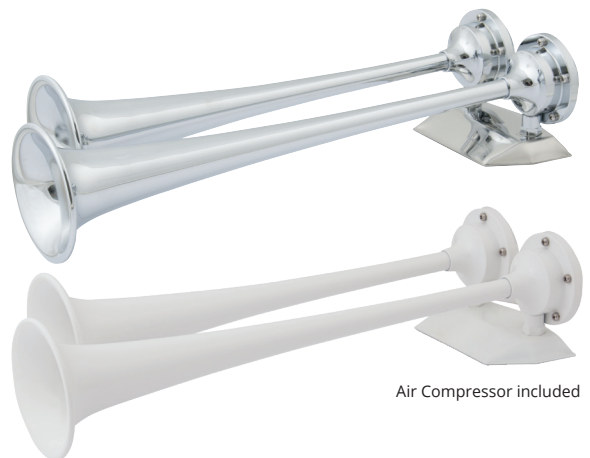

Air Compressor included

Air Compressor

- Replacement compressor fits all Marinco® and AFI™ Air Horns
- Maximum amp draw: 20A (12V DC), 10A (24V DC)
- Produces 9–11 PSI
- Dimensions: 2.625" D x 5" L
- Includes mounting bracket

12V	OEM # 10102
24V	OEM # 10224



LIGHTING

Precision Wireless Controlled Spotlight



90

Controlled by wireless remote control. Provides 370° sweep and 120° tilt. Designed for harsh marine environments, it is moisture, salt, and vibration resistant.

IP67 Stainless Steel Spot/Floodlight



91

Wireless remote communication. Stainless steel construction.

5" Stainless Steel Spot/Floodlight



92

Remote control / joystick operated stainless steel construction.



LIGHTING

IP67 Stainless Steel Spot/Floodlight



91

Features a 7", 12 LED array, and IP67 stainless construction. Creates approx. three times concentrated spot diameter while drawing roughly half the power of comparable halogen spotlights. Wireless communication using mounted bridge or hand held remote.

Deck Lamps



93

State-of-the-art free form lens reflector technology allows for 30% more light output than comparable 55W lamps.

Docking Lights



93

Compact flush mount docking lights for a variety of applications.



Proper lighting is necessary for safety and operational activities aboard vessels.



Precision Wireless Controlled Spotlight

- Universal 12V/24V circuit with bright 100W, H3 halogen bulb
- UV resistant, IP56 Weatherproof ABS housing and Lexan® lens
- O-ring sealed housing, designed for the harsh marine environment – moisture, salt, shock and vibration tested
- Universal snap-in mounting system (can be mounted upside down)
- Super-quiet, all-weather motor with limit stops provides a full range of coverage
- 370° sweep and 120° tilt (75° up and 45° down)
- One-touch auto sweep and S.O.S. function
- Wireless dash mount remote standard; (hard wired & handheld remotes are optional)
- Three-year limited warranty
- Available in white, black and chrome

3 YEAR WARRANTY

Bulb:	100 Watt, H3 Halogen
Power (Input voltage):	12V or 24V
Current draw (idle/in use):	0.03A / 7.0A
Peak Beam Intensity:	210,000 Cp
Peak Beam Distance:	917 ft (280 m)
Lux @ 66' (20 m):	525 Lux
Coverage at 66' (20 m):	132 sq ft (12 sq m)
Rotation:	370° (built in limit stops)
Tilt:	120° Tilt (75° up & 45° down)
Wireless range:	200 ft (65 m)
Dimensions:	7.5"W x 7.5"H x 9.25"D (19 x 19 x 23.5 cm)
Weight:	3.30 lbs (1.5 kg)
Housing material:	UV resistant PC/ASA
Lens material:	UV resistant Lexan®
operating temp range:	5°F–113°F (-15°C–45°C)
IP Rating:	IP56 (see inside back cover)



Spotlights

Description	Color	Part #	OEM #
12V/24V, 100 Watt	white	SPL-12W	—
12V/24V, 100 Watt	black	SPL-12B	—
12V/24V, 100 Watt	chrome	SPL-12C	—
12V, 100 Watt	white	—	SPL-12W.OEM
12V, 100 Watt	black	—	SPL-12B.OEM
12V, 100 Watt	chrome	—	SPL-12C.OEM
24V, 100 Watt	white	—	SPL-24W.OEM
24V, 100 Watt	black	—	SPL-24B.OEM
24V, 100 Watt	chrome	—	SPL-24C.OEM

Replacement Bulbs

Description	Part #
12V, H3 Halogen	202319
24V, H3 Halogen	202320



Remote Options

Part #	SPLR-2 (Included)	SPLR-1 (optional)	SPLR-3 (optional)
Remote Specifications	Wireless Communication Bridge Remote	Hand Held Bridge Remote	Wired Bridge Remote
Power	12V or 24V (hard wired)	CR2450 button cell battery	12V or 24V (hard wired)
Current draw (idle / in use)	negligible	negligible	negligible
Wireless range	200 ft (65m)	200 ft (65m)	—
Estimated battery life	—	> 40 hours (continuous use)	—
Dimensions	3.5"W x 2.25"H x .75"D 88 x 57 x 19 mm	2.0"W x 3.78"H x 1"D 51 x 96 x 25 mm	3.5"W x 2.25"H x .75"D 88 x 57 x 19 mm
Weight	2.12 oz (60g)	2.82 oz (80g)	2.12 oz (60g)
Housing material	UV resistant PC/ASA	UV resistant PC/ASA	UV resistant PC/ASA
Button material	Silicone (glow in the dark)	Silicone (glow in the dark)	Silicone (glow in the dark)
Operating temp range	5°F–113°F (-15°C–45°C)	5°F–113°F (-15°C–45°C)	5°F–113°F (-15°C–45°C)
IP Rating	IP53 (see inside back cover)	IP54 (see inside back cover)	IP53 (see inside back cover)



IP67 Halogen Stainless Steel Spot/Floodlight

- Wireless remote communication
- 316 stainless steel base, 304 stainless steel head
- 350° horizontal, 60° vertical two speed movement

Peak beam intensity	165,000 CP spot
Amp draw	Spot 8.3A, flood 7.5A @ 12V Spot 4.15A, flood 3.75A @ 24V
Power (Input voltage)	12V & 24V
Bulb	H4 halogen
Dimensions	9.875"H x 4.75"W x 8.35"L
Weight	6 lbs.
IP Rating	IP67 (see inside back cover)

Description	Part #
12V Spot/Flood with Remote (22250-R)	22050A
12V Spot/Flood Only	22051A
24V Spot/Flood with Remote (22350-R)	22150A
24V Spot/Flood Only	22151A



Remote Options

Part #	22250-R	22350-R	22250-HH
Voltage	12V	24V	12/24V
Power	12V DC	24V DC	Battery: L1028F Alkaline 12V
Remote Specifications	Wireless Communication Bridge Remote		Hand Held Bridge Remote
Wireless range	100 ft (30m)		100 ft (30m)
Dimensions	2.2"W x 3.65"H x 0.9"D		2.25"W x 3.95"H x 1.2"D
Housing material	ASA		ASA
Button material	Silicone (glow in the dark)		Silicone (glow in the dark)



3 YEAR WARRANTY

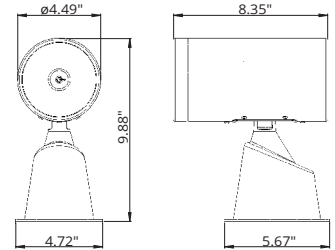

IP67 LED Stainless Steel Spotlight

- Wireless remote communication
- 316 stainless steel base, 304 stainless steel head
- 350° horizontal, 60° vertical two speed movement

Light Output	92,000 CD
Amp Draw	3A @12V DC 1.5A @24V DC
Power (Input voltage)	12V or 24V DC
# of LEDs	12
Dimensions	9.875"H x 4.75"W x 8.35"L
Weight	11.36 lbs (5.2 kg)
IP Rating	IP67 (see inside back cover)

Description	Part #
12V Spotlight with Remote (23250-R)	23050A
12V Spotlight Only	23051A
24V Spotlight with Remote (23350-R)	23150A
24V Spotlight Only	23151A



Remote Options

Part #	23250-R	23350-R	23250-HH
Voltage	12V	24V	12/24V
Power	12V DC	24V DC	Battery: L1028F Alkaline 12V
Remote Specifications	Wireless Communication Bridge Remote		Hand Held Bridge Remote
Wireless range	100 ft (30m)		100 ft (30m)
Dimensions	2.2"W x 3.65"H x 0.9"D		2.25"W x 3.95"H x 1.2"D
Housing material	ASA		ASA
Button material	Silicone (glow in the dark)		Silicone (glow in the dark)



3 YEAR WARRANTY

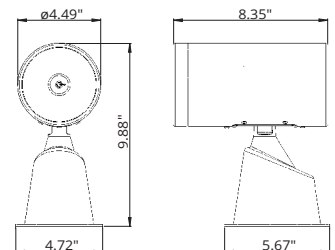

5" Stainless Steel Spot/Floodlight

- Remote control, joystick operation
- 316 stainless steel base, 304 stainless steel head
- Light can be directed manually without damaging motors
- One year warranty

Description	Part #
Spot/Flood Kit	22040A
Spot/Flood Only	22041A

Spot Power:	72,000 CP
Flood Power:	30,000 CP
Amp Draw:	7A
Operation:	12V Incandescent
Bulb:	Replaceable Incandescent
Lamp Dimensions:	9.5" H x 4.5" W x 7.5" L
Base Dimensions:	5.5" L x 3.5" W
Weight:	6 lbs (2.7 kg)
Joystick requires:	2.75" installation hole



Spot/Flood kit includes joystick control and 15' wiring cable with easy to install plug ends

Replacement Bulb

- 12V Incandescent

Part # 22014-P

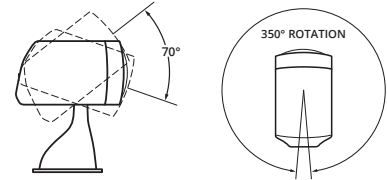

Spotlight Parts & Accessories

Stainless Steel Spot/Flood Parts and Accessories

Part #	Oval Panel	Rectangular Control	Replacement Bulb Kit
22040A	22240-R	22208A	22014-P
22041A	22240-R	22208A	22014-P

Beamer™ Parts and Accessories

Part #	Control Panel	Dual Station Control Kit	Replacement Bulb Kit	Wires in Cable
500, 500A	729823-P	729823-P	729493	1
501, 501A	729825	729825	729493	Wireless
502-1	U-3605	—	729493	5
503, 503A	729829-P	729830-P	729494	6



M100 Remote Halogen Spot Parts and Accessories

Part #	Joystick Control
22200	22209
22201	22209

Cables

Length	Replacement Male to Male
25 ft	22011A-P
35 ft	22012A-P

Use with: 22040A, 22041A, 22044, 22045, 22200 or 22201 Lights



Universal Halogen Deck Lamps

State-of-the-art free form lens reflector technology allows for 30% more light output than comparable 55W lamps. Universal mounting brackets and compact size make for easy installation anywhere. Lamp housing is made of UV stabilized plastic and all hardware is 316 chrome plated stainless steel. Includes 12V, 55W halogen bulb and is 24V, 70W compatible.

Bulbs:	Replaceable H3 12V 55W/H3 24V 70W
Dimensions:	3.75" H x 3.375" W x 5.5" L
Mounting Height:	4" with bracket

- Part # ML-005BW/DSP OEM # ML-005BW-STC black
- Part # ML-005WW/DSP OEM # ML-005WW-STC white



Flush Mount Deck Lamp

In addition to our highly popular conventional halogen deck lamps, we now offer a flush mount version. Ideally suited for fiberglass hardtop installations and allows for a very clean and finished installation. Free Form lens reflector technology guarantees maximum output. Lamp is completely waterproof and constructed of impact resistant UV stable plastic. Comes complete with 12V 55W halogen H3 bulb. Also suitable for 24V 70W bulbs.

Bulbs:	Replaceable H3 12V 55W/H3 24V 70W
Dimensions:	3.375" H x 1.5" W x 5.625" L
Cutout:	3" hole

- Part # ML-005NWW



Flush Mount Docking Lights—Convex Lens

Compact flush mount docking lights for a variety of applications. Easy to install through a 2" hole. Ideal for Pontoon and Deck boat docking lamps, spreader lamps or rear docking lamps for motor homes. Features a high performance convex lens with a 12V 37.5W halogen bulb for optimum performance. Available with and without stainless steel frame. Pigtail required.

Bulbs:	Replaceable #893 12V 37.5W Halogen
Dimensions:	ø = 2-1/2" Frame thickness: 7/8" Overall depth: 2-7/8" Mounting depth: 2"
Mounting Depth:	2"

- Part # M051B With out frame
- Part # M051B-SS Stainless frame
- Part # 11-004-N Pigtail for M051B and M051B-SS



Flush Mount Docking Lights—Flat Lens

Compact flush mount docking lights for a variety of applications. Easy to install through a 2" hole. Ideal for Pontoon and Deck boat docking lamps, spreader lamps or rear docking lamps for motor homes. Features a high performance free form reflector with a 12V 35W halogen bulb for optimum performance. Available with and without stainless steel frame.

Bulbs:	Replaceable MR16 12V 35W Halogen
Dimensions:	ø = 2-1/2" Frame thickness: 7/8" Overall depth: 2-7/8" Mounting depth: 2"
Mounting Depth:	2"

- Part # M051A-SS Stainless frame

VENTILATION

Day/Night Solar Vent



98

Day/Night solar vents offer 24-hour ventilation in a compact footprint. The new design can be removed from the deck and features LED lights and additional controls that are accessed from the cabin.

MiniVent 1000



99

The MiniVent 1000 is the smallest and most economical solar vent in the Marinco® line. At just 7" in diameter and approximately 1-3/4" high, the MiniVent 1000 is compact yet effective. This solar powered model is an exhaust vent only.

Air Vent 500 Passive Exhaust Ventilation

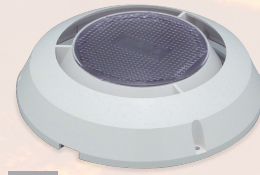

99

Marinco offers the AirVent 500 as a non-solar ventilation option that can passively move 600 to 1,000 cubic feet of air per hour in a 15 knot breeze. Marinco's engineering expertise created this vent to be strong, compact and effective.



VENTILATION

Cowl Vents



100

Cowl Vents are available in both low profile and standard height contours. These vents are a perfect air intake supplement to solar ventilation, and are also commonly used as a bilge ventilating system with or without a mechanical blower.

Clam Shell Vents

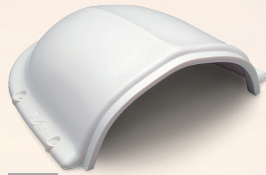

101

Clam shell vents are ideal for ventilation needs where a taller vent would foul lines or restrict crew movement. These vents work well as stern mounted ventilators for engine compartments.

Deck Plates

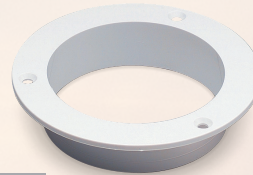

101

Deck plates are used to attach ventilators to the deck, hatch or hose. These plates create a clean installation and can be used with multiple material thicknesses.

Fans



102

Maringo fans provide cabin comfort by direct wiring into a 12V DC system. Multiple models are available to accommodate different installations.



Properly ventilated vessels provide for a more comfortable environment aboard and eliminates the accumulation of dangerous fumes.

TECH TIP

Ventilation Explained

Maintenance Ventilation

In most climates, boats that have been closed for a period of time will become “stuffy.” The temperature differential that develops between the boat cabin and the outdoor environment will cause the humidity level inside the boat cabin to rise. When the humidity level in the closed cabin rises, moisture forms, resulting in mold, mildew and musty air. In these conditions, fabrics, boat electronics and even the boat’s fiberglass structure can be damaged. By consistently replacing trapped, stale air in the closed boat with fresh outside air, the humidity equalizes from inside to outside, resulting in effective maintenance ventilation.

Comfort Ventilation

Combining different types of vents, with one vent providing “intake” air flow while another vent provides “exhaust” air flow, creates cross-flow ventilation. A cross-flow ventilation system will make the interior cabin more comfortable and pleasurable because air is constantly moving throughout the cabin. No matter what your boat size or cabin configuration is, you can increase your boating enjoyment with the addition of ventilation.

Safety Ventilation

Most boaters are unaware of the hazards that exist in the boating environment. Any number of serious ventilation problems can occur when a boat is left unattended. And even if you are underway, these problems don’t go away. Fumes and gasses, ranging from carbon

monoxide to hydrogen gas from battery charging, to gasoline, propane or solvents stored below, are unpleasant, and can sometimes be dangerous. Also, any open flame devices in the cabin require proper ventilation. Ventilation helps to eliminate these hazards by providing constant air circulation resulting in effective safety ventilation.

How Much Ventilation Is Required For Your Boat?

Ideally, the air in the interior of a boat should be circulated once every hour. A typical 30-foot boat contains approximately 800 cubic feet of air. As you will see, our solar powered models can move between 600 and 1,000 cubic feet of air every hour. The general guidelines for providing maintenance ventilation are as follows:

Boat Size	Recommended Ventilation
Up to 24’.	1 Exhaust Vent*
24’ to 40’.	1 Exhaust Vent & 1 Intake Vent
40’ and larger	2 Exhaust Vents & 1 Intake Vent

* For effective maintenance ventilation, one vent assumes there will be access for air to get into the cabin (i.e., cowl vent, clamshell vent or louvered panel)

It is important to evaluate the cabin layout of your boat to determine optimal locations for both intake and exhaust ventilation. These illustrations suggest placement for Marinco® solar powered vents and Marinco® passive vents.

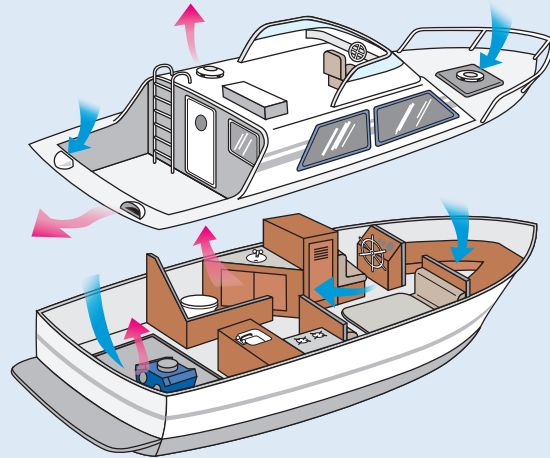
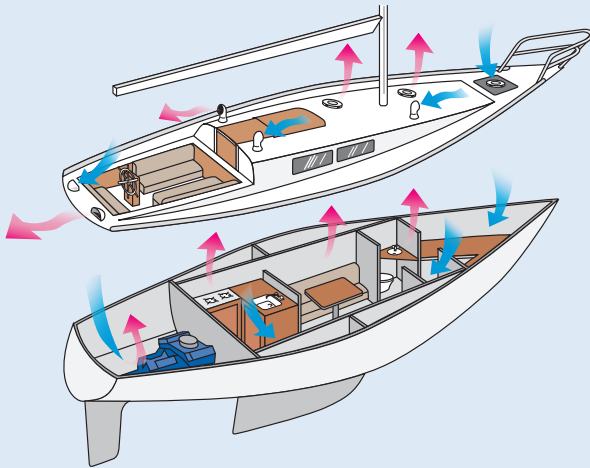

To specifically calculate your boat’s air volume, use this simple formula:

$$A \times B \times C \times 70\% = \text{Boat Interior Volume}$$







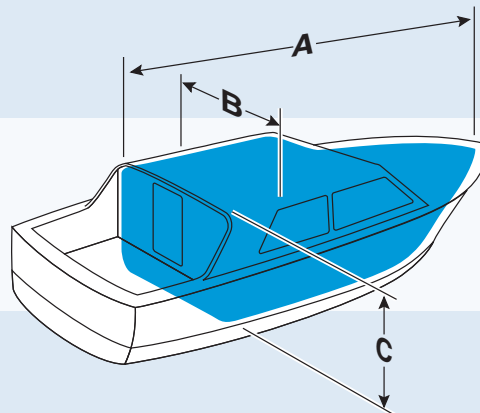



















A Dimension is the interior length (excluding cockpit)

B Dimension is the boat width

C Dimension is the average interior height



Ventilation Selection Chart

	Airflow Size	Hole Size Diameter	Deck Plate	Mounting Flange Depth	Operation		Cubic Feet of Air	Intake	Exhaust
					Day	Night			
	4" / 102 mm	4-3/4"	Screw-In (6" Outer Diameter)	2.75"	 Solar	 Rechargeable Battery Power	1000 ft ³ /hour 28 m ³ 24,000 ft ³ /day 680 m ³	 Fan (switch)	 Fan
	3" / 76 mm	3-3/4"	Screw-In (5" Outer Diameter)	2.75"	 Solar	 Rechargeable Battery Power	800 ft ³ /hour 23 m ³ 19,200 ft ³ /day 550 m ³	 Fan (switch)	 Fan
	3" / 76 mm	3-3/4"	None (Direct to Deck Mounting)	1"	 Solar	 Passive	700 ft ³ /hour 20 m ³ 5,600 ft ³ /day 160 m ³	Exhaust fan only	 Fan
	3" / 76 mm	3-3/4"	None (Direct to Deck Mounting)	1"	 Passive	 Passive	600 ft ³ /hour 17 m ³ In a 15 Knot Breeze	 Passive	 Passive
	4" / 102 mm	4-3/4"	Snap-In (6" Outer Diameter)	1"	 Passive	 Passive	—	 Passive	 Passive
	3" / 76 mm	3-3/4"	Snap-In (5" Outer Diameter)	1"	 Passive	 Passive	—	 Passive	 Passive

TECH TIP

Vent Installation Explained

Installation

All Marinco® ventilation products include clear, easy-to-understand installation instructions. These instructions address all of the key factors of a professional installation, such as:

- Proper hole measurement and cutting procedures
- Proper deck plate installation
- Use of sealants to waterproof your vent installation
- Installing vents in hatches
- Installing vents in "cambered" or slightly curved decks

Use of interior trim rings to "dress up" the cabin

The high quality level of Marinco Ventilation products must be combined with a sound installation to guarantee that your vent performs in all conditions. Marinco will make sure that your installation will be easy and successful so that you can enjoy the benefits of installation for a long time to come.

Marinco® Ventilation Installation Systems

Snap-In Deck Plate Installation

The 12V vent, 12V combo vent and cowl vents use the Marinco Snap-In deck plate system. The snap-in system allows the easy exchange of any snap-in part for upgrading or convenience, as well as the use of a snap-in cover that completely seals the deck plate making it water tight.

Direct-To-Deck Installation

The Day/Night Plus, MiniVent 1000 and AirVent 500 are designed to be installed directly to the deck without the requirement for a deck plate. All of these vent systems have built-in shut-off dampers that operate from below.

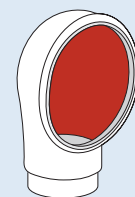

Deck Plate



Deck



Plastic Interior Trim Ring

Day/Night Solar Vent

- Circulates fresh air in boat cabin eliminating mold, mildew and musty air
- Moves 1,000 cubic feet of air/hour or 24,000 cubic feet of air/day (4" model)
- Rechargeable battery allows for 24-hour continuous operation
- No wiring required
- Built-in on/off fan switch, LED lights and intake/exhaust switch
- High capacity NiMh battery operates vent for up to 24-hours without sunlight on a full charge
- Threads into included deck plate and can be removed from outside without tools
- Complete air and green water shut-off from below
- All Day/Night Plus models come complete with white plastic interior trim ring, insect screen, mounting hardware and an easy-to-understand installation manual
- **Replaces NICRO 3" & 4" snap-in deck plates (fits existing holes once snap-in deck plates are removed)**

Description	Part #
3" White	N20803W
3" Stainless Steel	N20803S
4" White	N20804W
4" Stainless Steel	N20804S



Replacement NiMh Battery

- High capacity battery pack
- 4.8V, 2.5 amp-hours
- Replacement battery pack for current Day/Night Vents



Part # N20890

Solar Vent Cap

- Includes screw-in watertight cap



Description	Part #
for 3" vents	N20803CAP
for 4" vents	N20804CAP

Replacement Trim Ring



Description	Part #
for 3" vents	N20803RING
for 4" vents	N20804RING

Original Day/Night Plus Vent Accessories

Replacement NiMh Battery

- High capacity C-cell battery
- 1.2V, 2.8 amp-hours
- Replacement battery for older Day/Night Plus Vents, as well as, older model PowerVent 3000 and Day/Night 2000 Vents

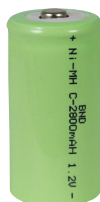

Part # N20790

MiniVent 1000

The MiniVent 1000 is the smallest and most economical solar vent in the Marinco® line. At just 7" in diameter and approximately 1-3/4" high, the MiniVent 1000 is compact yet effective. This solar powered model is an exhaust vent only. It will keep the boat cabin cool when you need it most, during the hot sunlight hours. Under solar power, the MiniVent 1000 will move 700 cubic feet of air an hour. At night, even a light breeze will continue to ventilate the boat passively.

Built-in shut-off damper prevents water intrusion in rough seas. Fits a 3-3/4" diameter installation hole. The vent can be retrofitted to an existing hole of up to 6" in diameter. Available in white ABS plastic or stainless steel. Optional stainless steel cover is also available separately.

- Solar powered exhaust ventilation during daylight and passive exhaust at night
- No batteries or wiring required
- Whisper-quiet fan operation
- Durable white ABS construction
- Shut-off damper to prevent water intrusion in rough seas
- Dimensions: 7" diameter X 1-3/4" high
- All MiniVent 1000 models come complete with white plastic interior trim ring, mounting hardware and an easy-to-understand installation manual

Description	Part #
3" White	N20020
3" Stainless Steel	N20030

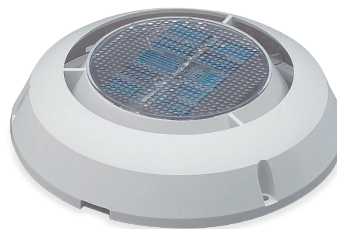

2 YEAR WARRANTY

Air Vent 500 Passive Exhaust Ventilation

Marinco® offers the AirVent 500 as a non-solar ventilation option that can passively move 600 to 1,000 cubic feet of air per hour in a 15 knot breeze. Marinco's engineering expertise created this vent to be strong, compact and effective. The AirVent 500 is an economical way to provide ventilation in your boat or it can be used in conjunction with other solar powered or 12V vents to create cross flow air circulation.

- Compact size: 7" diameter x 1-3/4" high
- High air flow volume 1,000 cu. ft./hour in a 15 knot breeze
- Strong U.V. stabilized white ABS construction
- Center panel is translucent plastic allowing light to pass through it below deck
- Center damper shuts vent off from below
- Easy installation – attaches directly to deck in compact 3-3/4" diameter hole and can be retrofitted to an existing hole of up to 6" in diameter

Part # N28810



2 YEAR WARRANTY

Cowl Vents

Cowl Vents are available in both low profile and standard height contours. These vents are a perfect air intake supplement to solar ventilation, and are also commonly used as a bilge ventilating system with or without a mechanical blower. Marinco® was the first supplier of soft, durable PVC vents that are flexible and safe. For interchangeability, Marinco 4" cowl vent models fit into the same 4" Snap-In deck plates used by the combo and 12V vents (3" or 4" sizes).

- Soft and durable PVC construction returns to original shape if stepped on
- Safer than metal cowl vents – prevents injury and resists snagging lines
- Snap-In vents include deck plate and cover
- 4" models interchangeable with Marinco® Combo and 12V Vent 4" snap-in deck plates
- Marinco adapter accessories make installing below-deck duct hose easy

Snap-In Deluxe Low Profile PVC Cowl Vent

- White with bright red interior
- Available in 3" or 4" sizes
- 3" size measures 4-1/2" high
- 4" size measures 5-1/2" high
- Includes white Snap-In deck plate and cover

Description	Part #
3"	N10863
4"	N10864



Snap-In Deluxe Standard PVC Cowl Vent

- White with bright red interior
- Available in 3" or 4" sizes
- 3" size measures 8" high
- 4" size measures 10" high
- Includes white Snap-In deck plate and cover

Description	Part #
3"	N10963
4"	N10964



Clam Shell Vents

- Ideal for ventilation needs where a taller vent would foul lines or restrict crew movement
- Work well as stern mounted ventilators for engine compartment
- Can be used for cabin ventilation with dorade boxes
- Flexible PVC construction
- Small clam shell dimensions - Inner : 2-1/2" H x 4-1/2" W x 5" L
Outer: 2-3/4" H x 6" W x 5-1/2" L
- Large clam shell dimensions - Inner : 3" H x 5-3/8" W x 6" L
Outer: 3-1/2" H x 7" W x 6-3/4" L

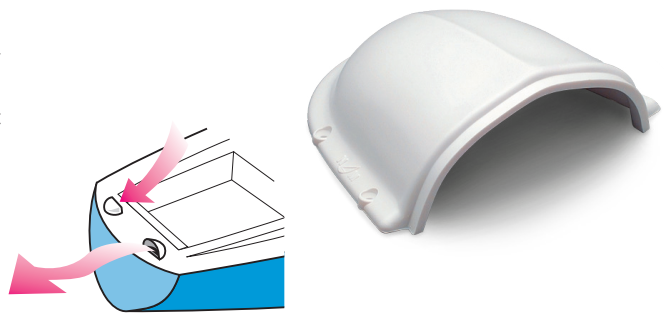

Description	Part #
Small	N10873
Large	N10874

White Snap-In Deck Plate

- Includes Snap-In watertight cover
- Use with any Marinco® Snap-In vent system
- N10863DW requires a 3-3/4" diameter hole cutout
- N10864DW requires a 4-3/4" diameter hole cutout

Description	Part #
3"	N10863DW
4"	N10864DW

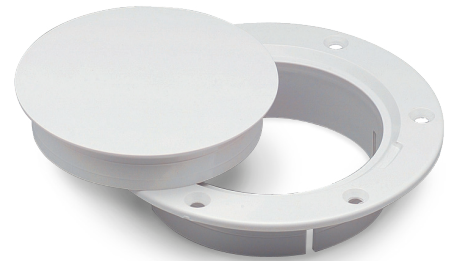

Plastic Interior Trim Ring

- Finishes off interior installation of vent
- Can be installed in decks between 1" and 2" thick
- Available in 3" and 4" sizes
- White plastic construction
- **Note: Interior trim rings are not compatible with threaded deck plates**

Description	Part #
3"	N10866
4"	N10867



Thru Bulkhead Hose Adapter

- For termination attachment of hose to bulkhead
- For attaching hose to cowl vent
- Can be used with Snap-In or threaded deck plates
- For use in decks or bulk heads of more than 1" thick

Description	Part #
3"	N10869
4"	N10870

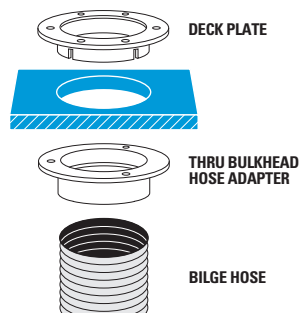



1 YEAR
WARRANTY

Marine Fan

- 120° adjustable oscillating fan
- Can be set for stationary operation
- Mount on wall, ceiling or dash
- Built-in on/off switch
- Installation hardware included
- 12V DC operation, 1.2A draw
- Translucent fan blades
- 7.5" vinyl-coated fan guard
- Mounting base dimensions: 3.375" L x 1.5" W
- Stands 8" from mounting surface

Part # 900



1 YEAR
WARRANTY

Personal Fan

- 180° adjustable swivel fan
- Mount on wall, ceiling or dash
- Built-in on/off switch
- Installation hardware included
- 12V DC operation, 0.5A draw
- Compact design installs anywhere
- Great for windshield defogging
- Base Dimensions: 3" diameter
- Stands 5" from mounting surface

Part # 903-5



PN	Page	PN	Page	PN	Page	PN	Page	PN	Page
10001	85	104SPP-25.OEM	23	11095	82	12VBRAD	45	150BBI-TM	54
10010	86	104SPP-50.OEM	23	11096	81	12VBRAD.OEM	45	150BBI.OEM	54
10011	86	104SPP.OEM	23	11098	85	12VBRS2	45	150BBIW	54
10017XL	86	104SPPG	23	110A	23	12VBRS2.OEM	45	150BBIW.OEM	54
10018XL	86	10524	87	110R	27	12VBRS3	44	150PHB	54
10028XLP	86	105SPP	23	11106	87	12VBRS3.OEM	44	150PHW	54
10029XLP	86	105SPPG	23	11107	87	12VCOMBO	43	150SPP	23
10031	83	10624	87	11114	87	12VCOMBO-B	43	151225	18
10035	85	106A	23	11117	87	12VCOMBON-B	43	151250	18
10036	85	10MSPPXP	33	11124	82	12VCOMBOW-B	43	1520BI.OEM	31
10079	82	11-004-N	93	11168	83	12VCP	45	152AY	24
10080	81	11017XLP	86	11185	84	12VCP6	45	153AY	24
10082	84	11018XLP	86	11187	81	12VCPS2	45	154AY	24
10098	85	11028XLP	86	11188	81	12VCPS3	44	157AY	24
10099	85	11029XLP	86	11190	82	12VDUSB	43	1591-FI	30
100EL	27	11031	83	11191	82	12VDUSB-B	43	1591-FI.GRY.OEM	30
100R	27	11034	83	11196	81	12VDUSB48	43	1591-FI.WHITE	30
10102	87	11035	85	111A	23	12VDUSBN-B	43	15M32AX	34
10104	87	11045	83	11225	82	12VDUSBW-B	43	15M32AXP	34
10105	87	11058	84	11226	82	12VPG	41	15MSPPX	33
10106	87	11059	84	115A	23	12VPG.OEM	41	15MSPPXP	33
10107	87	11064	84	117A	23	12VPK	41	162AY	24
10108	87	11066	84	118A	23	12VPL.OEM	42	165AY	24
10122	87	11079	82	121A	23	12VRC	41	199109PK	29
101739	32	11079SC-B	82	12224	87	12VRC.OEM	41	199110PK	29
102164	32	11079SC-SS	82	123A	23	12VRC.PG	41	199111PK	29
102167	32	11079SC-W	82	12BKT	42	12VRCO	41	199114	33
102182	29	11079SN-B	82	12MP.OEM	42	12VRCY	41	199115	34
10224	87	11079SN-W	82	12VBP	45	12VTR	47	199116	17
102N	27	11080	81	12VBP.OEM	45	12VTR.OEM	47	199117	17
103ELN	27	11080SC-B	81	12VBPS2	45	12VXT	42	199117G	17
103RN	27	11080SC-SS	81	12VBPS2.OEM	45	150025	18	199119	17
103RN.OEM	27	11080SC-W	81	12VBPS3	44	150025NL	18	199119G	17
103RNX	33	11088	83	12VBPS3.OEM	44	150050	18	199120	17
103RNXPK	33	11090	82	12VBR	45	150050NL	18	199128	26
104SPP	23	11091	82	12VBR.OEM	45	150BBI	54	199136	11

PN	Page	PN	Page	PN	Page	PN	Page	PN	Page
1M32AXP	34	2111A-O	59	2606A-B	53	303SSRCDPL.OEM	14	32114B	76
1MSPPXP	33	22011A-P	92	2701A	52	304EL-B	11	32116B	76
1RPC	26	22012A-P	92	2707A	51	304EL-B.NT	11	32118B	76
1RPC50	26	22014-P	92	2708A	51	304EL-B.OEM	11	32120B	76
1RPC50SP	25	22040A	92	2710A	51	304EL-BX	33	32122B	76
1RPCSP	25	22041A	92	2711A	51	304EL-BX.NT	33	32124B	76
20036	41	22050A	91	2713A	51	3050BI	11	33006A	72
200BBIW.OEM	54	22051A	91	2720A	51	305BC	46	33006A	73
2018BP-12	46	22150A	91	2731A	51	305BP	46	33007A	72
2018BP-24	46	22151A	91	2740A	51	305BP.OEM	46	33007A	73
2018BP-24.OEM	46	22200	92	27505	55	305CRCN	27	33010A	72
2018BR	46	22201	92	27515	55	305CRCN.OEM	27	33010A	73
2018BR-MB	46	22208A	92	30000	71	305CRCN.VPK	27	33012A	72
2018BR.OEM	46	22209	92	30002	71	305CRCXN	33	33012A	73
2018BR.OEM.BPS	46	22224	87	30004	71	305CRCXNPK	33	33014A	72
2018MB	46	22240-R	92	30005	71	305CRMB	32	33014A	73
2018MB.OEM	46	22250-HH	91	300275	42	305CRPN	27	33025	69
2018PKG	46	22250-R	91	301BKRPL.OEM	14	305CRPN.OEM	27	33032A	72
202319	90	22350-R	91	301CRMB	32	305CRPN.VPK	27	33032A	73
202320	90	2300A	59	301EL-B	11	305CRR	27	33037A	72
205CRCN	31	2300A-B	59	301EL-B.BLACK	11	305CRRB	27	33037A	73
205CRPN	31	2303A	59	301EL-B.FR	11	305CRRB	46	33070A	72
205CRR	31	2303A-B	59	301EL-B.GRAY	11	305CRRB.OEM	27	33070A	73
20MSPPX	33	2304A	59	301EL-B.OEM	11	305CRRB.OEM	46	33084W	72
20MSPPXP	33	2304A-B	59	301EL-B.W/L	11	31000	71	33084W	73
2100	59	23050A	91	301EL-BX	33	32000	71	33086W	72
2100-B	59	23051A	91	301EL-BXPK	33	32001	71	33086W	73
2101	59	23150A	91	301ELCB	11	32002	71	33090	72
2101-B	59	23151A	91	301RCDKITIGN.OEM	14	32012B	76	33090W	72
2102	59	23250-HH	91	301RCDPL.OEM	14	32014B	76	33092	72
2102-B	59	23250-R	91	303SSBKRPL.OEM	14	32016B	76	33092W	72
2110A	59	23350-R	91	303SSEL-B	11	32018B	76	33092W	73
2110A-B	59	25MSPPXP	33	303SSEL-B.OEM	11	32020B	76	33094	72
2111A	59	25SPPW	17	303SSEL-BX	33	32022B	76	33101	71
2111A-17	59	25SPPX	33	303SSEL-BXPK	33	32024B	76	33106A	72
2111A-B	59	2603-B	53	303SSO	11	32112B	76	33106A	73

PN	Page	PN	Page	PN	Page	PN	Page	PN	Page
33107A	72	34014S	76	36161	68	5369CR	31	6360CRN.OEM	28
33107A	73	34015	69	36180	68	5369CR.OEM	31	6360CRNX	34
33110A	72	34016B	76	37100	68	6017	31	6360CRNXPk	34
33110A	73	34016S	76	37110	68	6018	31	6361CRN	28
33112A	72	34018B	76	37111	68	6079	32	6364CRN	28
33114A	72	34018S	76	37161	68	6080	32	6364CRN.OEM	28
33114A	73	34020B	76	37180	68	6083CR	32	6365CRN	28
33125	69	34020S	76	37181	68	6084CR	32	6365CRN.OEM	28
33132A	72	34022B	76	37200	68	6152SPP	17	6369CR	28
33132A	73	34022S	76	38000	69	6152SPP-12SC	17	6369CR.OEM	28
33137A	72	34024B	76	38001	69	6152SPP-25	17	6370CR	28
33137A	73	34024S	76	38005	69	6152SPP-75	17	6371EL	12
33170A	72	34026B	76	38010	69	6152SPPG	17	6371EL-B	12
33170A	73	34026S	76	38011	69	6152SPPG-25	17	6371EL-B.OEM	12
33184W	72	34112B	76	4006	58	6152SPPW	17	6371EL-BX	34
33184W	73	34112S	76	4008	58	6152SPPW-25	17	6371ELX	34
33186W	72	34114B	76	4012	58	6152SPPW-55.P/O	17	6373EL	13
33186W	73	34114S	76	4018	58	6152SPPW-75.P/O	17	6373EL-B	13
33190	72	34116B	76	4700CR	30	6153SPP	17	6373EL-B.OEM	13
33192	72	34116S	76	4721CR	30	6153SPP-25	17	6373EL-B.W/L	13
33192W	73	34118B	76	4731CR	30	6153SPP-75	17	6373EL.OEM	13
33194	72	34118S	76	500, 500A	92	6153SPPW	17	6373ELMB	32
33505	77	34120B	76	500EL	29	6153SPPX	34	6401CRCX	35
33513	77	34120S	76	500R	29	6343EL-BX	34	6401CRPX	35
33515	77	34122B	76	501, 501A	92	6344EL-B.NT	13	6401EL-BX	35
33517	77	34122S	76	502-1	92	6351EL	12	6402CRCX	35
33901	76	34124B	76	503, 503A	92	6351EL-B	12	6402CRPX	35
33919	76	34124S	76	50SPP.OEM	17	6351EL-BX	34	6402EL-BX	35
34000	69	34126B	76	50SPPW.OEM	17	6353EL	13	71011	66
34001	69	34126S	76	50SPPX	33	6353EL-B	13	71012	66
34005	69	34210	69	510R	29	6353EL-B.BLACK.OEM	13	71081	66
34010	69	35010	70	5262CRR	30	6353EL-B.GRAY	13	71082	66
34011	69	35040	70	5262CRR.GRY	30	6353EL-B.OEM	13	71112	66
34012B	76	35SPP	17	5266CR	30	6353ELCB	13	71182	66
34012S	76	36110	68	5269CR	30	6353RCDKITIGN.OEM	14	729493	92
34014B	76	36111	68	5366CR	31	6360CRN	28	729494	92

PN	Page	PN	Page	PN	Page	PN	Page	PN	Page
729823-P	92	83112	67	M4100P12	36	N28810	99	SPL-12C	90
729825	92	83181	67	M4100R12	36	OEM #	18	SPL-12C.OEM	90
729829-P	92	83182	67	M5100B9R	37	P-11D03	58	SPL-12W	90
729830-P	92	900	102	M5100C9	37	P-11D04	58	SPL-12W.OEM	90
7420CR	32	903-5	102	M5100C9R	37	P-12D34	58	SPL-24B.OEM	90
7420CR.OEM	32	BAG	19	M5100P9	37	P-12D35	58	SPL-24C.OEM	90
75SPP.OEM	17	CCVR-24	19	M5100R9	37	P-12D36	58	SPL-24W.OEM	90
76030	77	CLIP	19	ML-005BW-STC	93	P-12D37	58	SPLR-1 (OPTIONAL)	90
76080	70	CLIP-01	19	ML-005BW/DSP	93	P-13A27	58	SPLR-2 (INCLUDED)	90
76090	70	CS1004	36	ML-005NWW	93	P-13A28	58	SPLR-3 (OPTIONAL)	90
76130	77	CS100IT4	36	ML-005WW-STC	93	P-13A29	58	STRAP	19
76180	70	CS100IT5	37	ML-005WW/DSP	93	P-13A2A	58	TV6444	15
76190	70	CS30-12	16	N10863	100	P15-30	22	TV6574	15
7715CRN	29	CS30-25	16	N10863DW	101	P15-30-25	22	TV6592	15
7715CRN.OEM	29	CS30-50	16	N10864	100	P15-30-25W	22	TV6592.OEM	15
7715CRNX	34	CS30-50W	16	N10864DW	101	P30-15	22	TV97.OEM	18
7715CRNX	35	CS503-25	16	N10866	101	P30-503	22	TV99-25	18
7715CRNXPK	34	CS503-50	16	N10867	101	P30-504	22	TV99W	18
7715CRNXPK	35	CS504-25	16	N10869	101	P503-30	22	TVHD	18
7715ELN	29	CS504-50	16	N10870	101	P504-30	22	U-3605	92
7715ELN.OEM	29	CS504-50W	16	N10873	101	P504-503	22	Y30-2-30	24
7717N	29	CS50EXT4*	36	N10874	101	PH6574TV	15	Y503-2-30	24
7717N.OEM	29	CS754	36	N10963	100	PH6574TV.W/L	15	Y504-2-30	24
7788CR	32	CS75IT4	36	N10964	100	PH6592TV-SS	15	Y504-2-503	24
7879CR	32	CS75IT5	37	N20020	99	PH6592TV-SS.OEM	15	Y504-2-504	24
7879CR-FI	32	CW1004	36	N20030	99	PH6597TV	18		
7879CR-FI.OEM	32	CW100IT4	36	N20790	98	PH6599	18		
82012	65	CW100IT5	37	N20803CAP	98	PHTV6599	18		
82082	65	CW125IT4	36	N20803RING	98	RY504-2-30	25		
82182	65	CW125IT5	37	N20803S	98	S15-30	21		
82312	65	CW754	36	N20803W	98	S15-504	21		
83011	67	M051A-SS	93	N20804CAP	98	S20-15	21		
83012	67	M051B	93	N20804RING	98	S20-30	21		
83081	67	M051B-SS	93	N20804S	98	S30-15	21		
83082	67	M4100B12R	36	N20804W	98	SPL-12B	90		
83111	67	M4100C12	36	N20890	98	SPL-12B.OEM	90		

Ingress Protection (IP) Ratings Guide











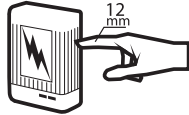

Example:

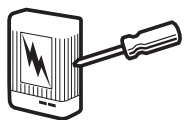
An IP65 rating can be determined using the adjacent table and example:

- The first number of the rating example, 6, in the gray column means the enclosure is dust tight
- The second number of the rating example, 5, in the blue column means the enclosure is protected against jets of water

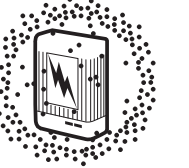
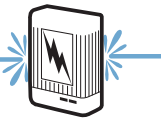
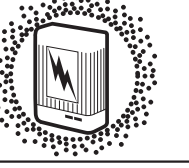
The IP rating system was established by the International Electrotechnical Commission (IEC), an organization for international standards and conformity assessment. The IEC collaborates closely with the International Organization for Standardization (ISO). A complete description of the IP ratings and associated tests is found in IEC Publication 529. Although these ratings were initially developed as a way to classify enclosures, they now provide a convenient, practical way to compare levels of sealing. Many electrical products have an Ingress Protection (IP) rating which identifies the environmental factors needing consideration prior to the product's installation.

This is important when deciding when to mount products in a dry and clean environment versus a wet and/or dusty environment. The IP rating indicates the degree of protection provided. The numbers following IP represent levels of sealing and can range from no protection to full protection against dust and water. The table provides a description of the protection at each level.

SOLIDS		WATER	
1	 Protected against a solid object greater than 50 mm such as a hand.	1	 Protected against vertically falling drops of water. Limited ingress permitted.
2	 Protected against a solid object greater than 12 mm such as a finger.	2	 Protected against vertically falling drops of water with enclosure tilted up to 15 degrees from the vertical. Limited ingress permitted.
3	 Protected against a solid object greater than 2.5 mm such as a screwdriver.	3	 Protected against sprays of water up to 60 degrees from the vertical. Limited ingress permitted for three minutes.
4	 Protected against a solid object greater than 1 mm such as a wire.	4	 Protected against water splashed from all directions. Limited ingress permitted.
5	 Dust Protected. Limited ingress of dust permitted. Will not interfere with operation of the equipment. Two to eight hours.	5	 Protected against jets of water. Limited ingress permitted.
6	 Dust tight. No Ingress of dust. Two to eight hours.	6	 Water from heavy seas or water projected in powerful jets shall not enter the enclosure in harmful quantities.
		7	 Protection against the effects of immersion in water between 15 cm and 1 m for 30 minutes.
		8	 Protection against the effects of immersion in water under pressure for long periods.

Rating Example:

IP65

INGRESS PROTECTION

Marinco

N85 W12545 Westbrook Crossing
Menomonee Falls, WI 53051 USA
p 800.307.6702
f 800.799.3779

New Zealand

42 Apollo Drive
Rosedale, Auckland 0632
New Zealand
p +64.9.415.7261
f +64.9.415.9327

The Netherlands

Snijdersbergweg 93
1105 AN Amsterdam
The Netherlands
p +31(0)20 34 22 100
f +31(0)20 69 71 006

tech.marinco@oneasg.com
marinco.com

©2023 Marinco
All rights reserved

Unauthorized copying or
reproduction is a violation
of applicable laws.

MAR_CAT_003_0722